



ligar e sentir

connect and feel



*Somos os inventores da
hidro-salamandra*



*We are the inventors of
the pellet hydro-stove*

conteúdo

table of contents

7

História
History

8

Líder tecnológico
Technology Leader

9

**Respeito pelo
meio ambiente**
*Respect for
the environment*

96

Depósitos de água
Water tanks



10

Ar *Air*

Salamandras / Stoves

- 16. Miami
- 17. Creta
- 18. Moon II
- 19. Lyon
- 22. Monaco
- 23. Vigo III
- 25. Keops
- 26. Marsella
- 27. Praga
- 28. Tokio
- 29. Eco I
- 32. Atenas
- 33. Nature

Recuperadores / Inserts

- 36. Eco Mini Insert
- 37. Cordoba Glass
- 38. Cordoba
- 39. Eco I Insert

40

Ar canalizável *Ductable air*

Salamandras / Stoves

- 46. Bolonia
- 47. Ibiza
- 48. Dubai
- 49. Roma
- 53. Venecia Bambú
- 54. Kiev
- 55. Oslo

Recuperadores / Inserts

- 58. Cordoba Glass Canalizable
- 59. Cordoba Canalizable
- 60. Granada
- 61. Teide
- 62. Boston Insert
- 63. Milán
- 64. Kiev Insert
- 65. Oslo Insert

66

Água *Water*

Salamandras / Stoves

- 70. Hidrocooper 18
- 71. Hidrocooper 18 Slim
- 72. Hidrocooper 18 Slim Plus
- 73. Hidrocooper 24 Slim

Recuperadores / Inserts

- 74. Dublin II
- 75. Super Insert II

76

Caldeiras pellets *Pellet boilers*

- 78. Cantina Compact
- 79. Cantina Super
- 80. Cantina Nova
- 81. Vap 5-20
- 82. Vap 24
- 84. Vap 30
- 85. Vap 100

86

Lenha *Wood*

Salamandras / Stoves

- 88. Arlés

Recuperadores / Inserts

- 89. Eco Insert 90
- 90. EcoGlass Insert 90

Hidro recuperador / Hydro Insert

- 91. Moscú

92

Caldeiras lenha *Wood boilers*

- 94. Madeira
- 95. Fortaleza

100

Silos e sistemas de alimentação *Silos and feeding system*



História

O grupo de empresas Vapormatra-Ecoforest foi fundado em Vigo em 1959 pelo seu proprietário e fundador José Carlos Alonso Martínez. Depois de viajar para Nova Iorque em 1958, com o motivo da primeira feira mundial multissetorial, iniciou a sua carreira profissional comercializando caldeiras a vapor, queimadores e produtos para o sector do aquecimento.

Graças a este espírito empreendedor e a uma enorme visão comercial, na década de 1970, visitou as feiras internacionais mais importantes do setor para trazer para o mercado nacional todos os avanços e novidades do momento e a partir daqui foi criada a primeira caldeira de biomassa sob a forma de astilla de madeira. Desta forma, o Grupo Vapormatra-Ecoforest foi o primeiro a demonstrar o seu interesse pela ecologia e economia de combustível.

Em 1993, num esforço para continuar a acrescentar valor ao mercado, foi lançado um novo desafio profissional; trazer um novo produto para o mercado que fosse ecológico e acima de tudo, económico. Para o efeito, criou a primeira fábrica de pellets em Villacañas (Toledo) e introduz a sua nova invenção no mercado europeu: a primeira estufa-caldeira de pellets.

Atualmente, a Ecoforest é a empresa líder no mercado com a mais ampla gama de fogões de pellets a ar, gama de fogões de ar canalizado, fogões e caldeiras de água, com presença em mais de 36 países. O seu empenho e investimento constante em I+D+I, continua a ser um dos pilares da exploração.

History

The Vapormatra- Ecoforest company group is born in Vigo in 1959 thanks to its owner and founder José Carlos Alonso Martínez. After traveling to New York in 1958 because of the first multi-sector world fair, he starts his professional life commercializing steam boilers, burners and heating sector products.

In the seventies decade, thanks to a huge commercial vision and to his active spirit, he visits the most important international fairs of this sector to grant the most advanced products to the Spanish market, creating this way the first biomass boiler working with Madera / Wood chips. Thus the Vapormatra-Ecoforest group was the first one in showing its interest for ecology and fuel economy.

Still struggling to keep adding value to the market, in 1993 he proposes himself a new professional goal: to add a vanguard, ecologic and economical product to the world market. To achieve this, he creates the first pellet factory in Villacañas (Toledo) and brings his new invention to the European market: The first pellet water stove.

Nowadays, Ecoforest is the market leader with the broader range of air and ductable air stoves, water stoves and boilers, trading in more than 36 countries. Its commitment and continuous reinvestment in R&D is still one of the main pillars behind Ecoforest's success.





Líder
tecnológico

Technology
Leader

A Ecoforest conseguiu tornar-se num fabricante de referência no sector do Aquecimento e Climatização, graças ao seu forte empenho na Tecnologia e investimento em I&D. Isto tem contribuído para uma diversificação de clientes e o reforço das equipas de projecto através do desenvolvimento de diferentes produtos.

Actualmente, o principal desafio que o sector da Climatização enfrenta é a utilização eficiente dos recursos, que a natureza nos dá, bem como na integração de plataformas TIC (“Tecnologias de Informação e Comunicação”).

A estratégia da Ecoforest inclui a diversificação e o aumento do seu produto, serviço e tecnologia para responder às novas prioridades do setor.

Ecoforest has become a benchmark manufacturer within the heating and air-conditioning sector thanks to a strong commitment to technology and investment in R&D. It is also important to mention a differentiated geographical strategy, customer diversification and strengthening of project teams through the development of different products.

Nowadays the main challenge is the efficient use of the resources that Mother Nature grants and the integration of ICT (Information and Communication Technologies).

Ecoforest’s strategy includes diversifying and increasing its range of products, services and technology to answer the latest priorities of the sector.



Respeito pelo meio ambiente

Respect for the environment

O respeito e a protecção do meio ambiente tornou-se uma das principais questões do nosso tempo. A deterioração que o nosso planeta tem sofrido nos últimos anos é evidente em fenómenos como o aquecimento global, o aumento da desertificação e a extinção de certas espécies animais e vegetais.

A fim de melhorar as condições ambientais do nosso planeta e do nosso ambiente particular, devemos estar conscientes das consequências de uma gestão adequada dos nossos recursos naturais e dos efeitos imediatos e positivos que a nossa contribuição profissional pode ter.

Hoje em dia, todas as melhores técnicas no sector do Aquecimento e da Climatização apontam ao mesmo objectivo, aumentar a eficiência e reduzir as emissões poluentes.

A política de Qualidade e Ambiental da Ecoforest reflete o nosso compromisso para melhorar a satisfação dos nossos clientes e a preservação do ambiente, através de actividades de desenho, concepção e fabrico de equipamentos para Aquecimento e Climatização com reduzidas emissões.

The respect and protection of the environment has become one of the most important matters in the current times. The damage done to our planet in the last years can be seen in phenomena like global warming, desertification and extinction of different species of plants and animals.

To improve the environmental conditions of our planet and our personal environment, we have to be aware of the consequences that a proper management of our natural resources and of the prompt and positive effects that our professional contribution may have.

Nowadays the complete range of the heating and air-conditioning sector techniques has the same goal, to raise the efficiency and to lower polluting emissions.

Ecoforest's quality and environmental policies reflect the commitment to improve our customers' satisfaction and environment preservation by means of design and elaboration of heating and air-conditioning equipment with low polluting emissions.

Ar Air



A energia produzida pela combustão da biomassa é transmitida para o ar através de um permutador de alta eficiência e ventilada por um convetor para a sala a ser aquecida. Os produtos Ecoforest são concebidos para satisfazer as necessidades estéticas e energéticas de cada casa, com uma instalação fácil, rápida e económica.

The energy produced by the combustion of the biomass is transmitted to the air by means of a high-efficiency exchanger and it is propelled through a fan to the room to be heated. Ecoforest products are designed in such a way that they meet the aesthetic and energetic needs for each home with an easy, fast and economical installation.







Ajuste automático de queda de pellets e oxigênio de combustão



Design



Peças de reposição comuns para toda a gama



ecoSILENCE

VANTAGENS
ECOFOREST - AR



Adaptação policombustível



Mais comodidade: intercambiador de calor aletado em alumínio sem necessidade de limpeza diária



Gestão através da APP



Controlador intuitivo



Automated modulation of pellet drop and combustion oxygen



Design



Multifuel



User-friendly display



App management



More convenience: no need to clean the aluminium finned heat exchanger



ecoSILENCE

Common spare parts for the whole range

ADVANTAGES
ECOFEST - AIR

» info p17

Creta



Esta pequena salamandra de pellets oferece todas as características de toda a gama Ecoforest, mas com uma potência adaptada para casas pequenas. É também um fogão hermético, ideal para instalações em casas passivas e casas em zonas rurais.

This small pellet stove offers all the features of the entire Ecoforest range but with a power adapted for small homes. It is also an airtight stove, ideal for installations in passive houses and homes in rural areas.



Miami



A+



WIFI
INTERNET
APP
INCL.



eco
SILENCE



Estanque
Airtight



CARACTERÍSTICAS TÉCNICAS

Potência: 5,5 kW
Rendimento: 91,2 %
Depósito: 7 kg
Consumo: 0,7 - 1,2 kg/h
Autonomia: 11 - 6 h
Peso: 77 kg
Diâmetro saída de gases: 80 mm
Diâmetro entrada de ar: 30 mm
EEI=124

TECHNICAL SPECIFICATIONS

Power: 5,5 kW
Performance: 91,2 %
Hopper: 7 kg
Consumption: 0,7 - 1,2 kg/h
Autonomy: 11 - 6 h
Weight: 77 kg
Gas outlet diameter: 80 mm
Gas inlet diameter: 30 mm
EEI=124

INCLUI

Controlo automático do fornecimento de ar de combustão, dos pellets e ar de convecção / Eletrónica exclusiva Ecoforest / Controlo e programação por potência ou por temperatura ambiente com modulação da potência / Sistema de limpeza por vácuo / Múltiplos sistemas de segurança / Cesto em aço inoxidável / Intercâmbiador alhetado de alumínio sem necessidade de limpeza diária / Possibilidade de saída de fumo superior ou posterior (tubo interior não incluído).

INCLUDING

Automatic modulation of combustion air, pellets supply and convection air / Ecoforest exclusive electronics / Control and programming by power or by room temperature with power modulation / Vacuum cleaning system / Multiple safety systems / Stainless steel burning pot / Aluminium finned heat exchanger with no daily cleaning required / Possibility of top or rear exhaust outlet (internal flue pipes not included).

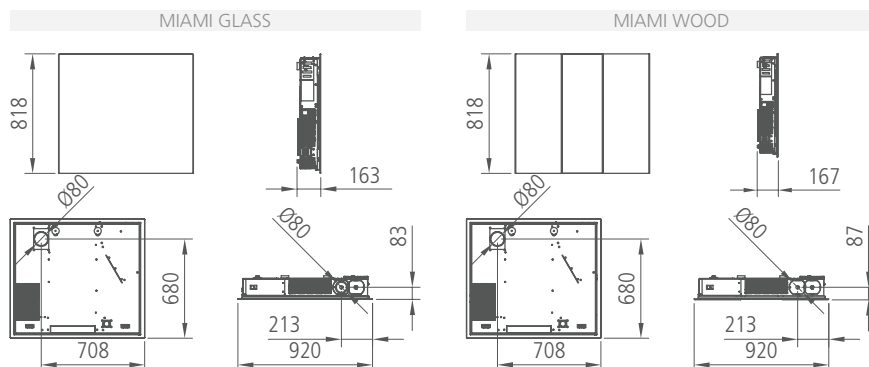

Creta



A+



WIFI
INTERNET
APP
INCL.



eco
SILENCE



Estanque
Airtight



CARACTERÍSTICAS TÉCNICAS

Potência: 6 kW
Rendimento: 91,2 %
Depósito: 11 kg
Consumo: 0,7 - 1,4 kg/h
Autonomia: 17 - 8 h
Peso: 71,5 kg
Diâmetro saída de gases: 80 mm
Diâmetro entrada de ar: 60 mm
EEI=125

TECHNICAL SPECIFICATIONS

Power: 6 kW
Performance: 91,2 %
Hopper: 11 kg
Consumption: 0,7 - 1,4 kg/h
Autonomy: 17 - 8 h
Weight: 71,5 kg
Gas outlet diameter: 80 mm
Gas inlet diameter: 60 mm
EEI=125

INCLUI

Controlo automático do fornecimento de ar de combustão, dos pellets e ar de convecção / Eletrónica exclusiva Ecoforest / Controlo e programação por potência ou por temperatura ambiente com modulação da potência / Policombustível (pellets, casca de amêndoa, caroço de azeitona) / Sistema de limpeza por vácuo / Múltiplos sistemas de segurança / Cesto queimador em ferro fundido / Intercambiador alhetado de alumínio sem necessidade de limpeza diária / Frontal e parte superior em vidro preto.

INCLUDING

Automatic modulation of combustion air, pellets supply and convection air / Ecoforest exclusive electronics / Control and programming by power or by room temperature with power modulation / Multifuel (pellets, almond shell, olive pit) / Vacuum cleaning system / Multiple safety systems / Cast iron burning pot / Aluminium finned heat exchanger with no daily cleaning required / Front and top in black tempered glass.

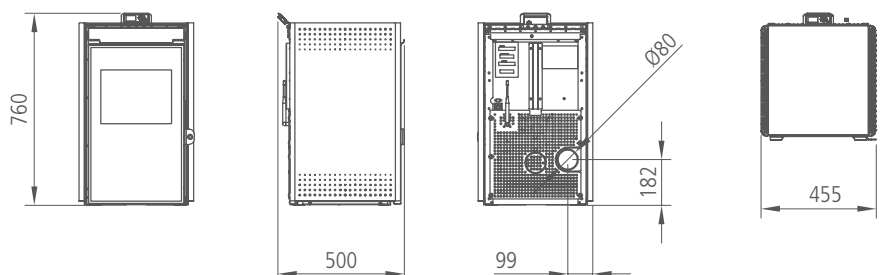

Moon II



A+



WIFI
INTERNET
APP
INCL.



eco
SILENCE



Estanque
Airtight



CARACTERÍSTICAS TÉCNICAS

Potência: 7,5 kW
Rendimento: 94 %
Depósito: 15 kg
Consumo: 0,5 - 1,7 kg/h
Autonomia: 28 - 8,9 h
Peso: 89 kg
Diâmetro saída de gases: 80 mm
Diâmetro entrada de ar: 60 mm
EEI=125

TECHNICAL SPECIFICATIONS

Power: 7,5 kW
Performance: 94 %
Hopper: 15 kg
Consumption: 0,5 - 1,7 kg/h
Autonomy: 28 - 8,9 h
Weight: 89 kg
Gas outlet diameter: 80 mm
Gas inlet diameter: 60 mm
EEI=125

INCLUI

Controlo automático do fornecimento de ar de combustão, dos pellets e ar de convecção / Eletrónica exclusiva Ecoforest / Controlo e programação por potência ou por temperatura ambiente com modulação da potência / Policombustível (pellets, casca de amêndoa, caroço de azeitona) / Sistema de limpeza por vácuo / Múltiplos sistemas de segurança / Cesto queimador em ferro fundido / Intercambiador alhetado de alumínio sem necessidade de limpeza diária / Frontal e parte superior em vidro preto.

INCLUDING

Automatic modulation of combustion air, pellets supply and convection air / Ecoforest exclusive electronics / Control and programming by power or by room temperature with power modulation / Multifuel (pellets, almond shell, olive pit) / Vacuum cleaning system / Multiple safety systems / Cast iron burning pot / Aluminium finned heat exchanger with no daily cleaning required / Front and top in black tempered glass.

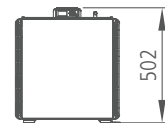
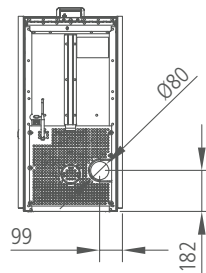
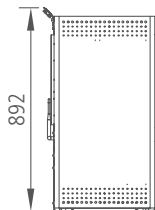
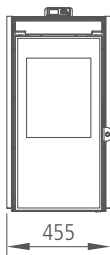

Lyon



A+



CARACTERÍSTICAS TÉCNICAS

Potência: 7,5 kW
 Rendimento: 93 %
 Depósito: 12 kg
 Consumo: 0,6 - 1,6 kg/h
 Autonomia: 19 - 7 h
 Peso: 78 kg
 Diâmetro saída de gases: 80 mm
 Diâmetro entrada de ar: 60 mm
 EEI=129

TECHNICAL SPECIFICATIONS

Power: 7,5 kW
 Performance: 93 %
 Hopper: 12 kg
 Consumption: 0,6 - 1,6 kg/h
 Autonomy: 19 - 7 h
 Weight: 78 kg
 Gas outlet diameter: 80 mm
 Gas inlet diameter: 60 mm
 EEI=129

INCLUI

Controlo automático do fornecimento de ar de combustão, dos pellets e ar de convecção / Eletrónica exclusiva Ecoforest / Controlo e programação por potência ou por temperatura ambiente com modulação da potência / Policombustível (pellets, casca de amêndoa, caroço de azeitona) / Sistema de limpeza por vácuo / Múltiplos sistemas de segurança / Cesto queimador em ferro fundido / Intercâmbiador alhetado de alumínio sem necessidade de limpeza diária / Câmara de combustão reforçada em vermiculite.

INCLUDING

Automatic modulation of combustion air, pellets supply and convection air / Ecoforest exclusive electronics / Control and programming by power or by room temperature with power modulation / Multifuel (pellets, almond shell, olive pit) / Vacuum cleaning system / Multiple safety systems / Cast iron burning pot / Aluminium finned heat exchanger with no daily cleaning required / Hearth with vermiculite.

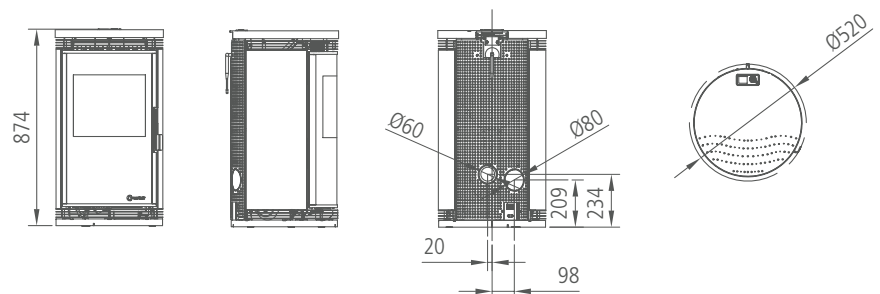

» info p22

Monaco



O modelo Mónaco é uma das salamandras mais estreitas, planas e compactas do mercado. É uma salamandra estanque com grande versatilidade quando se trata de instalar a saída de gases: pode instalar uma saída superior ou uma saída traseira de gases.

The Monaco model is one of the narrowest, flattest and most compact stoves on the market. It is an airtight stove with a flexible installation of the gas outlet: you can install a top outlet or a rear gas outlet.



Monaco



A+



WIFI
INTERNET
APP
INCL.



eco
SILENCE



Estanque
Airtight



CARACTERÍSTICAS TÉCNICAS

Potência: 7,5 kW
Rendimento: 94,4 %
Depósito: 11 kg
Consumo: 0,7 - 1,6 kg/h
Autonomia: 17 - 7 h
Peso: 97 kg
Diâmetro saída de gases: 80 mm
Diâmetro entrada de ar: 60 mm
EEI=127

TECHNICAL SPECIFICATIONS

Power: 7,5 kW
Performance: 94,4 %
Hopper: 11 kg
Consumption: 0,7 - 1,6 kg/h
Autonomy: 17 - 7 h
Weight: 97 kg
Gas outlet diameter: 80 mm
Gas inlet diameter: 60 mm
EEI=127

INCLUI

Controlo automático do fornecimento de ar de combustão, dos pellets e ar de convecção / Eletrónica exclusiva Ecoforest / Controlo e programação por potência ou por temperatura ambiente com modulação da potência / Sistema de limpeza por vácuo / Múltiplos sistemas de segurança / Cesto queimador em aço inoxidável / Intercambiador alheteado de alumínio sem necessidade de limpeza diária / Cesto queimador em ferro fundido / Possibilidade de saída de escape superior, traseira ou lateral direita (tubagem interna não incluída) / Frente decorativa em vidro preto temperado / Porta com vidro efeito espelhado.

INCLUDING

Automatic modulation of combustion air, pellets supply and convection air / Ecoforest exclusive electronics / Control and programming by power or by room temperature with power modulation / Vacuum cleaning system / Multiple safety systems / Stainless steel burning pot / Aluminium finned heat exchanger with no daily cleaning required / Hearth with cast iron / Possibility of top, rear or right side exhaust outlet (internal flue pipes not included) / Front in black tempered glass / Fireplace door with mirror effect.

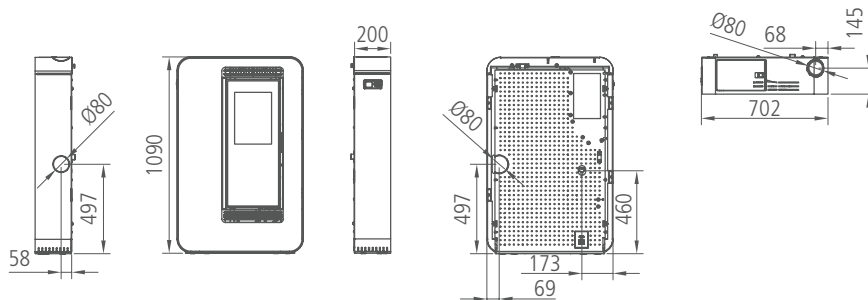

Vigo III



A+



WIFI
INTERNET
APP
INCL.



eco
SILENCE



Estanque
Airtight



CARACTERÍSTICAS TÉCNICAS

Potência: 9,5 kW
Rendimento: 91,8 %
Depósito: 16 kg
Consumo: 0,7 - 2,1 kg/h
Autonomia: 24 - 7 h
Peso: 92 kg
Diâmetro saída de gases: 80 mm
Diâmetro entrada de ar: 60 mm
EEI=124

TECHNICAL SPECIFICATIONS

Power: 9,5 kW
Performance: 91,8 %
Hopper: 16 kg
Consumption: 0,7 - 2,1 kg/h
Autonomy: 24 - 7 h
Weight: 92 kg
Gas outlet diameter: 80 mm
Gas inlet diameter: 60 mm
EEI=124

INCLUI

Controlo automático do fornecimento de ar de combustão, dos pellets e ar de convecção / Eletrónica exclusiva Ecoforest / Controlo e programação por potência ou por temperatura ambiente com modulação da potência / Policombustível (pellets, casca de amêndoa, caroço de azeitona) / Sistema de limpeza por vácuo / Múltiplos sistemas de segurança / Cesto queimador em ferro fundido / Intercâmbiador alhetado de alumínio sem necessidade de limpeza diária / Câmara de combustão reforçada em fundição e vermiculite / Frente e topo em vidro preto.

INCLUDING

Automatic modulation of combustion air, pellets supply and convection air / Ecoforest exclusive electronics / Control and programming by power or by room temperature with power modulation / Multifuel (pellets, almond shell, olive pit) / Vacuum cleaning system / Multiple safety systems / Cast iron burning pot / Aluminium finned heat exchanger with no daily cleaning required / Hearth with cast iron and vermiculite / Front and top in black tempered glass.

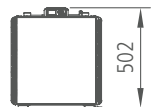
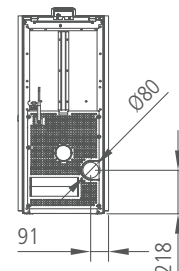
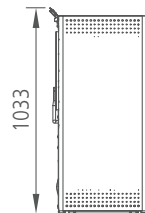
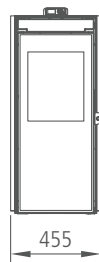

O modelo Keops é uma salamandra a pellets que oferece um design moderno em dois acabamentos, uma cor branca combinada com madeira natural de carvalho e outra em preto com madeira cor de noqueira. Oferece também um baixo nível de ruído e a possibilidade de uma instalação estanca, para além de todas as vantagens dos produtos Ecoforest.

The Keops model is a pellet stove that offers a modern design in two finishes: a mother-of-pearl colour combined with natural oak wood, and another in black with walnut wood. It also offers a low noise level and the possibility of a airtight installation, in addition to all the advantages of Ecoforest products.



Keops



Keops



A+



WiFi
INTERNET
APP
INCL.



eco
SILENCE



Estanque
Airtight



CARACTERÍSTICAS TÉCNICAS

Potência: 9,5 kW
Rendimento: 91,8 %
Depósito: 16 kg
Consumo: 0,7 - 2,1 kg/h
Autonomia: 24 - 7 h
Peso: 111 kg
Diâmetro saída de gases: 80 mm
Diâmetro entrada de ar: 60 mm
EEI=124

TECHNICAL SPECIFICATIONS

Power: 9,5 kW
Performance: 91,8 %
Hopper: 16 kg
Consumption: 0,7 - 2,1 kg/h
Autonomy: 24 - 7 h
Weight: 111 kg
Gas outlet diameter: 80 mm
Gas inlet diameter: 60 mm
EEI=124

INCLUI

Controlo e programação por potência ou por temperatura ambiente com modulação da potência / Eletrónica exclusiva Ecoforest / Controlo e programação por potência ou por temperatura ambiente com modulação da potência / Policombustível (pellets, casca de amêndoa, caroço de azeitona) / Sistema de limpeza por vácuo / Múltiplos sistemas de segurança / Cesto queimador em ferro fundido / Intercambiador alhetado de alumínio sem necessidade de limpeza diária / Câmara de combustão reforçada em fundição e vermiculite / Acabamento em madeira natural .

INCLUDING

Automatic modulation of combustion air, pellets supply and convection air / Ecoforest exclusive electronics / Control and programming by power or by room temperature with power modulation / Multifuel (pellets, almond shell, olive pit) / Vacuum cleaning system / Multiple safety systems / Cast iron burning pot / Aluminium finned heat exchanger with no daily cleaning required / Hearth with cast iron and vermiculite / Natural wood finish.

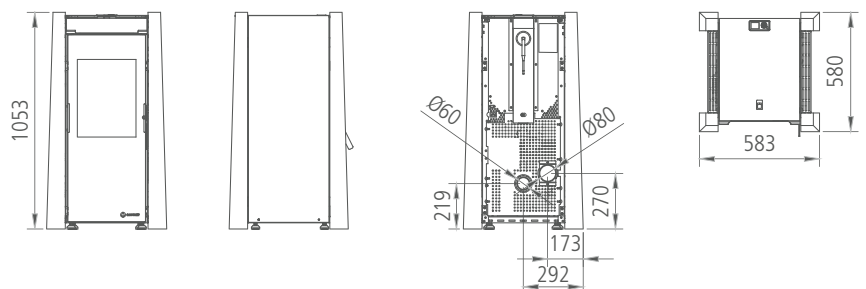

Marsella



A+



WiFi
INTERNET
APP
INCL.



eco
SILENCE



Estante
Airtight



CARACTERÍSTICAS TÉCNICAS

Potência: 9,9 kW
Rendimento: 92 %
Depósito: 15 kg
Consumo: 1 - 2,2 kg/h
Autonomia: 15 - 7 h
Peso: 115 kg
Diâmetro saída de gases: 80 mm
Diâmetro entrada de ar: 60 mm
EEI=126

TECHNICAL SPECIFICATIONS

Power: 9,9 kW
Performance: 92 %
Hopper: 15 kg
Consumption: 1 - 2,2 kg/h
Autonomy: 15 - 7 h
Weight: 115 kg
Gas outlet diameter: 80 mm
Gas inlet diameter: 60 mm
EEI=126

INCLUI

Controlo automático do fornecimento de ar de combustão, dos pellets e ar de convecção / Eletrónica exclusiva Ecoforest / Controlo e programação por potência ou por temperatura ambiente com modulação da potência / Sistema de limpeza por vácuo / Múltiplos sistemas de segurança / Cesto queimador em ferro fundido / Câmara de combustão reforçada em fundição / Intercâmbiador alhetado de alumínio sem necessidade de limpeza diária / Possibilidade de saída de escape traseira coaxial ou superior (tubagem interna não incluída).

INCLUDING

Automatic modulation of combustion air, pellets supply and convection air / Ecoforest exclusive electronics / Control and programming by power or by room temperature with power modulation / Vacuum cleaning system / Multiple safety systems / Cast iron burning pot / Hearth with cast iron / Aluminium finned heat exchanger with no daily cleaning required / Top or rear double-flow smoke outlet possibility (internal flue pipes not included).

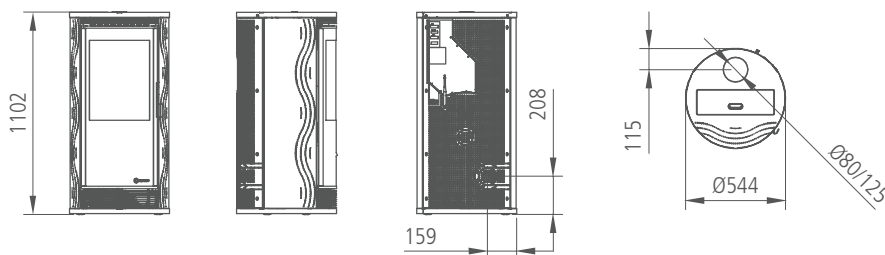

Praga



A+



WiFi
INTERNET
APP
INCL.



eco
SILENCE



CARACTERÍSTICAS TÉCNICAS

Potência: 12 kW
Rendimento: 91 %
Depósito: 28 kg
Consumo: 1,1 - 2,7 kg/h
Autonomia: 25 - 11 h
Peso: 155 kg
Diâmetro saída de gases: 80 mm
EEI=125

TECHNICAL SPECIFICATIONS

Power: 12 kW
Performance: 91 %
Hopper: 28 kg
Consumption: 1,1 - 2,7 kg/h
Autonomy: 25 - 11 h
Weight: 155 kg
Gas outlet diameter: 80 mm
EEI=125

INCLUI

Controlo automático do fornecimento de ar de combustão, dos pellets e ar de convecção / Eletrónica exclusiva Ecoforest / Controlo e programação por potência ou por temperatura ambiente com modulação da potência / Policombustível (pellets, casca de amêndoa, caroço de azeitona) / Sistema de limpeza por vácuo / Múltiplos sistemas de segurança / Cesto queimador em ferro fundido / Intercâmbiador alhetado de alumínio sem necessidade de limpeza diária / Câmara de combustão reforçada em vermiculite / Acabamento em madeira natural.

INCLUDING

Automatic modulation of combustion air, pellets supply and convection air / Ecoforest exclusive electronics / Control and programming by power or by room temperature with power modulation / Multifuel (pellets, almond shell, olive pit) / Vacuum cleaning system / Multiple safety systems / Cast iron burning pot / Aluminium finned heat exchanger with no daily cleaning required / Hearth with vermiculite / Natural wood finish.

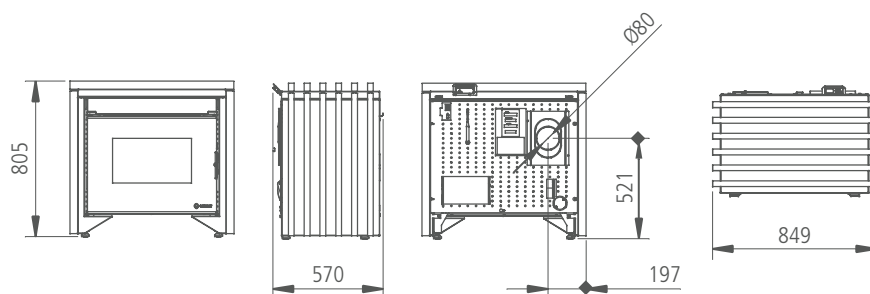

Tokio



A+



CARACTERÍSTICAS TÉCNICAS

Potência: 12 kW
Rendimento: 91 %
Depósito: 30 kg
Consumo: 1,1 - 2,7 kg/h
Autonomia: 27 - 11 h
Peso: 146 kg
Diâmetro saída de gases: 80 mm
EEI=125

TECHNICAL SPECIFICATIONS

Power: 12 kW
Performance: 91 %
Hopper: 30 kg
Consumption: 1,1 - 2,7 kg/h
Autonomy: 27 - 11 h
Weight: 146 kg
Gas outlet diameter: 80 mm
EEI=125

INCLUI

Controlo automático do fornecimento de ar de combustão, dos pellets e ar de convecção
Eletrónica exclusiva Ecoforest / Controlo e programação por potência ou por temperatura ambiente com modulação da potência / Policombustível (pellets, casca de amêndoa, caroço de azeitona) / Sistema de limpeza por vácuo / Múltiplos sistemas de segurança / Cesto queimador em ferro fundido / Intercambiador alhetado de alumínio sem necessidade de limpeza diária / Câmara de combustão reforçada em vermiculite / Possibilidade de saída de gases traseira ou superior (tubagem interna não incluída).

INCLUDING

Automatic modulation of combustion air, pellets supply and convection air / Ecoforest exclusive electronics / Control and programming by power or by room temperature with power modulation / Multifuel (pellets, almond shell, olive pit) / Vacuum cleaning system / Multiple safety systems / Cast iron burning pot / Aluminium finned heat exchanger with no daily cleaning required / Hearth with vermiculite / Top or rear smoke outlet possibility (internal flue pipes not included).

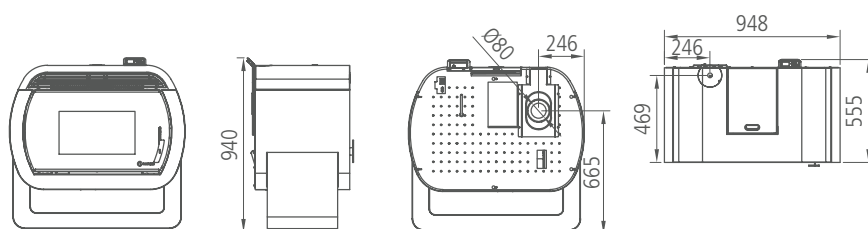

Eco I



A+



WIFI
INTERNET
APP
INCL.



eco
SILENCE



CARACTERÍSTICAS TÉCNICAS

Potência: 13,5 kW
Rendimento: 85 %
Depósito: 30 kg
Consumo: 1,5 - 3,2 kg/h
Autonomia: 20 - 9 h
Peso: 105 kg
Diâmetro saída de gases: 80 mm
EEI=120

TECHNICAL SPECIFICATIONS

Power: 13,5 kW
Performance: 85 %
Hopper: 30 kg
Consumption: 1,5 - 3,2 kg/h
Autonomy: 20 - 9 h
Weight: 105 kg
Gas outlet diameter: 80 mm
EEI=120

INCLUI

Controlo automático do fornecimento de ar de combustão, dos pellets e ar de convecção / Eletrónica exclusiva Ecoforest / Controlo e programação por potência ou por temperatura ambiente com modulação da potência / Policombustível (pellets, casca de amêndoa, caroço de azeitona) / Sistema de limpeza por vácuo / Múltiplos sistemas de segurança / Cesto queimador em aço inoxidável / Intercâmbiador tubular fabricado em aço inoxidável / Câmara de combustão reforçada em fundição.

INCLUDING

Automatic modulation of combustion air, pellets supply and convection air / Ecoforest exclusive electronics / Control and programming by power or by room temperature with power modulation / Multifuel (pellets, almond shell, olive pit) / Vacuum cleaning system / Multiple safety systems / Stainless steel burning pot / Stainless steel tube heat exchanger / Hearth with cast iron.

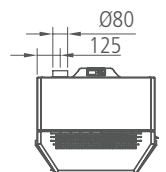
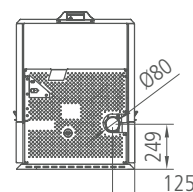
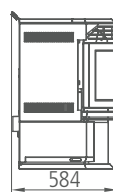
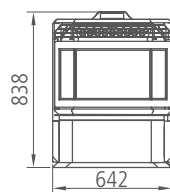

Atenas



O nosso modelo Atenas é a solução ideal para aqueles que procuram uma salamandra a pellets de design e com grande potência

Our Atenas model is the ideal solution for those who are looking for a high-power pellet stove with a compelling design.





Atenas

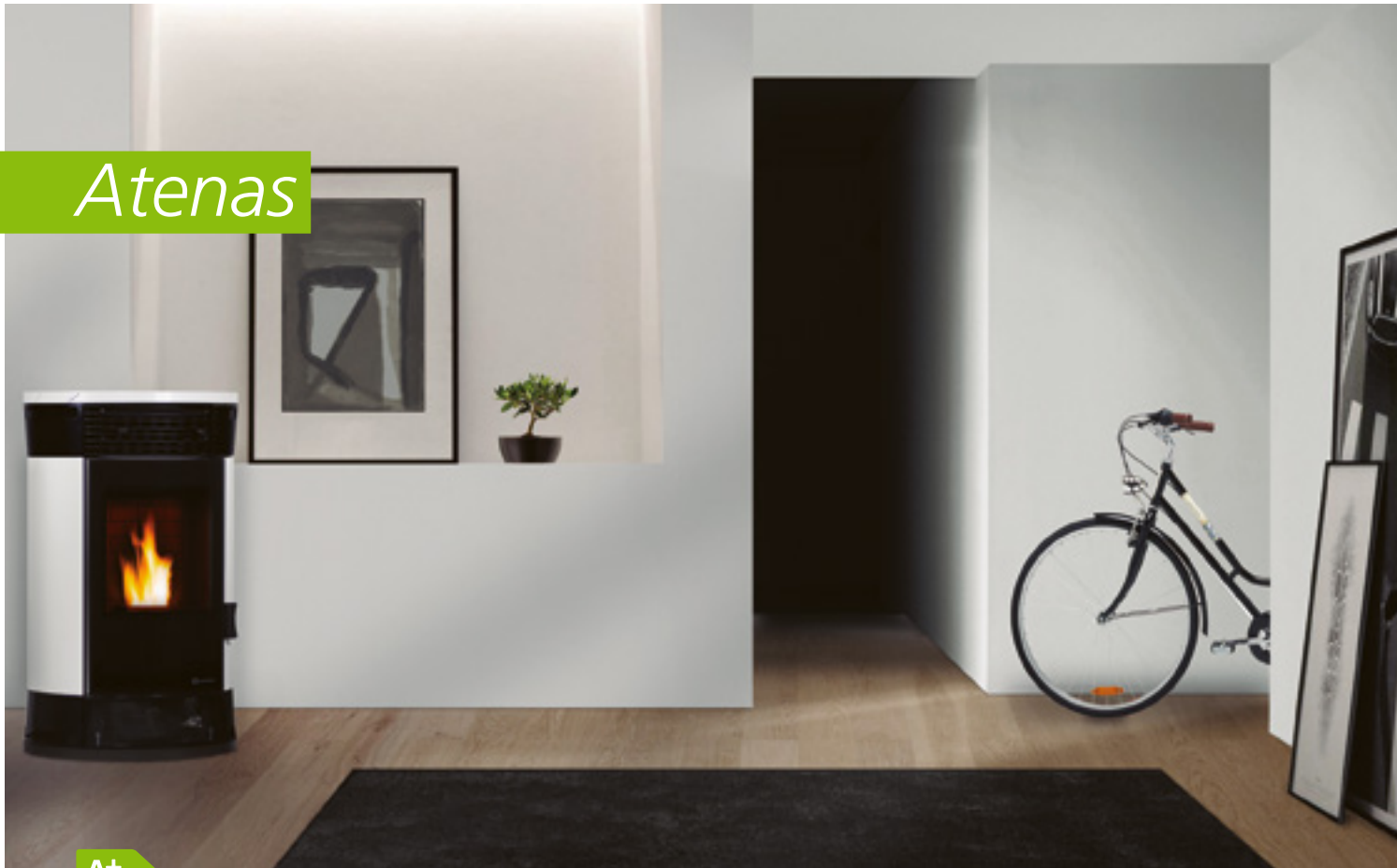

A+



WIFI
INTERNET
APP
INCL.



eco
SILENCE



CARACTERÍSTICAS TÉCNICAS

Potência: 14 kW
Rendimento: 89,4 %
Depósito: 25 kg
Consumo: 1,2 - 3,3 kg/h
Autonomia: 21 - 8 h
Peso: 139 kg
Diâmetro saída de gases: 80 mm
EEI=121

TECHNICAL SPECIFICATIONS

Power: 14 kW
Performance: 89,4 %
Hopper: 25 kg
Consumption: 1,2 - 3,3 kg/h
Autonomy: 21 - 8 h
Weight: 139 kg
Gas outlet diameter: 80 mm
EEI=121

INCLUI

Controlo automático do fornecimento de ar de combustão, dos pellets e ar de convecção / Eletrónica exclusiva Ecoforest / Controlo e programação por potência ou por temperatura ambiente com modulação da potência / Policombustível (pellets, casca de amêndoa, caroço de azeitona) / Sistema de limpeza por vácuo / Múltiplos sistemas de segurança / Cesto queimador em ferro fundido / Intercambiador tubular fabricado em aço inoxidável / Câmara de combustão reforçada em fundição.

INCLUDING

Automatic modulation of combustion air, pellets supply and convection air / Ecoforest exclusive electronics / Control and programming by power or by room temperature with power modulation / Multifuel (pellets, almond shell, olive pit) / Vacuum cleaning system / Multiple safety systems / Cast iron burning pot / Stainless steel tube heat exchanger / Hearth with cast iron.

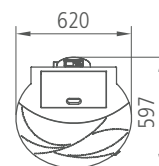
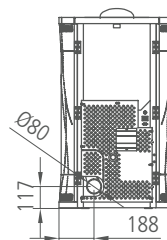
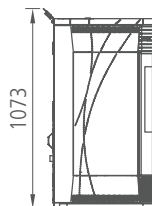
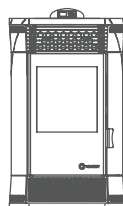

Nature



A+



Painel solar opcional
Optional solar panel
68903



CARACTERÍSTICAS TÉCNICAS

Potência: 7,5 kW
Rendimento: 85 %
Depósito: 15 kg
Consumo max.: 1,8 kg/h
Autonomia: 9 h
Peso: 170 kg
Diâmetro saída de gases: 150 mm
EEI=121

TECHNICAL SPECIFICATIONS

Power: 7,5 kW
Performance: 85 %
Hopper: 15 kg
Consumption max.: 1,8 kg/h
Autonomy: 9 h
Weight: 170 kg
Gas outlet diameter: 150 mm
EEI=121

INCLUI

Sem alimentação elétrica da rede / Sem ventiladores / Chaminé com tiragem natural / Silenciosa / Câmara de combustão reforçada em vermiculite / Cesto em aço inoxidável / Radiação de calor por convecção natural / Grelha de proteção da saída de gases.

INCLUDING

No connection to the main power / Without fans / With natural draught / Silent / Hearth with vermiculite / Stainless steel burning pot / Heat radiation by natural convection / Gas outlet protection grid.

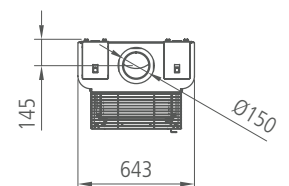
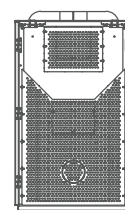
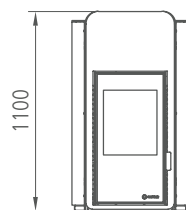

» info p37

Cordoba Glass



Faça sobressair uma das paredes da sua casa com o nosso recuperador a pellets Cordoba Glass.

Highlight one of the walls in your house with our Cordoba Glass pellet stove.





Eco Mini Insert

Insert



A+



WIFI
INTERNET
APP
INCL.



eco
SILENCE



Estanque
Airtight



CARACTERÍSTICAS TÉCNICAS

Potência: 8 kW
Rendimento: 95 %
Depósito: 15 kg
Consumo: 0,8 - 1,8 kg/h
Autonomia: 18 - 8 h
Peso: 77 kg
Diâmetro saída de gases: 80 mm
Diâmetro entrada de ar: 60 mm
EEI=124

TECHNICAL SPECIFICATIONS

Power: 8 kW
Performance: 95 %
Hopper: 15 kg
Consumption: 0,8 - 1,8 kg/h
Autonomy: 18 - 8 h
Weight: 77 kg
Gas outlet diameter: 80 mm
Gas inlet diameter: 60 mm
EEI=124

INCLUI

Controlo automático do fornecimento de ar de combustão, dos pellets e ar de convecção / Eletrónica exclusiva Ecoforest / Controlo e programação por potência ou por temperatura ambiente com modulação da potência / Policombustível (pellets, casca de amêndoa, caroço de azeitona) / Sistema de limpeza por vácuo / Múltiplos sistemas de segurança / Intercâmbiador alhetado de alumínio sem necessidade de limpeza diária / Cesto queimador em ferro fundido / Câmara de combustão reforçada em fundição / Carregamento pela parte superior ou através da opcional porta de carga.

INCLUDING

Automatic modulation of combustion air, pellets supply and convection air / Ecoforest exclusive electronics / Control and programming by power or by room temperature with power modulation / Multifuel (pellets, almond shell, olive pit) / Vacuum cleaning system / Multiple safety systems / Aluminium finned heat exchanger with no daily cleaning required / Cast iron burning pot / Hearth with cast iron / Top loading or optional loading trapdoor.

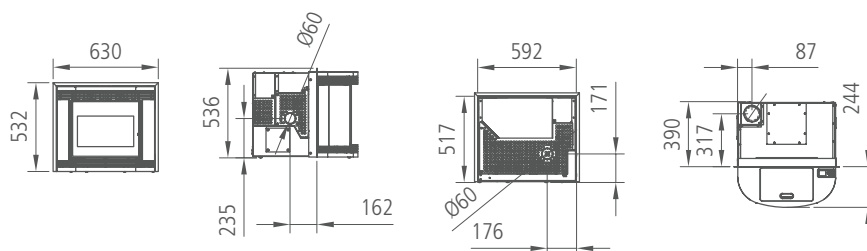

Cordoba Glass

Insert



A+



WIFI
INTERNET
APP
INCL.



eco
SILENCE



CARACTERÍSTICAS TÉCNICAS

Potência: 12 kW
Rendimento: 91 %
Depósito: 25 kg
Consumo: 1,1 - 2,7 kg/h
Autonomia: 23 - 9 h
Peso: 138,5 kg
Diâmetro saída de gases: 80 mm
EEI=125

TECHNICAL SPECIFICATIONS

Power: 12 kW
Performance: 91 %
Hopper: 25 kg
Consumption: 1,1 - 2,7 kg/h
Autonomy: 23 - 9 h
Weight: 138,5 kg
Gas outlet diameter: 80 mm
EEI=125

INCLUI

Controlo automático do fornecimento de ar de combustão, dos pellets e ar de convecção / Eletrónica exclusiva Ecoforest / Controlo e programação por potência ou por temperatura ambiente com modulação da potência / Policombustível (pellets, casca de amêndoa, caroço de azeitona) / Sistema de limpeza por vácuo / Múltiplos sistemas de segurança / Cesto queimador em ferro fundido / Intercambiador alhetado de alumínio sem necessidade de limpeza diária / Câmara de combustão reforçada em vermiculite / Tabuleiro de combustível de grande capacidade / Guias de extracção para manutenção / Estrutura para montagem regulável em altura / Frontal decorativo em vidro temperado preto.

INCLUDING

Automatic modulation of combustion air, pellets supply and convection air / Ecoforest exclusive electronics / Control and programming by power or by room temperature with power modulation / Multifuel (pellets, almond shell, olive pit) / Vacuum cleaning system / Multiple safety systems / Cast iron burning pot / Aluminium finned heat exchanger with no daily cleaning required / Hearth with vermiculite / Large capacity fuel tray / Extraction guides for maintenance / Height-adjustable mounting structure / Front black tempered glass.

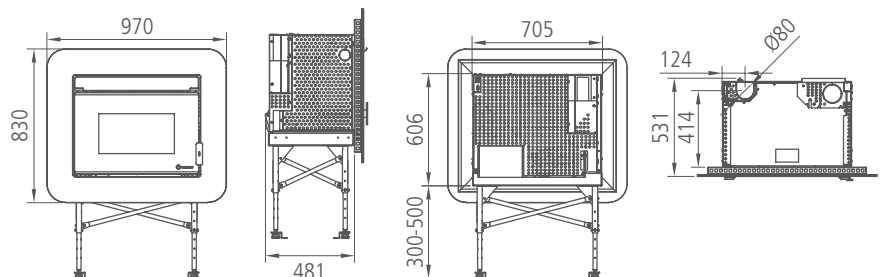

Cordoba

Insert



A+



WIFI
INTERNET
APP
INCL.



eco
SILENCE



CARACTERÍSTICAS TÉCNICAS

Potência: 12 kW
Rendimento: 91 %
Depósito: 25 kg
Consumo: 1,1 - 2,7 kg/h
Autonomia: 23 - 9 h
Peso: 119,5 kg
Diâmetro saída de gases: 80 mm
EEI=125

TECHNICAL SPECIFICATIONS

Power: 12 kW
Performance: 91 %
Hopper: 25 kg
Consumption: 1,1 - 2,7 kg/h
Autonomy: 23 - 9 h
Weight: 119,5 kg
Gas outlet diameter: 80 mm
EEI=125

INCLUI

Controlo automático do fornecimento de ar de combustão, dos pellets e ar de convecção / Eletrónica exclusiva Ecoforest / Controlo e programação por potência ou por temperatura ambiente com modulação da potência / Policombustível (pellets, casca de amêndoa, caroço de azeitona) / Sistema de limpeza por vácuo / Múltiplos sistemas de segurança / Cesto queimador em ferro fundido / Intercambiador alheteado de alumínio sem necessidade de limpeza diária / Câmara de combustão reforçada em vermiculite / Tabuleiro de combustível de grande capacidade / Guias de extração do recuperador para facilitar a manutenção.

INCLUDING

Automatic modulation of combustion air, pellets supply and convection air / Ecoforest exclusive electronics / Control and programming by power or by room temperature with power modulation / Multifuel (pellets, almond shell, olive pit) / Vacuum cleaning system / Multiple safety systems / Cast iron burning pot / Aluminium finned heat exchanger with no daily cleaning required / Hearth with vermiculite / Large capacity fuel tray / Extraction guides for maintenance.

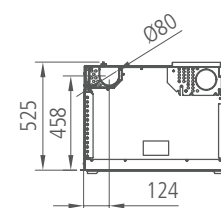
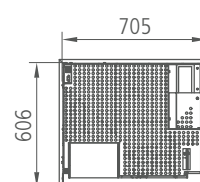
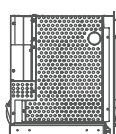
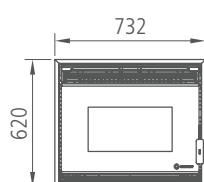

Eco I Insert

Insert



A+



WIFI
INTERNET
APP
INCL.



eco
SILENCE



CARACTERÍSTICAS TÉCNICAS

Potência: 13,5 kW
Rendimento: 85 %
Depósito: 20 kg
Consumo: 1,5 - 3,2 kg/h
Autonomia: 14 - 6 h
Peso: 105 kg
Diâmetro saída de gases: 80 mm
EEI=120

TECHNICAL SPECIFICATIONS

Power: 13,5 kW
Performance: 85 %
Hopper: 20 kg
Consumption: 1,5 - 3,2 kg/h
Autonomy: 14 - 6 h
Weight: 105 kg
Gas outlet diameter: 80 mm
EEI=120

INCLUI

Controlo automático do fornecimento de ar de combustão, dos pellets e ar de convecção / Eletrónica exclusiva Ecoforest / Controlo e programação por potência ou por temperatura ambiente com modulação da potência / Policombustível (pellets, casca de amêndoa, caroço de azeitona) / Sistema de limpeza por vácuo / Múltiplos sistemas de segurança / Cesto queimador em aço inoxidável / Intercâmbiador tubular fabricado em aço inoxidável / Câmara de combustão reforçada em fundição.

INCLUDING

Automatic modulation of combustion air, pellets supply and convection air / Ecoforest exclusive electronics / Control and programming by power or by room temperature with power modulation / Multifuel (pellets, almond shell, olive pit) / Vacuum cleaning system / Multiple safety systems / Stainless steel burning pot / Stainless steel tube heat exchanger / Hearth with cast iron.

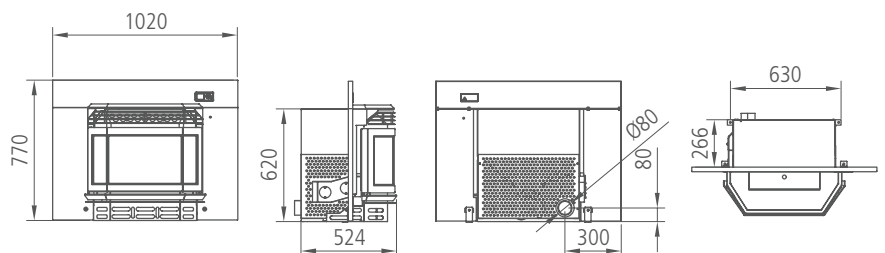

Ar canalizável

Ducted Air



Os nossos modelos canalizáveis permitem que o calor seja distribuído em casa através de uma série de condutas. Esta série de produtos é adequada para todos aqueles utilizadores que procuram um sistema de aquecimento limpo, natural e muito eficaz para aquecer as diferentes áreas da sua casa.

Our ducted stoves allow heat to be distributed in the home through a series of ducts. These products are suitable for users who are looking for a clean, natural and very effective heating system for different rooms in a house.

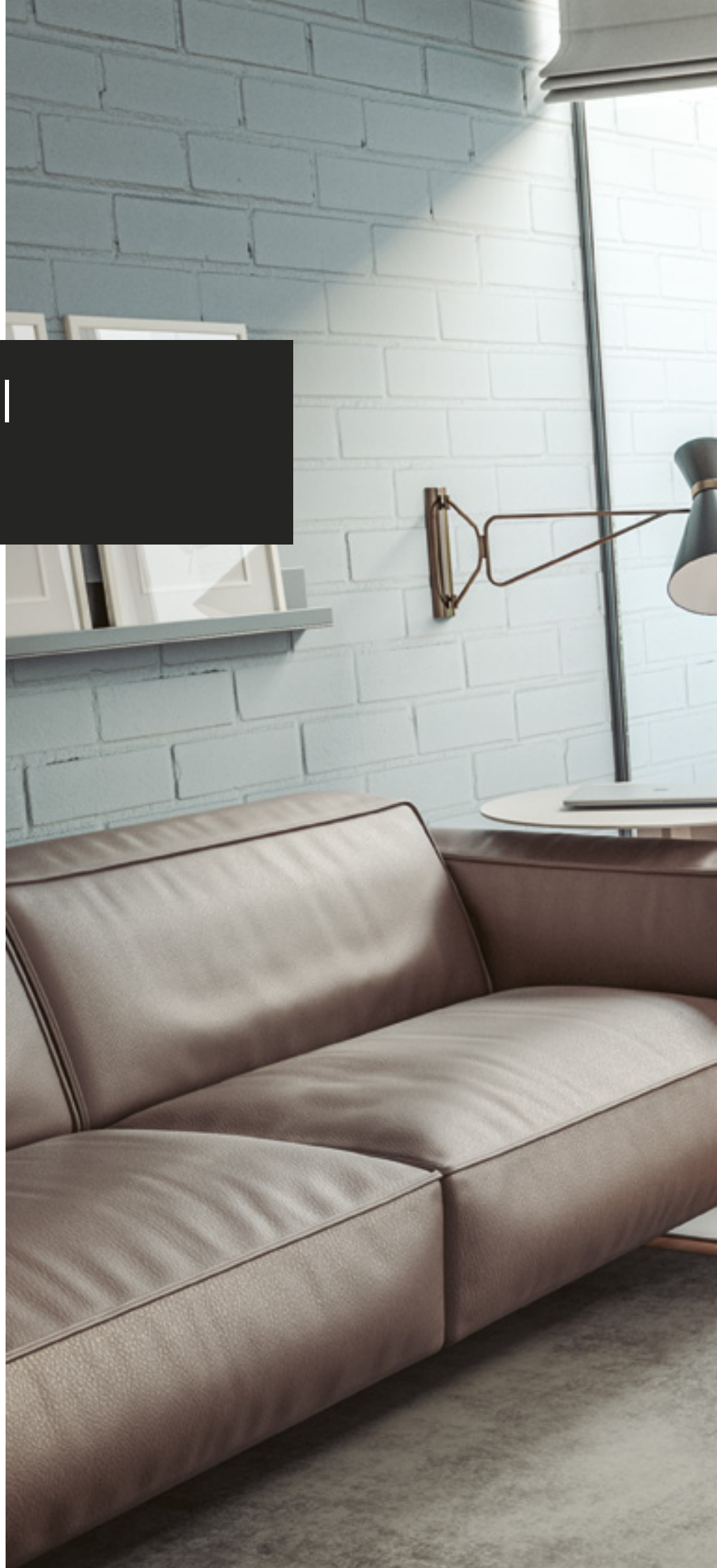



Esquema de ar canalizável

Ducted air scheme

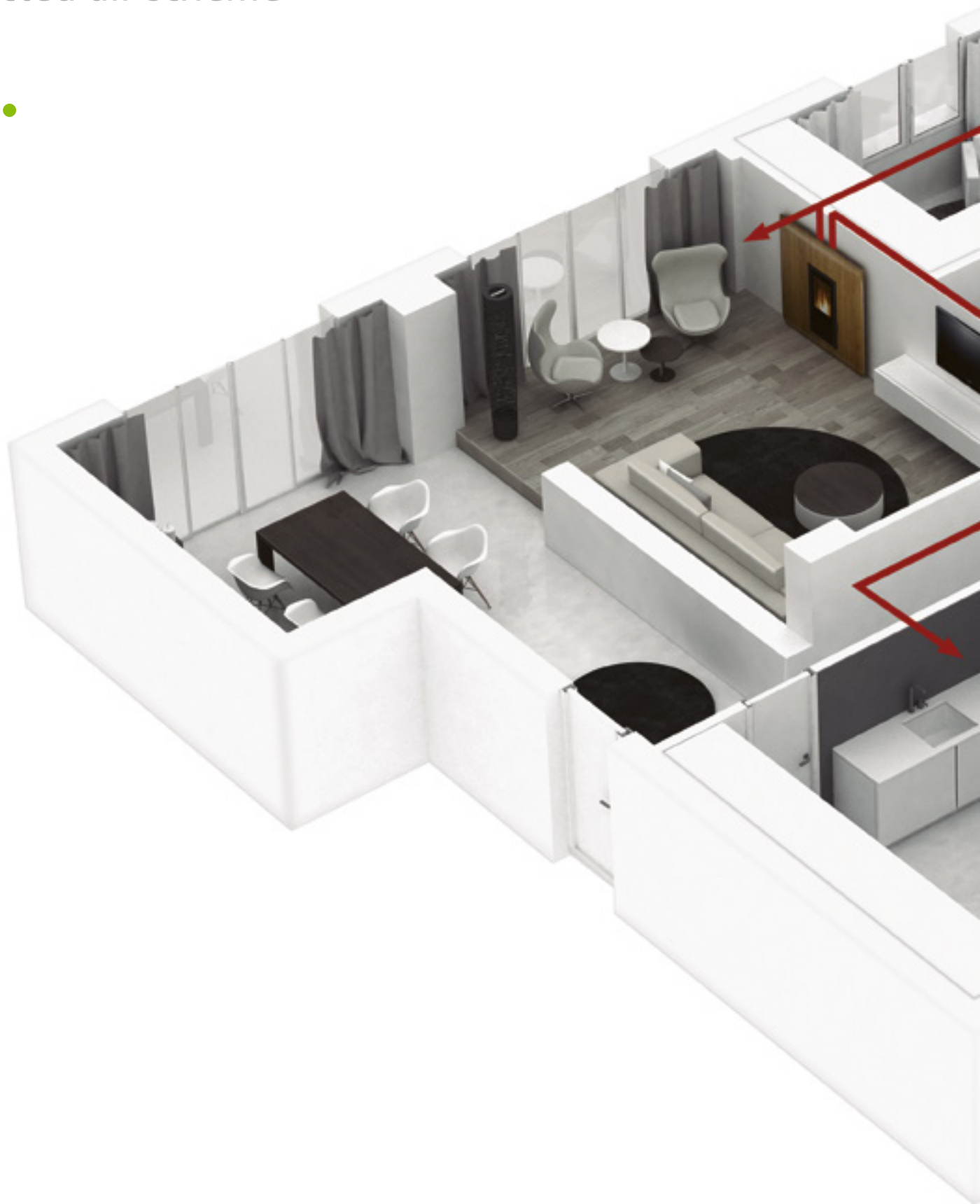



Ventilador para distribuição de ar quente
Hot air distribution ventilator

» info p48

Dubai



A nossa salamandra de pellets Dubai tornará a sua sala de estar única. A combinação da porta com um vidro de efeito espelho faz deste modelo uma peça decorativa.

Our Dubai pellet stove will turn your living room into a unique place. The combination of a door with a mirror-effect glass makes this model a design item.





Bolonia



A+



CARACTERÍSTICAS TÉCNICAS

Potência: 10 kW
 Rendimento: 92,9 %
 Depósito: 20 kg
 Consumo: 1 - 2,2 kg/h
 Autonomia: 19 - 9 h
 Peso: 143 kg
 Diâmetro saída de gases: 80 mm
 Diâmetro entrada de ar: 60 mm
 Diâmetro saída canalização de ar: 1x100 mm
 EEI=127

TECHNICAL SPECIFICATIONS

Power: 10 kW
 Performance: 92,9 %
 Hopper: 20 kg
 Consumption: 1 - 2,2 kg/h
 Autonomy: 19 - 9 h
 Weight: 143 kg
 Gas outlet diameter: 80 mm
 Gas inlet diameter: 60 mm
 Ducted air outlet diameter: 1x100 mm
 EEI=127

INCLUSI

Controlo automático do fornecimento de ar de combustão, dos pellets e ar de convecção / Eletrónica exclusiva Ecoforest / Controlo e programação por potência ou por temperatura ambiente com modulação da potência / Policombustível (pellets, casca de amêndoa, caroço de azeitona) / Sistema de limpeza por vácuo / Múltiplos sistemas de segurança / Cesto queimador em aço inoxidável / Intercâmbiador alheteado de alumínio sem necessidade de limpeza diária / Câmara de combustão reforçada em fundição / Uma saída de ar canalizável, traseira ou superior, long. max. 7 m / Saída de ar direta (frontal e/ou canalizável traseira ou superior) / Possibilidade de saída gases superior, traseira ou lateral (tubo interior não incluído) / Frontal decorativo em vidro preto temperado.

INCLUDING

Automatic modulation of combustion air, pellets supply and convection air / Ecoforest exclusive electronics / Control and programming by power or by room temperature with power modulation / Multifuel (pellets, almond shell, olive pit) / Vacuum cleaning system / Multiple safety systems / Stainless steel burning pot / Aluminium finned heat exchanger with no daily cleaning required / Hearth with cast iron / A rear or top ducted air outlet, maximum length 7 metres / Adjustable (front and/or rear ductable) air outlet / Possibility of superior, back or lateral gas outlet (internal flue pipes not included) / Front in black tempered glass.

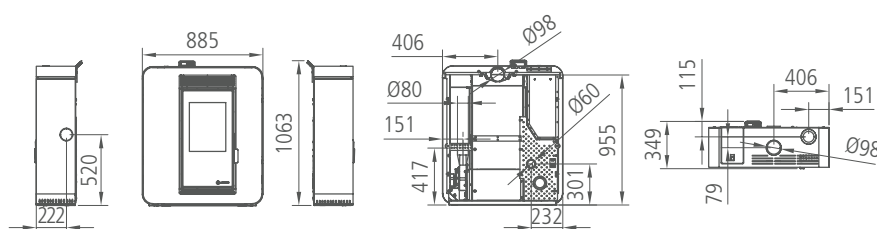

Ibiza



A+



WIFI
INTERNET
APP
INCL.



eco
SILENCE



CARACTERÍSTICAS TÉCNICAS

Potência: 11 kW
Rendimento: 91,2 %
Depósito: 29 kg
Consumo: 1,2 - 2,5 kg/h
Autonomia: 25 - 11 h
Peso: 152 kg
Diâmetro saída de gases: 100 mm
Diâmetro saída canalização de ar:
2x120 mm
EEI=122

TECHNICAL SPECIFICATIONS

Power: 11 kW
Performance: 91,2 %
Hopper: 29 kg
Consumption: 1,2 - 2,5 kg/h
Autonomy: 25 - 11 h
Weight: 152 kg
Gas outlet diameter: 100 mm
Ducted air outlet diameter:
2x120 mm
EEI=122

INCLUI

Controlo automático do fornecimento de ar de combustão, dos pellets e ar de convecção / Eletrónica exclusiva Ecoforest / Controlo e programação por potência ou por temperatura ambiente com modulação da potência / Sistema de limpeza por vácuo / Múltiplos sistemas de segurança / Cesto queimador em aço inoxidável / Intercâmbiador alheteadado de alumínio sem necessidade de limpeza diária / Câmara de combustão reforçada em fundição e vermiculite / Duas saídas de ar canalizável, long. max. 7 m / Configuração de canalização com 3 posições (traseira e/ou superior) / Saída de gases traseira ou lateral direito opcional / Frente decorativa em vidro preto temperado.

INCLUDING

Automatic modulation of combustion air, pellets supply and convection air / Ecoforest exclusive electronics / Control and programming by power or by room temperature with power modulation / Vacuum cleaning system / Multiple safety systems / Stainless steel burning pot / Aluminium finned heat exchanger with no daily cleaning required / Hearth with cast iron and vermiculite / Two ducted air outlets, maximum length 7 metres / Duct connection: three options, rear and/or top / Rear gas outlet or optional right lateral gas outlet / Front black tempered glass.

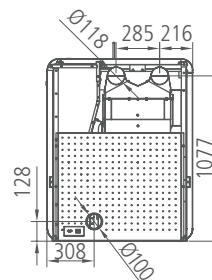
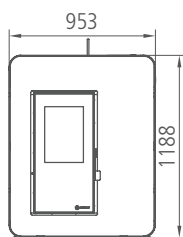

Dubai



A+



WIFI
INTERNET
APP
INCL.



eco
SILENCE



CARACTERÍSTICAS TÉCNICAS

Potência: 11,9 kW
Rendimento: 90 %
Depósito: 15 kg
Consumo: 0,8 - 2,7 kg/h
Autonomia: 19 - 6 h
Peso: 130 kg
Diâmetro saída de gases: 80 mm
Diâmetro saída canalização de ar:
1x100 mm
EEI=125

TECHNICAL SPECIFICATIONS

Power: 11,9 kW
Performance: 90 %
Hopper: 15 kg
Consumption: 0,8 - 2,7 kg/h
Autonomy: 19 - 6 h
Weight: 130 kg
Gas outlet diameter: 80 mm
Ducted air outlet diameter:
1x100 mm
EEI=125

INCLUI

Controlo automático do fornecimento de ar de combustão, dos pellets e ar de convecção / Eletrónica exclusiva Ecoforest / Controlo e programação por potência ou por temperatura ambiente com modulação da potência / Policombustível (pellets, casca de amêndoa, caroço de azeitona) / Sistema de limpeza por vácuo / Múltiplos sistemas de segurança / Cesto queimador em ferro fundido / Intercâmbiador alhetado de alumínio sem necessidade de limpeza diária / Câmara de combustão reforçada em vermiculite / Saída de ar frontal / Saída de ar canalizável traseira, long. max. 7m / Porta com vidro efeito espelhado.

INCLUDING

Automatic modulation of combustion air, pellets supply and convection air / Ecoforest exclusive electronics / Control and programming by power or by room temperature with power modulation / Multifuel (pellets, almond shell, olive pit) / Vacuum cleaning system / Multiple safety systems / Cast iron burning pot / Aluminium finned heat exchanger with no daily cleaning required / Hearth with vermiculite / A front air outlet / A back ducted air outlet, maximum length 7 m / Fireplace door with mirror effect.

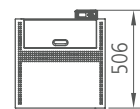
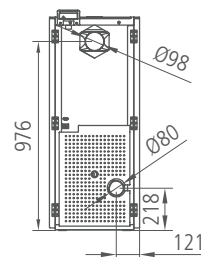
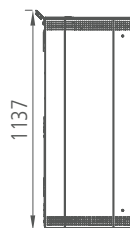
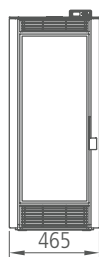

Roma



A+



WIFI
INTERNET
APP
INCL.



eco
SILENCE



CARACTERÍSTICAS TÉCNICAS

Potência: 11,9 kW
Rendimento: 90 %
Depósito: 15 kg
Consumo: 0,8 - 2,7 kg/h
Autonomia: 19 - 6 h
Peso: 130 kg
Diâmetro saída de gases: 80 mm
Diâmetro saída canalização de ar:
1x100 mm
EEI=125

TECHNICAL SPECIFICATIONS

Power: 11,9 kW
Performance: 90 %
Hopper: 15 kg
Consumption: 0,8 - 2,7 kg/h
Autonomy: 19 - 6 h
Weight: 130 kg
Gas outlet diameter: 80 mm
Ducted air outlet diameter:
1x100 mm
EEI=125

INCLUI

Controlo automático do fornecimento de ar de combustão, dos pellets e ar de convecção / Eletrónica exclusiva Ecoforest / Controlo e programação por potência ou por temperatura ambiente com modulação da potência / Policombustível (pellets, casca de amêndoa, caroço de azeitona) / Vacuum cleaning system / Múltiplos sistemas de segurança / Cesto queimador em ferro fundido / Intercambiador alhetado de alumínio sem necessidade de limpeza diária / Câmara de combustão reforçada em vermiculite / Saída de ar frontal / Uma saída de ar canalizável traseira, long. max. 7 m / Acabamento aço inoxidável cromado (efeito espelho) / Porta com vidro efeito espelhado.

INCLUDING

Automatic modulation of combustion air, pellets supply and convection air / Ecoforest exclusive electronics / Control and programming by power or by room temperature with power modulation / Multifuel (pellets, almond shell, olive pit) / Vacuum cleaning system / Multiple safety systems / Cast iron burning pot / Aluminium finned heat exchanger with no daily cleaning required / Hearth with vermiculite / A front air outlet / A back ducted air outlet, maximum length 7 m / Stainless steel finish (mirror effect) / Fireplace door with mirror effect.

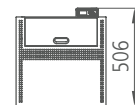
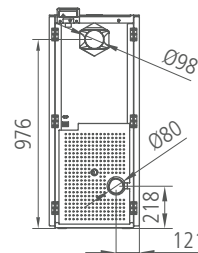
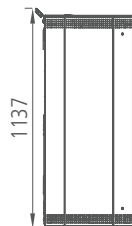

» info p46

Bolonia



A salamandra a pellets ideal para qualquer casa. Pode enviar o calor para toda a sua casa de uma forma económica e fácil. Com saída de ar frontal e saída de ar canalizado para aquecer diferentes divisões da casa.

The ideal pellet stove for any home. You can convey the heat throughout your home in a cost-efficient and easy way. With a front air outlet and a ductable air outlet to heat different rooms in the house.



Está à procura de uma salamandra de design para a sua casa? Com a nossa salamandra a pellets modelo Venecia pode aquecer a sua casa e decorá-la ao mesmo tempo. A Venecia tem um acabamento em madeira de bambu, um design unico que não o decepcionará.

Are you looking for a high-end design stove for your home? With our Venecia pellet stove you can heat your home and decorate it. Its bamboo finish will not disappoint you.



Venecia Bambú

Venecia Bambú



A+



WIFI
INTERNET
APP
INCL.



eco
SILENCE



CARACTERÍSTICAS TÉCNICAS

Potência: 14 kW
Rendimento: 89,6 %
Depósito: 54 kg
Consumo: 1,4 - 3,2 kg/h
Autonomia: 38 - 17 h
Peso: 182 kg
Diâmetro saída de gases: 100 mm
Diâmetro saída canalização de ar:
2x120 mm
EEI=122

TECHNICAL SPECIFICATIONS

Power: 14 kW
Performance: 89,6 %
Hopper: 54 kg
Consumption: 1,4 - 3,2 kg/h
Autonomy: 38 - 17 h
Weight: 182 kg
Gas outlet diameter: 100 mm
Ducted air outlet diameter:
2x120 mm
EEI=122

INCLUI

Controlo automático do fornecimento de ar de combustão, dos pellets e ar de convecção / Eletrónica exclusiva Ecoforest / Controlo e programação por potência ou por temperatura ambiente com modulação da potência / Sistema de limpeza por vácuo / Múltiplos sistemas de segurança / Intercambiador alhetado de alumínio sem necessidade de limpeza diária / Cesto queimador em ferro fundido / Câmara de combustão reforçada em fundição / Duas saídas de ar canalizável, long. max. 7 m / Configuração opcional de canalização com 3 posições (traseira e/ou superior) / Frontal decorativo em madeira de bambu.

INCLUDING

Automatic modulation of combustion air, pellets supply and convection air / Ecoforest exclusive electronics / Control and programming by power or by room temperature with power modulation / Vacuum cleaning system / Multiple safety systems / Aluminium finned heat exchanger with no daily cleaning required / Cast iron burning pot / Hearth with cast iron / Two ducted air outlets, maximum length 7 metres / Duct connection: three options, rear and/or top / Decorative front in bamboo wood.

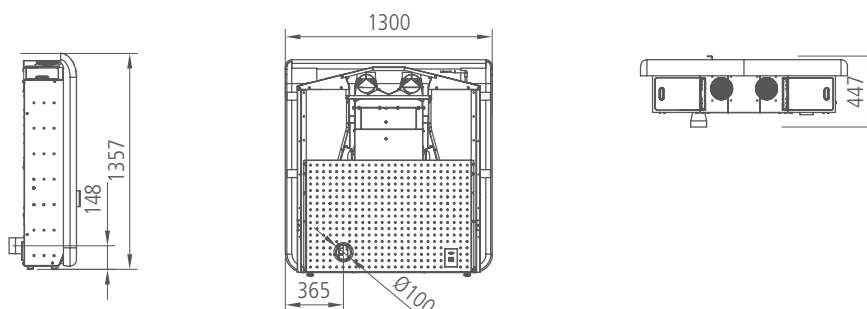

Kiev



A+



CARACTERÍSTICAS TÉCNICAS

Potência: 16 kW
Rendimento: 92 %
Depósito: 45 kg
Consumo: 1,6 - 3,6 kg/h
Autonomia: 28 - 13 h
Peso: 170 kg
Diâmetro saída de gases: 100 mm
Diâmetro saída canalização de ar:
2x120 mm
EEI=125

TECHNICAL SPECIFICATIONS

Power: 16 kW
Performance: 92 %
Hopper: 45 kg
Consumption: 1,6 - 3,6 kg/h
Autonomy: 28 - 13 h
Weight: 170 kg
Gas outlet diameter: 100 mm
Ducted air outlet diameter:
2x120 mm
EEI=125

INCLUI

Controlo automático do fornecimento de ar de combustão, dos pellets e ar de convecção / Eletrónica exclusiva Ecoforest / Controlo e programação por potência ou por temperatura ambiente com modulação da potência / Policombustível (pellets, casca de amêndoa, caroço de azeitona) / Sistema de limpeza por vácuo / Múltiplos sistemas de segurança / Cesto queimador em aço inoxidável / Intercâmbiador alhetado de alumínio sem necessidade de limpeza diária / Câmara de combustão reforçada em vermiculite / Duas saídas de ar canalizável, long. max. 7 m / Saída de ar frontal, traseira canalizável ou intermédia em cada saída / Rodas para manuseamento.

INCLUDING

Automatic modulation of combustion air, pellets supply and convection air / Ecoforest exclusive electronics / Control and programming by power or by room temperature with power modulation / Multifuel (pellets, almond shell, olive pit) / Vacuum cleaning system / Multiple safety systems / Stainless steel burning pot / Aluminium finned heat exchanger with no daily cleaning required / Hearth with vermiculite / Two ducted air outlets, maximum length 7 metres / Front, rear or intermediate ductable air outlet at each outlet / Wheels for handling.

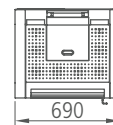
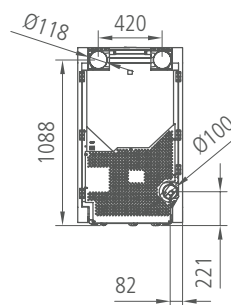
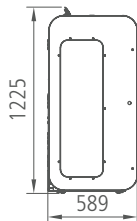
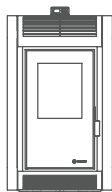

Oslo



A+



WIFI
INTERNET
APP
INCL.



eco
SILENCE



CARACTERÍSTICAS TÉCNICAS

Potência: 30 kW
Rendimento: 92,3 %
Depósito: 90 kg
Consumo: 2,9 - 6,8 kg/h
Autonomia: 31 - 13 h
Peso: 270 kg
Diâmetro saída de gases: 100 mm
Diâmetro saída canalização de ar:
3x150 mm
EEI=124

TECHNICAL SPECIFICATIONS

Power: 30 kW
Performance: 92,3 %
Hopper: 90 kg
Consumption: 2,9 - 6,8 kg/h
Autonomy: 31 - 13 h
Weight: 270 kg
Gas outlet diameter: 100 mm
Ducted air outlet diameter:
3x150 mm
EEI=124

INCLUI

Controlo automático do fornecimento de ar de combustão, dos pellets e ar de convecção / Eletrónica exclusiva Ecoforest / Controlo e programação por potência ou por temperatura ambiente com modulação da potência / Policombustível (pellets, casca de amêndoa, caroço de azeitona) / Sistema de limpeza por vácuo / Múltiplos sistemas de segurança / Cesto queimador em aço inoxidável / Intercambiador alheteado de alumínio sem necessidade de limpeza diária / Câmara de combustão reforçada em vermiculite / Três saídas de ar canalizáveis, long. max. 14 m / Rodas para manuseamento.

INCLUDING

Automatic modulation of combustion air, pellets supply and convection air / Ecoforest exclusive electronics / Control and programming by power or by room temperature with power modulation / Multifuel (pellets, almond shell, olive pit) / Vacuum cleaning system / Multiple safety systems / Stainless steel burning pot / Aluminium finned heat exchanger with no daily cleaning required / Hearth with vermiculite / Three ducted air outlets, maximum length 14 metres / Wheels for handling.

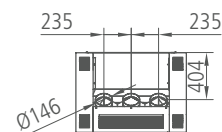
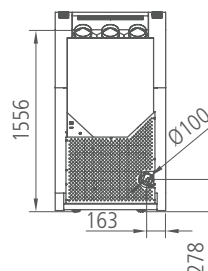
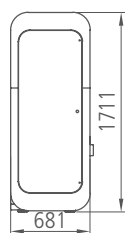
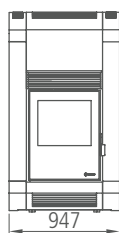



» info p58

Cordoba Glass Canalizable



Faça sobressair uma das paredes da sua casa com o nosso recuperador de vidro Cordoba Glass Canalizable.

Make one of the walls of your house stand out with our Cordoba Glass Canalizable pellet stove.



Cordoba Glass Canalizable

Insert



A+



WIFI
INTERNET
APP
INCL.



eco
SILENCE



CARACTERÍSTICAS TÉCNICAS

Potência: 12 kW
Rendimento: 91 %
Depósito: 25 kg
Consumo: 1,1 - 2,7 kg/h
Autonomia: 23 - 9 h
Peso: 138,5 kg
Diâmetro saída de gases: 80 mm
Diâmetro saída canalização de ar:
1x100 mm
EEI=125

TECHNICAL SPECIFICATIONS

Power: 12 kW
Performance: 91 %
Hopper: 25 kg
Consumption: 1,1 - 2,7 kg/h
Autonomy: 23 - 9 h
Weight: 138,5 kg
Gas outlet diameter: 80 mm
Ducted air outlet diameter:
1x100 mm
EEI=125

INCLUI

Controlo automático do fornecimento de ar de combustão, dos pellets e ar de convecção / Eletrónica exclusiva Ecoforest / Controlo e programação por potência ou por temperatura ambiente com modulação da potência / Policombustível (pellets, casca de amêndoa, caroço de azeitona) / Sistema de limpeza por vácuo / Múltiplos sistemas de segurança / Cesto queimador em ferro fundido / Intercâmbiador alheteado de alumínio sem necessidade de limpeza diária / Câmara de combustão reforçada em vermiculite / Tabuleiro de combustível de grande capacidade / Guias de extração do recuperador para facilitar a manutenção / Estrutura para montagem regulável em altura / Uma saída de ar canalizável, long. max. 7 m / Duas saídas de ar frontal / Frente decorativa em vidro preto temperado.

INCLUDING

Automatic modulation of combustion air, pellets supply and convection air / Ecoforest exclusive electronics / Control and programming by power or by room temperature with power modulation / Multifuel (pellets, almond shell, olive pit) / Vacuum cleaning system / Multiple safety systems / Cast iron burning pot / Aluminium finned heat exchanger with no daily cleaning required / Hearth with vermiculite / Large capacity fuel tray / Extraction guides for maintenance / Height-adjustable mounting structure / A ducted air outlet, maximum length 7 metres / Two front air outlets / Front in black tempered glass.

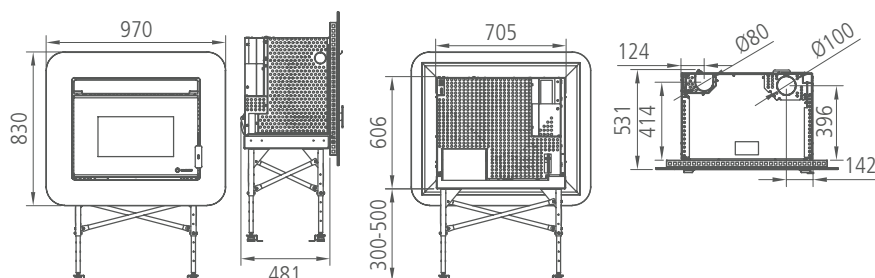

Cordoba Canalizable

Insert



A+



WiFi
INTERNET
APP
INCL.



eco
SILENCE



CARACTERÍSTICAS TÉCNICAS

Potência: 12 kW
Rendimento: 91 %
Depósito: 25 kg
Consumo: 1,1 - 2,7 kg/h
Autonomia: 23 - 9 h
Peso: 119,5 kg
Diâmetro saída de gases: 80 mm
Diâmetro saída canalização de ar:
1x100 mm
EEI=125

TECHNICAL SPECIFICATIONS

Power: 12 kW
Performance: 91 %
Hopper: 25 kg
Consumption: 1,1 - 2,7 kg/h
Autonomy: 23 - 9 h
Weight: 119,5 kg
Gas outlet diameter: 80 mm
Ducted air outlet diameter:
1x100 mm
EEI=125

INCLUI

Controlo automático do fornecimento de ar de combustão, dos pellets e ar de convecção / Eletrónica exclusiva Ecoforest / Controlo e programação por potência ou por temperatura ambiente com modulação da potência / Policombustível (pellets, casca de amêndoa, caroço de azeitona) / Sistema de limpeza por vácuo / Múltiplos sistemas de segurança / Cesto queimador em ferro fundido / Intercâmbiador alhetado de alumínio sem necessidade de limpeza diária / Câmara de combustão reforçada em vermiculite / Tabuleiro de combustível de grande capacidade / Guias de extração do recuperador para facilitar a manutenção / Uma saída de ar canalizável, long. max. 7 m / Duas saídas de ar frontal.

INCLUDING

Automatic modulation of combustion air, pellets supply and convection air / Ecoforest exclusive electronics / Control and programming by power or by room temperature with power modulation / Multifuel (pellets, almond shell, olive pit) / Vacuum cleaning system / Multiple safety systems / Cast iron burning pot / Aluminium finned heat exchanger with no daily cleaning required / Hearth with vermiculite / Large capacity fuel tray / Extraction guides for maintenance / A ducted air outlet, maximum length 7 metres / Two front air outlets.

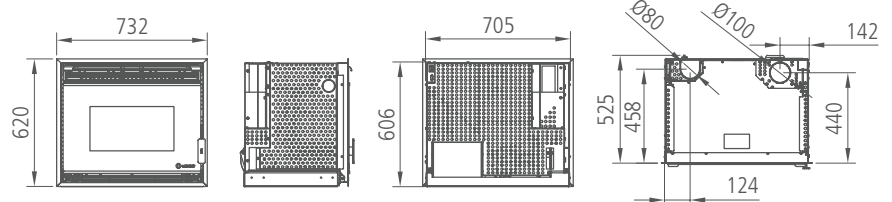

Granada

Insert



A+



WIFI
INTERNET
APP
INCL.



CARACTERÍSTICAS TÉCNICAS

Potência: 12 kW
Rendimento: 91 %
Depósito: 25 kg
Consumo: 1,1 - 2,7 kg/h
Autonomia: 23 - 9 h
Peso: 129 kg
Diâmetro saída de gases: 80 mm
Diâmetro saída canalização de ar:
1x100 mm
EEI=125

TECHNICAL SPECIFICATIONS

Power: 12 kW
Performance: 91 %
Hopper: 25 kg
Consumption: 1,1 - 2,7 kg/h
Autonomy: 23 - 9 h
Weight: 129 kg
Gas outlet diameter: 80 mm
Ducted air outlet diameter:
1x100 mm
EEI=125

INCLUI

Controlo automático do fornecimento de ar de combustão, dos pellets e ar de convecção / Eletrónica exclusiva Ecoforest / Controlo e programação por potência ou por temperatura ambiente com modulação da potência / Policombustível (pellets, casca de amêndoa, caroço de azeitona) / Sistema de limpeza por vácuo / Múltiplos sistemas de segurança / Cesto queimador em ferro fundido / Intercâmbiador alheteado de alumínio sem necessidade de limpeza diária / Câmara de combustão reforçada em vermiculite / Tabuleiro de combustível de grande capacidade / Guias de extração do recuperador para facilitar a manutenção / Estrutura para montagem regulável em altura / Acabamento aço inoxidável cromado (efeito espelho) / Uma saída de ar canalizável, long. max. 7 m / Duas saídas de ar frontal / Porta com vidro efeito espelhado.

INCLUDING

Automatic modulation of combustion air, pellets supply and convection air / Ecoforest exclusive electronics / Control and programming by power or by room temperature with power modulation / Multifuel (pellets, almond shell, olive pit) / Vacuum cleaning system / Multiple safety systems / Cast iron burning pot / Hearth with vermiculite / Aluminium finned heat exchanger with no daily cleaning required / Large capacity fuel tray / Extraction guides for maintenance / Height-adjustable mounting structure / Stainless steel finish (mirror effect) / A ducted air outlet, maximum length 7 metres / Two front air outlets / Fireplace door with mirror effect.

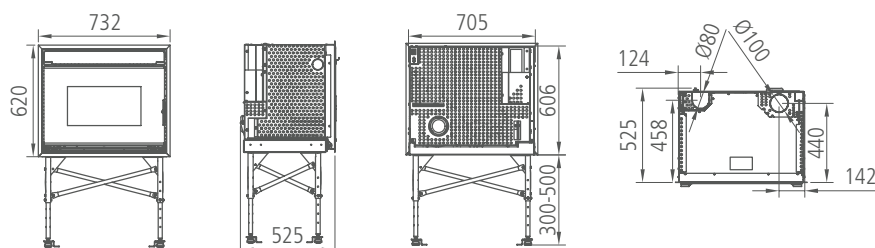

Teide

Insert



A+



WIFI
INTERNET
APP
INCL.



eco
SILENCE



CARACTERÍSTICAS TÉCNICAS

Potência: 12 kW
Rendimento: 91 %
Depósito: 25 kg
Consumo: 1,1 - 2,7 kg/h
Autonomia: 23 - 9 h
Peso: 129 kg
Diâmetro saída de gases: 80 mm
Diâmetro saída canalização de ar:
2x60 mm y 1x100 mm
EEI=125

TECHNICAL SPECIFICATIONS

Power: 12 kW
Performance: 91 %
Hopper: 25 kg
Consumption: 1,1 - 2,7 kg/h
Autonomy: 23 - 9 h
Weight: 129 kg
Gas outlet diameter: 80 mm
Ducted air outlet diameter:
2x60 mm et 1x100 mm
EEI=125

INCLUI

Controlo automático do fornecimento de ar de combustão, dos pellets e ar de convecção / Eletrónica exclusiva Ecoforest / Controlo e programação por potência ou por temperatura ambiente com modulação da potência / Policombustível (pellets, cásca de amêndoa, caroço de azeitona) / Sistema de limpeza por vácuo / Múltiplos sistemas de segurança / Cesto queimador em ferro fundido / Intercambiador alheteadado de alumínio sem necessidade de limpeza diária / Câmara de combustão reforçada em vermiculite / Tabuleiro de combustível de grande capacidade / Guias de extração do recuperador para facilitar a manutenção / Estrutura para montagem regulável em altura / Três saídas de ar canalizáveis, long. max. 7 m.

INCLUDING

Automatic modulation of combustion air, pellets supply and convection air / Ecoforest exclusive electronics / Control and programming by power or by room temperature with power modulation / Multifuel (pellets, almond shell, olive pit) / Vacuum cleaning system / Multiple safety systems / Cast iron burning pot / Aluminium finned heat exchanger with no daily cleaning required / Hearth with vermiculite / Large capacity fuel tray / Extraction guides for maintenance / Height-adjustable mounting structure / Three ducted air outlets, maximum length 7 metres.

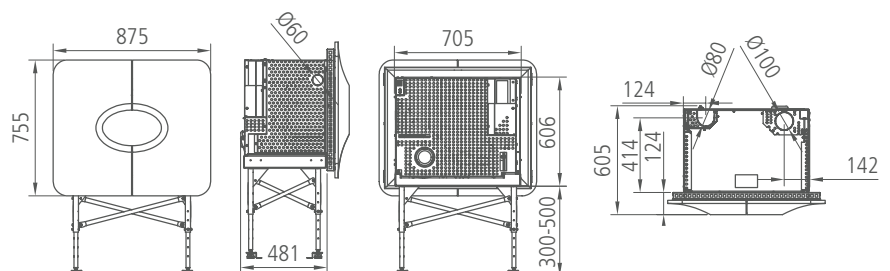

Boston

Insert



A+



WIFI
INTERNET
APP
INCL.



CARACTERÍSTICAS TÉCNICAS

Potência: 15 kW
Rendimento: 87,1 %
Depósito: 50 kg
Consumo: 1,6 - 3,5 kg/h
Autonomia: 31 - 14 h
Peso: 175 kg
Diâmetro saída de gases: 100 mm
Diâmetro saída canalização de ar:
2x120 mm
EEI=120

TECHNICAL SPECIFICATIONS

Power: 15 kW
Performance: 87,1 %
Hopper: 50 kg
Consumption: 1,6 - 3,5 kg/h
Autonomy: 31 - 14 h
Weight: 175 kg
Gas outlet diameter: 100 mm
Ducted air outlet diameter:
2x120 mm
EEI=120

INCLUI

Controlo automático do fornecimento de ar de combustão, dos pellets e ar de convecção / Eletrónica exclusiva Ecoforest / Controlo e programação por potência ou por temperatura ambiente com modulação da potência / Policombustível (pellets, casca de amêndoa, caroço de azeitona) / Sistema de limpeza por vácuo / Múltiplos sistemas de segurança / Cesto queimador em aço inoxidável / Intercâmbiador alhetado de alumínio sem necessidade de limpeza diária / Câmara de combustão reforçada em vermiculite / Duas saídas de ar canalizável, long. max. 7 m / Rodas para manuseamento / Frontal decorativo em vidro preto ou vermelho temperado.

INCLUDING

Automatic modulation of combustion air, pellets supply and convection air / Ecoforest exclusive electronics / Control and programming by power or by room temperature with power modulation / Multifuel (pellets, almond shell, olive pit) / Vacuum cleaning system / Multiple safety systems / Stainless steel burning pot / Aluminium finned heat exchanger with no daily cleaning required / Hearth with vermiculite / Two ducted air outlets, maximum length 7 metres / Wheels for handling / Front tempered glass in black or red.

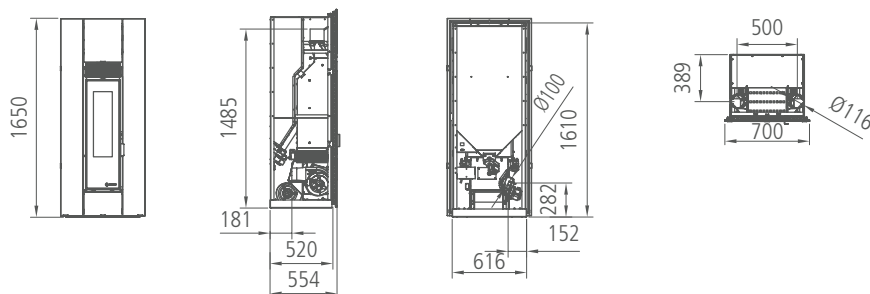

Milan

Insert



A+



WIFI
INTERNET
APP
INCL.



eco
SILENCE



CARACTERÍSTICAS TÉCNICAS

Potência: 16 kW
Rendimento: 92 %
Depósito: 60 kg
Consumo: 1,6 - 3,6 kg/h
Autonomia: 37 - 17 h
Peso: 210 kg
Diâmetro saída de gases: 100 mm
Diâmetro saída canalização de ar:
2x120 mm
EEI=125

TECHNICAL SPECIFICATIONS

Power: 16 kW
Performance: 92 %
Hopper: 60 kg
Consumption: 1,6 - 3,6 kg/h
Autonomy: 37 - 17 h
Weight: 210 kg
Gas outlet diameter: 100 mm
Ducted air outlet diameter:
2x120 mm
EEI=125

INCLUI

Controlo automático do fornecimento de ar de combustão, dos pellets e ar de convecção / Eletrónica exclusiva Ecoforest / Controlo e programação por potência ou por temperatura ambiente com modulação da potência / Policombustível (pellets, casca de amêndoa, caroço de azeitona) / Vacuum cleaning system / Múltiplos sistemas de segurança / Cesto queimador em aço inoxidável / Intercambiador alhetado de alumínio sem necessidade de limpeza diária / Câmara de combustão reforçada em vermiculite / Duas saídas de ar canalizável, long. max. 7 m / Rodas para manuseamento.

INCLUDING

Automatic modulation of combustion air, pellets supply and convection air / Ecoforest exclusive electronics / Control and programming by power or by room temperature with power modulation / Multifuel (pellets, almond shell, olive pit) / Vacuum cleaning system / Multiple safety systems / Stainless steel burning pot / Aluminium finned heat exchanger with no daily cleaning required / Hearth with vermiculite / Two ducted air outlets, maximum length 7 metres / Wheels for handling.

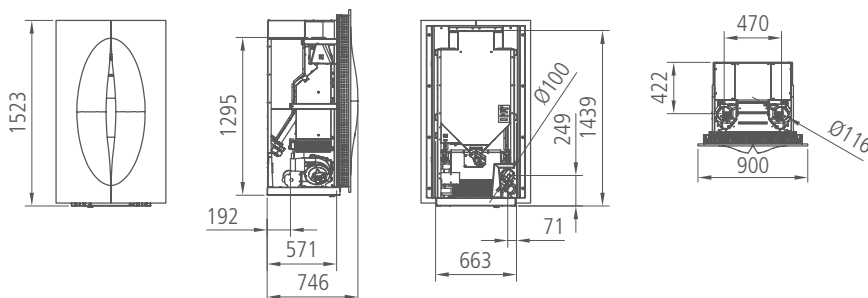

Kiev

Insert



A+



WIFI
INTERNET
APP
INCL.



eco
SILENCE



CARACTERÍSTICAS TÉCNICAS

Potência: 16 kW
Rendimento: 92 %
Depósito: 60 kg
Consumo: 1,6 - 3,6 kg/h
Autonomia: 37 - 17 h
Peso: 190 kg
Diâmetro saída de gases: 100 mm
Diâmetro saída canalização de ar:
2x120 mm
EEI=125

TECHNICAL SPECIFICATIONS

Power: 16 kW
Performance: 92 %
Hopper: 60 kg
Consumption: 1,6 - 3,6 kg/h
Autonomy: 37 - 17 h
Weight: 190 kg
Gas outlet diameter: 100 mm
Ducted air outlet diameter:
2x120 mm
EEI=125

INCLUI

Controlo automático do fornecimento de ar de combustão, dos pellets e ar de convecção / Eletrónica exclusiva Ecoforest / Controlo e programação por potência ou por temperatura ambiente com modulação da potência / Policombustível (pellets, casca de amêndoa, caroço de azeitona) / Sistema de limpeza por vácuo / Múltiplos sistemas de segurança / Cesto queimador em aço inoxidável / Intercambiador alhetado de alumínio sem necessidade de limpeza diária / Câmara de combustão reforçada em vermiculite / Duas saídas de ar canalizável, long. max. 7 m / Rodas para manuseamento / Frente decorativa em vidro preto temperado / Possibilidade de inverter a porta do depósito de combustível (acessórios opcionais).

INCLUDING

Automatic modulation of combustion air, pellets supply and convection air / Ecoforest exclusive electronics / Control and programming by power or by room temperature with power modulation / Multifuel (pellets, almond shell, olive pit) / Vacuum cleaning system / Multiple safety systems / Stainless steel burning pot / Aluminium finned heat exchanger with no daily cleaning required / Hearth with vermiculite / Two ducted air outlets, maximum length 7 metres / Wheels for handling / Front in black tempered glass / Possibility to invert hopper door swing direction towards a right-hand door (optional accessories).

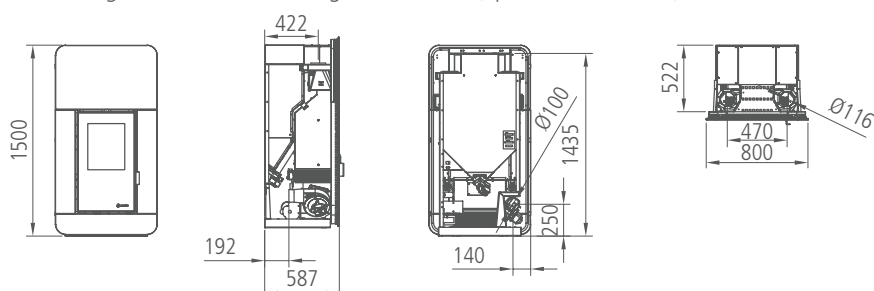

Oslo

Insert



A+



WIFI
INTERNET
APP
INCL.



eco
SILENCE



CARACTERÍSTICAS TÉCNICAS

Potência: 30 kW
Rendimento: 92,3 %
Depósito: 90 kg
Consumo: 2,9 - 6,8 kg/h
Autonomia: 31 - 13 h
Peso: 240 kg
Diâmetro saída de gases: 100 mm
Diâmetro saída canalização de ar:
3x150 mm
EEI=124

TECHNICAL SPECIFICATIONS

Power: 30 kW
Performance: 92,3 %
Hopper: 90 kg
Consumption: 2,9 - 6,8 kg/h
Autonomy: 31 - 13 h
Weight: 240 kg
Gas outlet diameter: 100 mm
Ducted air outlet diameter:
3x150 mm
EEI=124

INCLUI

Controlo automático do fornecimento de ar de combustão, dos pellets e ar de convecção / Eletrónica exclusiva Ecoforest / Controlo e programação por potência ou por temperatura ambiente com modulação da potência / Policombustível (pellets, casca de amêndoa, caroço de azeitona) / Sistema de limpeza por vácuo / Múltiplos sistemas de segurança / Cesto queimador em aço inoxidável / Intercâmbiador alhetado de alumínio sem necessidade de limpeza diária / Câmara de combustão reforçada em vermiculite / Três saídas de ar canalizáveis, long. max. 14 m / Rodas para manuseamento / Frente decorativa em vidro preto temperado / Opcional: porta de carga lateral.

INCLUDING

Automatic modulation of combustion air, pellets supply and convection air / Ecoforest exclusive electronics / Control and programming by power or by room temperature with power modulation / Multifuel (pellets, almond shell, olive pit) / Vacuum cleaning system / Multiple safety systems / Panier perforé en acier inoxydable / Aluminium finned heat exchanger with no daily cleaning required / Hearth with vermiculite / Three ducted air outlets, maximum length 14 metres / Wheels for handling / Front in black tempered glass / Optional: loading trap door.

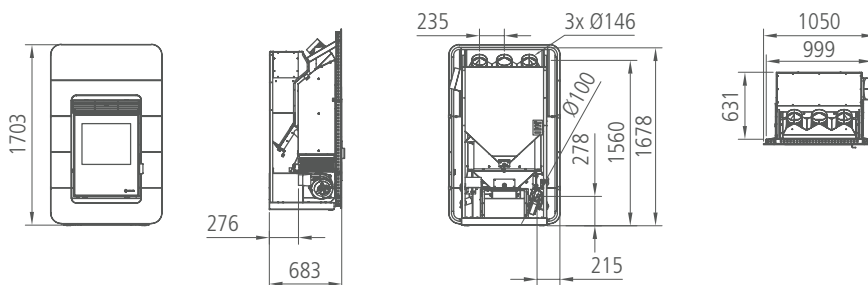

Água Water



Os novos permutadores de calor para caldeiras e hidro salamandras ou recuperadores concebidos pela Ecoforest melhoram a transmissão das caldeiras tradicionais, aumentando o desempenho e a poupança proporcionada pelos nossos produtos, conseguindo assim um maior conforto com um menor consumo de combustível.

The new heat exchangers for boilers and hydro-stoves designed by Ecoforest improve the transmission of traditional boilers, increasing the performance and savings provided by our products, thus achieving greater comfort with lower fuel consumption.



Diagrama de instalação hidráulica
Scheme of a hydraulic installation



Foto ilustrativa
Non-contractual picture

VANTAGENS

ECOFOREST - ÁGUA



ECODESIGNO



MODULAÇÃO AUTOMÁTICA

Modulação do fluxo de combustão e circulação; impulsão direta sem inércia; controle automático da temperatura de retorno sem a necessidade de válvula de condensação. Controle modulante da combustão. Tecnologia Ecoforest. As caldeiras a pellets Ecoforest são inteligentes, com a finalidade de adaptar o funcionamento às necessidades da instalação e às características do pellet.



SIMPLICIDADE



GESTÃO ATRAVÉS DA APP



CURVA DE AQUECIMENTO



CONTROLE DE LEGIONELA NO ACUMULADOR DE A.Q.S.

ADVANTAGES

ECOFORREST - WATER



ECODESIGN



AUTOMATIC MODULATION

Modulation of the combustion and circulator flow; direct supply without buffer tank (depending on the scheme); automatic control of the supply and return temperatures without any anticondensation valves. Ecoforest technology. Ecoforest pellet boilers are intelligent, as they are capable of adapting to installation needs and to pellet characteristics.



EASY-TO-USE



APP MANAGEMENT



HEATING CURVE

CONTROL

CLASS 5
Gas output temperature between 65 °C and 135 °C

- BURNER WITH AUTOMATIC CLEANING
- AUTOMATIC ASH COMPACTOR
- HEAT EXCHANGER WITH AUTOMATIC CLEANING

CONTROL OF EXTERNAL SILO

CONTROL OF 3-WAY VALVE (DHW / HEATING)



LEGIONELA CONTROL IN DHW TANK

Hidrocooper 18



A++



WIFI
INTERNET
APP
INCL.



Estanque
Airtight



CARACTERÍSTICAS TÉCNICAS

Potência: 18 kW
Rendimento: 95 %
Depósito: 23 kg
Consumo: 2 - 3,9 kg/h
Autonomia: 12 - 6 h
Peso: 133 kg
Diâmetro saída de gases: 100 mm
Diâmetro entrada de ar: 60 mm
EEI=132

TECHNICAL SPECIFICATIONS

Power: 18 kW
Performance: 95 %
Hopper: 23 kg
Consumption: 2 - 3,9 kg/h
Autonomy: 12 - 6 h
Weight: 133 kg
Gas outlet diameter: 100 mm
Gas inlet diameter: 60 mm
EEI=132

INCLUI

Controlo automático do fornecimento de ar de combustão, dos pellets e da bomba circuladora / Anti-condensação eletrónico (Regulação por software da temperatura de impulsão e do retorno sem válvula anti condensação) / Controlo de depósito A.Q.S. inércia e silos externos / Eletrónica exclusiva Ecoforest / Controlo e programação por potência ou por temperatura ambiente com modulação da potência / Policombustível (pellets, caroço de azeitona) / Sistema de limpeza por vácuo / Múltiplos sistemas de segurança / Câmara de combustão reforçada em fundição / Cesto queimador em ferro fundido com asas de aço inoxidável / Inclui bomba circuladora, vaso de expansão e válvula de segurança / Frontal e parte superior decorativo em vidro preto temperado.

INCLUDING

Automatic control of combustion air, fuel supply and recirculating pump flow / Software regulation of flow and return temperatures without anti-condensation valve / Possibility to control DHW tank, buffer and hopper / Ecoforest exclusive electronics / Control and programming by power or by room temperature with power modulation / Multifuel (pellets, olive pit) / Vacuum cleaning system / Multiple safety systems / Hearth with cast iron / Cast iron burning pot with stainless steel wings / Including circulation pump, expansion valve and safety valve / Front and top in black tempered glass.

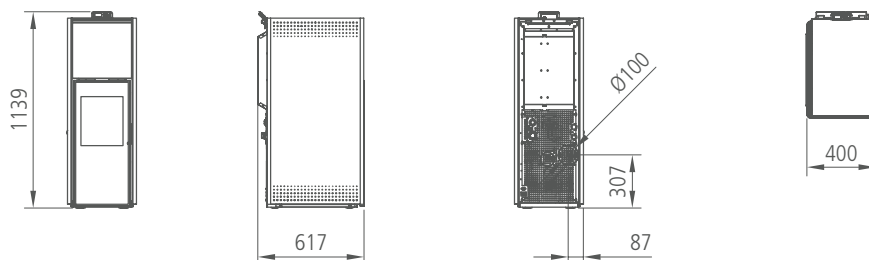

Hidrocooper 18 slim



A++



WIFI
INTERNET
APP
INCL.



CARACTERÍSTICAS TÉCNICAS

Potência: 18 kW
Rendimento: 95 %
Depósito: 36 kg
Consumo: 2 - 3,9 kg/h
Autonomia: 18 - 9 h
Peso: 154 kg
Diâmetro saída de gases: 100 mm
Diâmetro entrada de ar: 60 mm
EEI=132

TECHNICAL SPECIFICATIONS

Power: 18 kW
Performance: 95 %
Hopper: 36 kg
Consumption: 2 - 3,9 kg/h
Autonomy: 18 - 9 h
Weight: 154 kg
Gas outlet diameter: 100 mm
Gas inlet diameter: 60 mm
EEI=132

INCLUI

Controlo automático do fornecimento de ar de combustão, dos pellets e da bomba circuladora / Anti-condensação eletrónico (Regulação por software da temperatura de impulsão e do retorno sem válvula anti condensação) / Controlo de depósito A.Q.S. inércia e silos externos / Eletrónica exclusiva Ecoforest / Controlo e programação por potência ou por temperatura ambiente com modulação da potência / Policombustível (pellets, caroço de azeitona) / Sistema de limpeza por vácuo / Múltiplos sistemas de segurança / Câmara de combustão reforçada em fundição / Cesto queimador em ferro fundido com asas de aço inoxidável / Inclui bomba circuladora, vaso de expansão e válvula de segurança / Frontal e parte superior decorativo em vidro preto temperado.

INCLUDING

Automatic control of combustion air, fuel supply and recirculating pump flow / Software regulation of flow and return temperatures without anti-condensation valve / Possibility to control DHW tank, buffer and hopper / Ecoforest exclusive electronics / Control and programming by power or by room temperature with power modulation / Multifuel (pellets, olive pit) / Vacuum cleaning system / Multiple safety systems / Hearth with cast iron / Cast iron burning pot with stainless steel wings / Including circulation pump, expansion valve and safety valve / Front and top in black tempered glass.

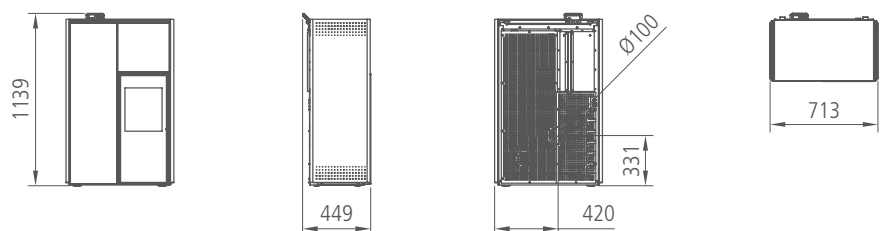

Hydrocooper 18 slim plus



A++



WIFI
INTERNET
APP
INCL.



Estanque
Airtight



CARACTERÍSTICAS TÉCNICAS

Potência: 18 kW
Rendimento: 95 %
Depósito: 36 kg
Consumo: 2 - 3,9 kg/h
Autonomia: 18 - 9 h
Peso: 162 kg
Diâmetro saída de gases: 100 mm
Diâmetro entrada de ar: 60 mm
EEI=132

TECHNICAL SPECIFICATIONS

Power: 18 kW
Performance: 95 %
Hopper: 36 kg
Consumption: 2 - 3,9 kg/h
Autonomy: 18 - 9 h
Weight: 162 kg
Gas outlet diameter: 100 mm
Gas inlet diameter: 60 mm
EEI=132

INCLUI

Controlo automático do fornecimento de ar de combustão, dos pellets e da bomba circuladora / Anti-condensação eletrónico (Regulação por software da temperatura de impulsão e do retorno sem válvula anti condensação) / Controlo de depósito A.Q.S. inércia e silos externos / Eletrónica exclusiva Ecoforest / Controlo e programação por potência ou por temperatura ambiente com modulação da potência / Policombustível (pellets, caroço de azeitona) / Sistema de limpeza por vácuo / Múltiplos sistemas de segurança / Câmara de combustão reforçada em fundição / Cesto queimador em ferro fundido com asas de aço inoxidável / Inclui bomba circuladora, vaso de expansão e válvula de segurança / Frontal e parte superior decorativo em vidro preto temperado / Possibilidade de saída de gases traseira ou superior (tubagem interna não incluída).

INCLUDING

Automatic control of combustion air, fuel supply and recirculating pump flow / Software regulation of flow and return temperatures without anti-condensation valve / Possibility to control DHW tank, buffer and hopper / Ecoforest exclusive electronics / Control and programming by power or by room temperature with power modulation / Multifuel (pellets, olive pit) / Vacuum cleaning system / Multiple safety systems / Hearth with cast iron / Cast iron burning pot with stainless steel wings / Including circulation pump, expansion valve and safety valve / Front and top in black tempered glass / Top or rear smoke outlet possibility (internal flue pipes not included).

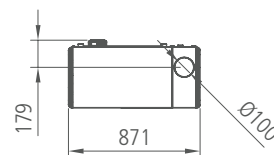
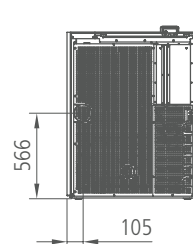
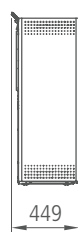
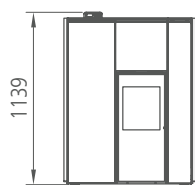

Hidrocooper 24 slim



A++



WIFI
INTERNET
APP
INCL.



Estanque
Airtight



CARACTERÍSTICAS TÉCNICAS

Potência: 23,6 kW
Rendimento: 94 %
Depósito: 40 kg
Consumo: 2 - 5,1 kg/h
Autonomia: 20 - 8 h
Peso: 171 kg
Diâmetro saída de gases: 100 mm
Diâmetro entrada de ar: 60 mm
EEI=131

TECHNICAL SPECIFICATIONS

Power: 23,6 kW
Performance: 94 %
Hopper: 40 kg
Consumption: 2 - 5,1 kg/h
Autonomy: 20 - 8 h
Weight: 171 kg
Gas outlet diameter: 100 mm
Gas inlet diameter: 60 mm
EEI=131

INCLUI

Controlo automático do fornecimento de ar de combustão, dos pellets e da bomba circuladora / Anti-condensação eletrónico (Regulação por software da temperatura de impulsão e do retorno sem válvula anti condensação) / Controlo de depósito A.Q.S. inércia e silos externos / Eletrónica exclusiva Ecoforest / Controlo e programação por potência ou por temperatura ambiente com modulação da potência / Vacuum cleaning system / Múltiplos sistemas de segurança / Câmara de combustão reforçada em fundição / Cesto queimador em ferro fundido com asas de aço inoxidável / Inclui bomba circuladora, vaso de expansão e válvula de segurança / Frente decorativa em vidro preto temperado.

INCLUDING

Automatic control of combustion air, fuel supply and recirculating pump flow / Software regulation of flow and return temperatures without anti-condensation valve / Possibility to control DHW tank, buffer and hopper / Ecoforest exclusive electronics / Control and programming by power or by room temperature with power modulation / Vacuum cleaning system / Multiple safety systems / Hearth with cast iron / Cast iron burning pot with stainless steel wings / Including circulation pump, expansion valve and safety valve / Front and top in black tempered glass.

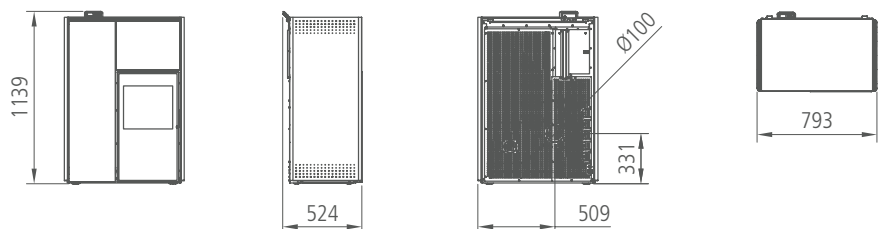

Dublin II

Insert



A+



WIFI
INTERNET
APP
INCL.



CARACTERÍSTICAS TÉCNICAS

Potência: 14 kW
Rendimento: 92,5 %
Depósito: 30 kg
Consumo: 1,5 - 3,2 kg/h
Autonomia: 20 - 9 h
Peso: 134 kg
Diâmetro saída de gases: 80 mm
EEI=124

TECHNICAL SPECIFICATIONS

Power: 14 kW
Performance: 92,5 %
Hopper: 30 kg
Consumption: 1,5 - 3,2 kg/h
Autonomy: 20 - 9 h
Weight: 134 kg
Gas outlet diameter: 80 mm
EEI=124

INCLUI

Controlo automático do fornecimento de ar de combustão, dos pellets e da bomba circuladora / Anti-condensação eletrónico (Regulação por software da temperatura de impulsão e do retorno sem válvula anti condensação) / Controlo de depósito A.Q.S. inércia e silos externos / Eletrónica exclusiva Ecoforest / Controlo e programação por potência ou por temperatura ambiente com modulação da potência / Policombustível (pellets, casca de amêndoa, caroço de azeitona) / Sistema de limpeza por vácuo / Múltiplos sistemas de segurança / Câmara de combustão reforçada em fundição / Cesto queimador em ferro fundido / Intercâmbiador em aço inoxidável / Inclui bomba circuladora, vaso de expansão e válvula de segurança / Rodas para manuseamento / Tabuleiro de combustível de grande capacidade / Frontal decorativo em vidro preto temperado.

INCLUDING

Automatic control of combustion air, fuel supply and recirculating pump flow / Software regulation of flow and return temperatures without anti-condensation valve / Possibility to control DHW tank, buffer and hopper / Ecoforest exclusive electronics / Control and programming by power or by room temperature with power modulation / Multifuel (pellets, almond shell, olive pit) / Vacuum cleaning system / Multiple safety systems / Hearth with cast iron / Cast iron burning pot / Stainless steel heat exchanger / Including circulation pump, expansion valve and safety valve / Wheels for handling / Large capacity fuel tray / Front black tempered glass.

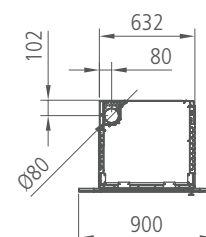
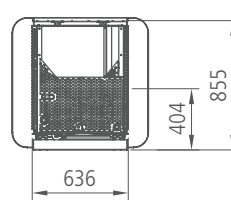
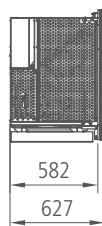
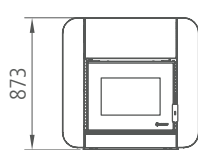

Super Insert II

Insert



A+



WIFI
INTERNET
APP
INCL.

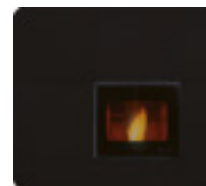

CARACTERÍSTICAS TÉCNICAS

Potência: 24 / 30 kW
Rendimento: 92,8 % / 92,5 %
Depósito: 109 kg
Consumo: 2,1 - 5,2 / 2,1 - 6,6 kg/h
Autonomia: 53 - 21 / 51 - 16 h
Peso: 260 kg
Diâmetro saída de gases: 100 mm
EEI=129 / 127

TECHNICAL SPECIFICATIONS

Power: 24 / 30 kW
Performance: 92,8 % / 92,5 %
Hopper: 109 kg
Consumption: 2,1 - 5,2 / 2,1 - 6,6 kg/h
Autonomy: 53 - 21 / 51 - 16 h
Weight: 260 kg
Gas outlet diameter: 100 mm
EEI=129 / 127

INCLUI

Controlo automático do fornecimento de ar de combustão, dos pellets e da bomba circuladora / Anti-condensação eletrónico (Regulação por software da temperatura de impulsão e do retorno sem válvula anti condensação) / Possibilidade de controlo de depósito A.Q.S. inércia e silos externos / Eletrónica exclusiva Ecoforest / Controlo e programação por potência ou por temperatura ambiente com modulação da potência / Policombustível (pellets, casca de amêndoa, caroço de azeitona) / Sistema de limpeza por vácuo / Múltiplos sistemas de segurança / Câmara de combustão reforçada em vermiculite / Cesto queimador em ferro fundido / Intercambiador em aço inoxidável / Inclui bomba circuladora, vaso de expansão e válvula de segurança / Rodas para manuseamento / Limpeza automática do intercambiador.

INCLUDING

Automatic control of combustion air, fuel supply and recirculating pump flow / Software regulation of flow and return temperatures without anti-condensation valve / Possibility to control DHW tank, buffer and hopper / Ecoforest exclusive electronics / Control and programming by power or by room temperature with power modulation / Multifuel (pellets, almond shell, olive pit) / Vacuum cleaning system / Multiple safety systems / Hearth with vermiculite / Cast iron burning pot / Stainless steel heat exchanger / Including circulation pump, expansion valve and safety valve / Wheels for handling / Automatic cleaning of the heat exchanger.

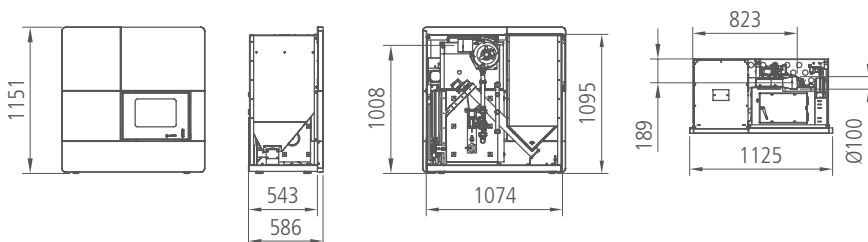

Caldeiras a pellets

Pellet boilers



O futuro das caldeiras de pellets é a produção com eficiências superiores a 90% e emissões reduzidas, de modo a garantir a qualidade do ar. Algumas das caldeiras de pellets Ecoforest foram aprovadas como Classe 5, o que garante a conformidade com os regulamentos europeus mais exigentes e, portanto, são adequadas para venda em qualquer país europeu.

The future of pellet boilers lies in those boilers with efficiencies of over 90% and reduced emissions, in such a way as to guarantee air quality. Some of the Ecoforest pellet boilers have been approved as Class 5, which guarantees compliance with the most demanding European regulations and, therefore, are suitable for sale in any European country.





Cantina Compact



A+



WIFI
INTERNET
APP
INCL.



CARACTERÍSTICAS TÉCNICAS

Potência: 12 kW
Rendimento: 90 %
Depósito: 40 kg
Consumo: 1,3 - 2,7 kg/h
Autonomia: 30 - 15 h
Peso: 170 kg
Diâmetro saída de gases: 80 mm
EEI=118

TECHNICAL SPECIFICATIONS

Power: 12 kW
Performance: 90 %
Hopper: 40 kg
Consumption: 1,3 - 2,7 kg/h
Autonomy: 30 - 15 h
Weight: 170 kg
Gas outlet diameter: 80 mm
EEI=118

INCLUI

Controlo automático do fornecimento de ar de combustão, dos pellets e da bomba circuladora / Anti-condensação eletrónico (Regulação por software da temperatura de impulsão e do retorno sem válvula anti condensação) / Controlo de depósito A.Q.S. inércia e silos externos / Eletrónica exclusiva Ecoforest / Controlo e programação por potência ou por temperatura ambiente com modulação da potência / Policombustível (pellets, casca de amêndoa, caroço de azeitona) / Múltiplos sistemas de segurança / Câmara de combustão reforçada em vermiculite / Cesto queimador em aço inoxidável / Inclui bomba circuladora, vaso de expansão e válvula de segurança / Rodas para manuseamento.

INCLUDING

Automatic control of combustion air, fuel supply and recirculating pump flow / Software regulation of flow and return temperatures without anti-condensation valve / Possibility to control DHW tank, buffer and hopper / Ecoforest exclusive electronics / Control and programming by power or by room temperature with power modulation / Multifuel (pellets, almond shell, olive pit) / Multiple safety systems / Hearth with vermiculite / Stainless steel burning pot / Including circulation pump, expansion valve and safety valve / Wheels for handling.

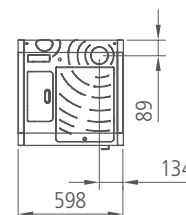
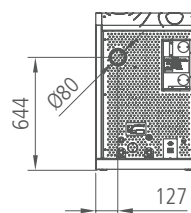
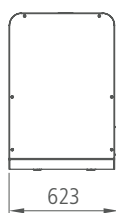
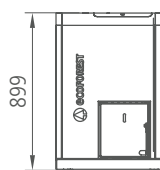

Cantina Super

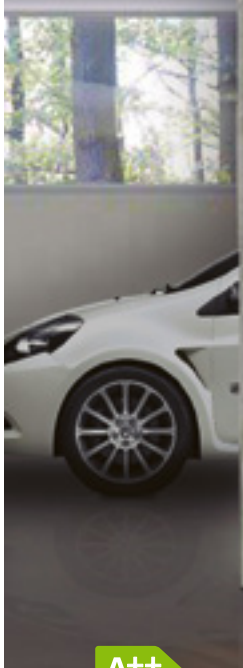

A++



WIFI
INTERNET
APP
INCL.



CARACTERÍSTICAS TÉCNICAS

Potência: 29 kW
Rendimento: 91 %
Depósito: 60 kg
Consumo: 1,9 - 6,4 kg/h
Autonomia: 32 - 9 h
Peso: 215 kg
Diâmetro saída de gases: 100 mm
EEI=126

TECHNICAL SPECIFICATIONS

Power: 29 kW
Performance: 91 %
Hopper: 60 kg
Consumption: 1,9 - 6,4 kg/h
Autonomy: 32 - 9 h
Weight: 215 kg
Gas outlet diameter: 100 mm
EEI=126

INCLUI

Controlo automático do fornecimento de ar de combustão, dos pellets e da bomba circuladora / Anti-condensação eletrónico (Regulação por software da temperatura de impulsão e do retorno sem válvula anti condensação) / Controlo de depósito A.Q.S. inércia e silos externos / Eletrónica exclusiva Ecoforest / Controlo e programação por potência ou por temperatura ambiente com modulação da potência / Policombustível (pellets, cásca de amêndoa, caroço de azeitona) / Vacuum cleaning system / Múltiplos sistemas de segurança / Câmara de combustão reforçada em fundição / Cesto em aço inoxidável / Intercâmbiador em aço inoxidável / Inclui bomba circuladora, vaso de expansão e válvula de segurança / Possibilidade inverter sistema de limpeza do intercâmbiador (direita/esquerda) / Possibilidade anexar tolva externa.

INCLUDING

Automatic control of combustion air, fuel supply and recirculating pump flow / Software regulation of flow and return temperatures without anti-condensation valve / Possibility to control DHW tank, buffer and hopper / Ecoforest exclusive electronics / Control and programming by power or by room temperature with power modulation / Multifuel (pellets, almond shell, olive pit) / Vacuum cleaning system / Multiple safety systems / Hearth with cast iron / Stainless steel burning pot / Stainless steel heat exchanger / Including circulation pump, expansion valve and safety valve / Possibility of inverting the cleaning handles / Possibility to attach hopper.

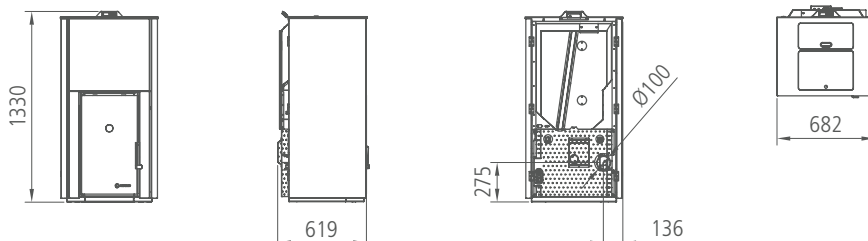

Cantina Nova



A++



WIFI
INTERNET
APP
INCL.



CARACTERÍSTICAS TÉCNICAS

Potência: 24 / 30 kW
Rendimento: 95,1 / 93,1 %
Depósito: 116 kg
Consumo: 2,4 - 5,2 / 2,9 - 6,5 kg/h
Autonomia: 49 - 22 / 40 - 18 h
Peso: 330 kg
Diâmetro saída de gases: 100 mm
EEI=130 / 128

TECHNICAL SPECIFICATIONS

Power: 24 / 30 kW
Performance: 95,1 / 93,1 %
Hopper: 116 kg
Consumption: 2,4 - 5,2 / 2,9 - 6,5 kg/h
Autonomy: 49 - 22 / 40 - 18 h
Weight: 330 kg
Gas outlet diameter: 100 mm
EEI=130 / 128

INCLUI

Controlo automático do fornecimento de ar de combustão, dos pellets e da bomba circuladora / Anti-condensação eletrónico (Regulação por software da temperatura de impulsão e do retorno sem válvula anti condensação) / Controlo de depósito A.Q.S. inércia e silos externos / Eletrónica exclusiva Ecoforest / Controlo e programação por potência ou por temperatura ambiente com modulação da potência / Policombustível (pellets, casca de amêndoa, caroço de azeitona) / Sistema de limpeza por vácuo / Múltiplos sistemas de segurança / Hearth with vermiculite / Cesto queimador em ferro fundido / Intercambiador em aço inoxidável / Inclui bomba circuladora, vaso de expansão e válvula de segurança / Rodas para manuseamento / Limpeza automática do intercambiador.

INCLUDING

Automatic control of combustion air, fuel supply and recirculating pump flow / Automatic control of combustion air, fuel supply and recirculating pump flow / Possibility to control DHW tank, buffer and hopper / Ecoforest exclusive electronics / Control and programming by power or by room temperature with power modulation / Multifuel (pellets, almond shell, olive pit) / Vacuum cleaning system / Multiple safety systems / Hearth with vermiculite / Cast iron burning pot / Echangeur en acier inoxydable / Including circulation pump, expansion valve and safety valve / Wheels for handling / Automatic cleaning of the heat exchanger.

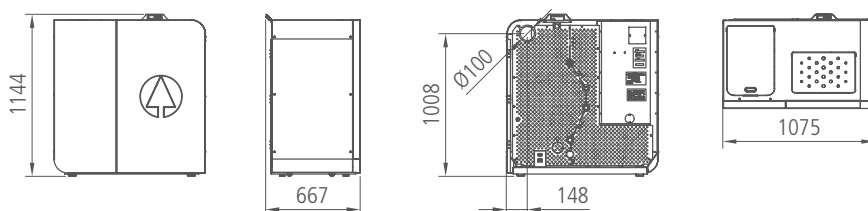

Vap 5-20



A++



WIFI
INTERNET
APP
INCL.



CARACTERÍSTICAS TÉCNICAS

Potência: 20 kW
Rendimento: 94 %
Depósito: 67 kg
Consumo: 1,1 - 4,4 kg/h
Autonomia: 62 - 15 h
Peso: 253 kg
Diâmetro saída de gases: 100 mm
EEI=131
Classe (UNE-EN 303-5:2013): 5

TECHNICAL SPECIFICATIONS

Power: 20 kW
Performance: 94 %
Hopper: 67 kg
Consumption: 1,1 - 4,4 kg/h
Autonomy: 62 - 15 h
Weight: 253 kg
Gas outlet diameter: 100 mm
EEI=131
Classe (UNE-EN 303-5:2013): 5

INCLUI

Controlo automático do fornecimento de ar de combustão, dos pellets e da bomba circuladora / Anti-condensação eletrónico (Regulação por software da temperatura de impulsão e do retorno sem válvula anti condensação) / Controlo de depósito A.Q.S. inércia e silos externos / Eletrónica exclusiva Ecoforest / Controlo e programação por potência ou por temperatura ambiente com modulação da potência / Múltiplos sistemas de segurança / Sistema de limpeza automático do intercâmbiador, cesto queimador e compactador das cinzas / Caixa de cinzas externa e extraível / Câmara de combustão reforçada em vermiculite / Cesto queimador em aço inoxidável / Inclui bomba circuladora, vaso de expansão e válvula de segurança.

INCLUDING

Automatic control of combustion air, fuel supply and recirculating pump flow / Software regulation of flow and return temperatures without anti-condensation valve / Possibility to control DHW tank, buffer and hopper / Ecoforest exclusive electronics / Control and programming by power or by room temperature with power modulation / Multiple safety systems / Automatic cleaning system for the exchanger, burning pot and ash compactor / External and removable ashtray drawer / Hearth with vermiculite / Stainless steel burning pot / Including circulation pump, expansion valve and safety valve.

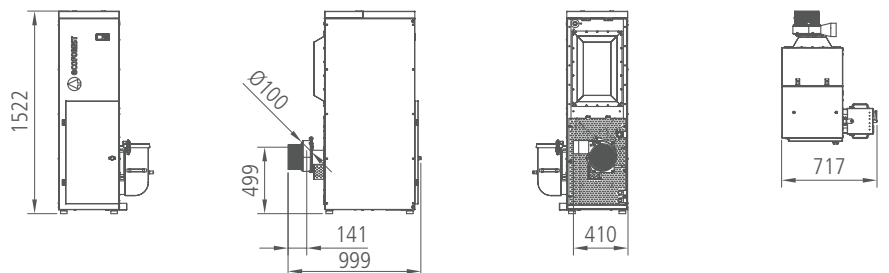

Vap 24

A++



WIFI
INTERNET
APP
INCL.



CARACTERÍSTICAS TÉCNICAS

Potência: 24 kW
Rendimento: 93,7 %
Depósito: 54 kg
Consumo: 1,4 - 5,2 kg/h
Autonomia: 39 - 10 h
Peso: 250 kg
Diâmetro saída de gases: 100 mm
EEI=132
Clase (UNE-EN 303-5:2013): 5

TECHNICAL SPECIFICATIONS

Power: 24 kW
Performance: 93,7 %
Hopper: 54 kg
Consumption: 1,4 - 5,2 kg/h
Autonomy: 39 - 10 h
Weight: 250 kg
Gas outlet diameter: 100 mm
EEI=132
Classe (UNE-EN 303-5:2013): 5

INCLUI

Controlo automático do fornecimento de ar de combustão, dos pellets e da bomba circuladora / Anti-condensação eletrónico (Regulação por software da temperatura de impulsão e do retorno sem válvula anti condensação) / Controlo de depósito A.Q.S. inércia e silos externos / Eletrónica exclusiva Ecoforest / Controlo e programação por potência ou por temperatura ambiente com modulação da potência / Múltiplos sistemas de segurança / Sistema de limpeza automático do intercambiador, cesto queimador e compactador das cinzas / Caixa de cinzas externa e extraível / Câmara de combustão reforçada em vermiculite / Cesto queimador em ferro fundido / Inclui bomba circuladora, vaso de expansão e válvula de segurança.

INCLUDING

Automatic control of combustion air, fuel supply and recirculating pump flow / Software regulation of flow and return temperatures without anti-condensation valve / Possibility to control DHW tank, buffer and hopper / Ecoforest exclusive electronics / Control and programming by power or by room temperature with power modulation / Multiple safety systems / Automatic cleaning system for the exchanger, burner basket and ash compactor / External and removable ashtray drawer / Hearth with vermiculite / Cast iron burning pot / Including circulation pump, expansion valve and safety valve.

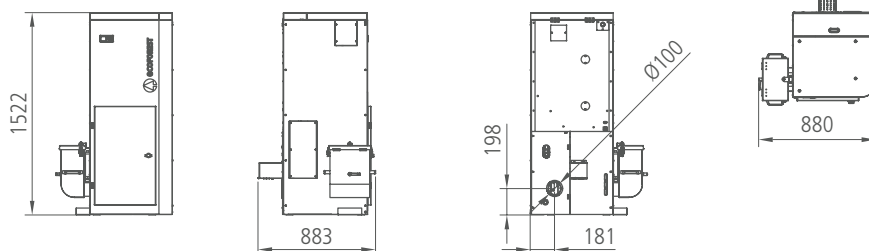



Vap 24



Caldeira de alta eficiência com limpeza automática, ideal para as instalações com os mais altos requisitos de eficiência e conforto.

High efficiency boiler with automatic cleaning, ideal for those installations with the highest requirements of efficiency and comfort.

Vap 30



A++



WIFI
INTERNET
APP
INCL.



CARACTERÍSTICAS TÉCNICAS

Potência: 30,2 kW
Rendimento: 90,2 %
Depósito: 132 kg
Consumo: 1,8 - 6,7 kg/h
Autonomia: 74 - 20 h
Peso: 430 kg
Diâmetro saída de gases: 100 mm
EEI=126
Clase (UNE-EN 303-5:2013): 5

TECHNICAL SPECIFICATIONS

Power: 30,2 kW
Performance: 90,2 %
Hopper: 132 kg
Consumption: 1,8 - 6,7 kg/h
Autonomy: 74 - 20 h
Weight: 430 kg
Gas outlet diameter: 100 mm
EEI=126
Classe (UNE-EN 303-5:2013): 5

INCLUI

Controlo automático do fornecimento de ar de combustão, dos pellets e da bomba circuladora / Anti-condensação eletrónico (Regulação por software da temperatura de impulsão e do retorno sem válvula anti condensação) / Controlo de depósito A.Q.S. inércia e silos externos / Eletrónica exclusiva Ecoforest / Controlo e programação por potência ou por temperatura ambiente com modulação da potência / Múltiplos sistemas de segurança / Sistema de limpeza automático do intercambiador, cesto queimador e compactador das cinzas / Caixa de cinzas externa e extraível / Câmara de combustão reforçada em vermiculite / Cesto queimador em aço inoxidável / Inclui bomba circuladora, vaso de expansão e válvula de segurança / Possibilidade de desmontagem do depósito para instalação.

INCLUDING

Automatic control of combustion air, fuel supply and recirculating pump flow / Software regulation of flow and return temperatures without anti-condensation valve / Possibility to control DHW tank, buffer and hopper / Ecoforest exclusive electronics / Control and programming by power or by room temperature with power modulation / Multiple safety systems / Automatic cleaning system for the exchanger, burner basket and ash compactor / External and removable ashtray drawer / Hearth with vermiculite / Stainless steel burning pot / Including circulation pump, expansion valve and safety valve / Possibility to dismantle the hopper for installation.

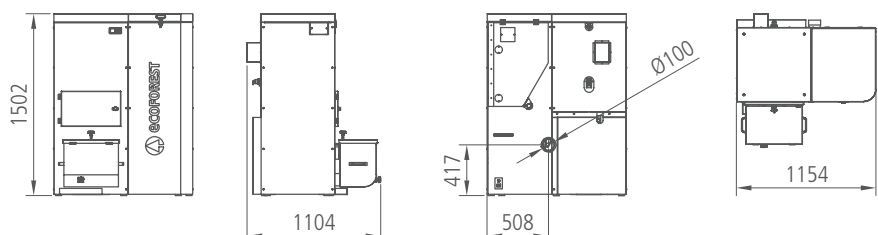

Vap 100



A++



WIFI
INTERNET
APP
INCL.



CARACTERÍSTICAS TÉCNICAS

Potência: 100 kW
Rendimento: 93 %
Depósito: Externo obrigatorio
Consumo: 6,2 - 21,5 kg/h
Autonomia: Según depósito externo
Peso: 1360 kg
Diâmetro saída de gases: 200 mm
EEI=131
Clase (UNE-EN 303-5:2013): 5

TECHNICAL SPECIFICATIONS

Power: 100 kW
Performance: 93 %
Hopper: Externe obligatoire
Consumption: 6,2 - 21,5 kg/h
Autonomy: According to external hopper
Weight: 1360 kg
Gas outlet diameter: 200 mm
EEI=131
Classe (UNE-EN 303-5:2013): 5

INCLUI

Controlo automático do fornecimento de ar de combustão, dos pellets e da bomba circuladora / Anti-condensação eletrónico (Regulação por software da temperatura de impulsão e do retorno sem válvula anti condensação) / Controlo de depósito A.Q.S. inércia e silos externos / Eletrónica exclusiva Ecoforest / Controlo e programação por potência ou por temperatura ambiente com modulação da potência / Múltiplos sistemas de segurança / Sistema de limpeza automático do intercambiador, cesto queimador e compactador das cinzas / Caixa de cinzas externa e extraível / Câmara de combustão reforçada em vermiculite / Cesto queimador em aço inoxidável / Inclui válvula de segurança / Possibilidade de desmontagem para instalação.

INCLUDING

Automatic control of combustion air, fuel supply and recirculating pump flow / Software regulation of flow and return temperatures without anti-condensation valve / Possibility to control DHW tank, buffer and hopper / Ecoforest exclusive electronics / Control and programming by power or by room temperature with power modulation / Multiple safety systems / Automatic cleaning system for the exchanger, burner basket and ash compactor / External and removable ashtray drawer / Hearth with vermiculite / Stainless steel burning pot / Safety valve included / Possibility to dismantle for installation.

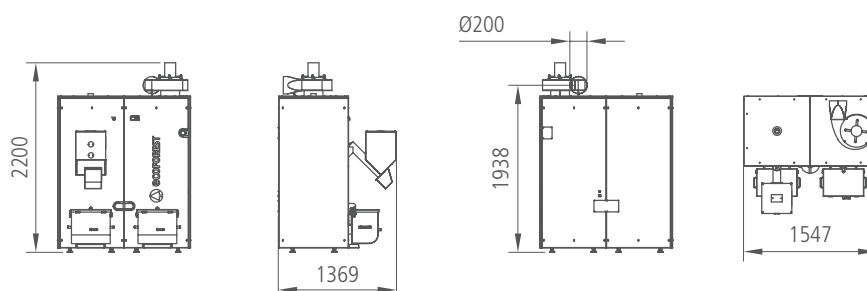





Lenha Wood



Ecoforest apresenta a sua gama de salamandras a lenha, concebidas para oferecer o máximo desempenho e conforto, com o máximo respeito pelo ambiente. Estas salamandras utilizam um combustível económico e ecológico: a madeira.

Ecoforest presents its range of wood stoves, designed to offer maximum performance and comfort, with maximum respect for the environment. These stoves use an economical and ecological fuel: wood.

Arlés



A



CARACTERÍSTICAS TÉCNICAS

Potência: 12 kW
Rendimento: 72 %
Consumo: 3,8 kg/h
Peso: 132 kg
Diâmetro saída de gases: 175 mm
EEI=94

TECHNICAL SPECIFICATIONS

Power: 12 kW
Performance: 72 %
Consumption: 3,8 kg/h
Weight: 132 kg
Gas outlet diameter: 175 mm
EEI=94

INCLUI

Câmara de combustão reforçada com cerâmica / Termostato para arranque automático do ventilador de ar / Gaveta das cinzas de grande capacidade / Sistema de limpeza por vácuo / Múltiplos sistemas de segurança / Ampla visão panorâmica do lume.

INCLUDING

Ceramic thermal insulated hearth / Automatic convector start by thermostat / Large capacity ashtray drawer / Vacuum cleaning system / Multiple safety systems / Panoramic view of fireplace.

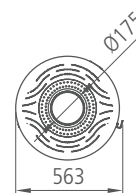
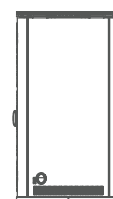
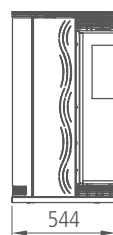
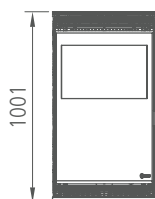

Eco Insert 90

Insert



A



CARACTERÍSTICAS TÉCNICAS

Potência: 14 kW
Rendimento: 72 %
Consumo: 4,5 kg/h
Peso: 158 kg
Diâmetro saída de gases: 200 mm
Diâmetro saída canalização de ar:
120 mm
EEI=94

TECHNICAL SPECIFICATIONS

Power: 14 kW
Performance: 72 %
Consumption: 4,5 kg/h
Weight: 158 kg
Gas outlet diameter: 200 mm
Ducted air outlet diameter:
120 mm
EEI=94

INCLUI

Câmara de combustão reforçada com cerâmica / Termostato para arranque automático do ventilador de ar / Gaveta das cinzas de grande capacidade / Sistema de limpeza por vácuo / Múltiplos sistemas de segurança / Possibilidade de canalização ar quente com motor auxiliar

INCLUDING

Ceramic thermal insulated hearth / Automatic convector start by thermostat / Large capacity ashtray drawer / Vacuum cleaning system / Multiple safety systems / Possibility of ducting with auxiliary motor.

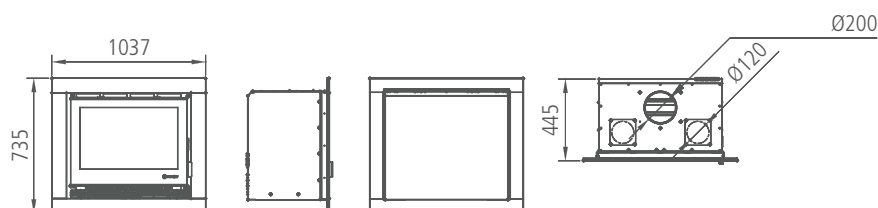

EcoGlass Insert 90

Insert



A



CARACTERÍSTICAS TÉCNICAS

Potência: 14 kW
Rendimento: 72 %
Consumo: 4,5 kg/h
Peso: 158 kg
Diâmetro saída de gases: 200 mm
Diâmetro saída de aire canalizable:
120 mm
EEI=94

TECHNICAL SPECIFICATIONS

Power: 14 kW
Performance: 72 %
Consumption: 4,5 kg/h
Weight: 158 kg
Gas outlet diameter: 200 mm
Diamètre sortie d'air canalisable:
120 mm
EEI=94

INCLUI

Câmara de combustão reforçada com cerâmica / Termostato para arranque automático do ventilador de ar / Gaveta das cinzas de grande capacidade / Sistema de limpeza por vácuo / Múltiplos sistemas de segurança / Possibilidade de canalização ar quente com motor auxiliar / Frente decorativa em vidro preto temperado.

INCLUDING

Ceramic thermal insulated hearth / Automatic convector start by thermostat / Large capacity ashtray drawer / Vacuum cleaning system / Multiple safety systems / Possibility of ducting with auxiliary motor / Front in black tempered glass.

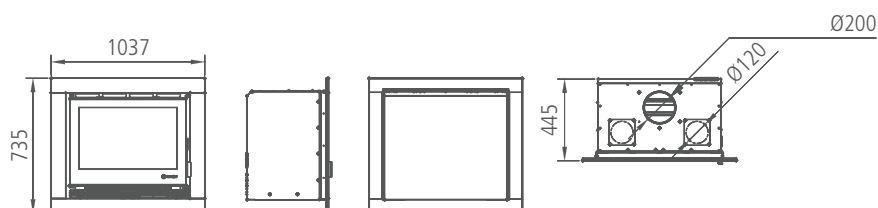

Moscú

Hydro



A



CARACTERÍSTICAS TÉCNICAS

Potência: 22 kW
Rendimento: 75 %
Consumo: 6,7 kg/h
Peso: 260 kg
Diâmetro saída de gases: 100 mm
EEI=99

TECHNICAL SPECIFICATIONS

Power: 22 kW
Performance: 75 %
Consumption: 6,7 kg/h
Weight: 260 kg
Gas outlet diameter: 100 mm
EEI=99

INCLUI

Regulação por software do caudal da bomba circuladora / Regulação por software da temperatura de impulsão e de retorno / Controlo eletrónico da combustão através da regulação de entrada do ar / Alto rendimento (tª saída de fumos=200°C) / Impulsão direta a radiadores / Câmara de combustão reforçada e intercâmbiador de calor perfeitamente isolado com lã de rocha que confere alta eficiência ao produto / Inclui bomba de alta eficiência e velocidade variável / Inclui válvula de segurança / Sistema de limpeza por vácuo.

INCLUDING

Software management of the circulator pump flow rate / Software regulation of flow and return temperatures / Electronic control of combustion by regulating the air in the hearth / High performance (Gas out temperature 200°C) / Direct flow to radiators / Combustion chamber and heat exchanger fully isolated with rock wool, giving high efficiency to the product / Including high efficiency pump with variable speed / Safety valve included / Vacuum cleaning system.

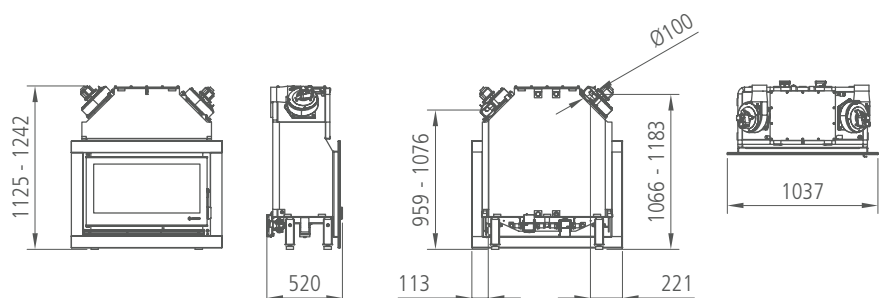



Caldeiras lenha

Wood boilers



A madeira é o combustível mais antigo utilizado para aquecimento. A Ecoforest utiliza este combustível renovável e neutro em CO₂ na sua gama de caldeiras a lenha. A nossa gama produz água quente doméstica, aquece os seus radiadores ou aquecimento por chão radiante em sua casa com o combustível mais tradicional.

Wood is the oldest fuel used for heating. Ecoforest uses this renewable and CO₂ neutral fuel in its range of wood boilers. Our range produces domestic hot water, heats your radiators or underfloor heating in your home with the most traditional fuel.

Madeira



A+



CARACTERÍSTICAS TÉCNICAS

Potência: 20 kW
Rendimento: 74,9 %
Peso: 251 kg
Diâmetro saída de gases: 150 mm
EEI=106

TECHNICAL SPECIFICATIONS

Power: 20 kW
Performance: 74,9 %
Weight: 251 kg
Gas outlet diameter: 150 mm
EEI=106

INCLUI

Corpo construído em aço de alta qualidade / Inclui "regulador de tiragem", que regula entrada de ar para combustão / Lavanca lateral para regulação mecânica da saída de fumos / Câmara de combustão reforçada e intercambiador de calor perfeitamente isolado com lã de rocha que confere alta eficiência ao produto / Grelha em fundição de fácil reposição na parte inferior da câmara de combustão / Inclui serpentina de segurança.

INCLUDING

High quality steel unit / Stove damper for combustion air regulation included / Side lever to mechanically regulate damper and vent included / Combustion chamber and heat exchanger fully isolated with rock wool, giving high efficiency to the product / Easy to replace cast grill in the lower part of the fireplace / Safety coil included.

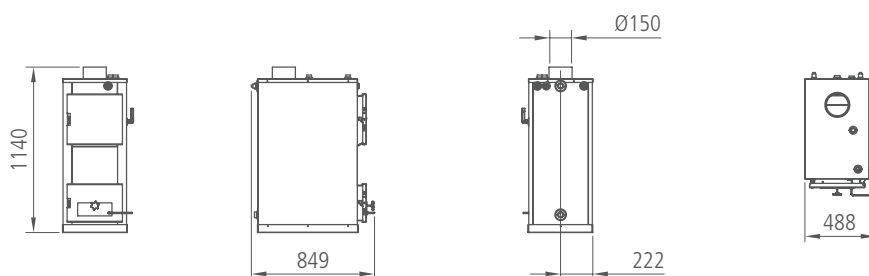

Fortaleza



A+



CARACTERÍSTICAS TÉCNICAS

Potência: 40 kW
Rendimento: 80 %
Peso: 325 kg
Diâmetro saída de gases: 100 mm
EEI=112

TECHNICAL SPECIFICATIONS

Power: 40 kW
Performance: 80 %
Weight: 325 kg
Gas outlet diameter: 100 mm
EEI=112

INCLUI

Regulação por software do caudal da bomba circuladora / Regulação por software da temperatura de impulsão e de retorno / Controlo eletrónico da combustão através da regulação de entrada do ar / Alto rendimento (tª saída de fumos=200°C) / Impulsão direta a radiadores / Câmara de combustão reforçada e intercâmbiador de calor perfeitamente isolado com lã de rocha que confere alta eficiência ao produto / Inclui bomba de alta eficiência e velocidade variável / Inclui válvula de segurança.

INCLUDING

Software management of the circulator pump flow rate / Software regulation of flow and return temperatures / Electronic control of combustion by regulating the air in the hearth / High performance (Gas out temperature 200°C) / Direct flow to radiators / Combustion chamber and heat exchanger fully isolated with rock wool, giving high efficiency to the product / Including high efficiency pump with variable speed / Safety valve included.

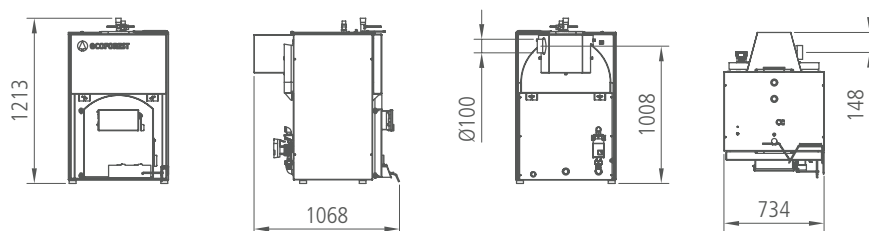



Depósitos de água

Tanks



Na Ecoforest procuramos conforto para os nossos clientes, por isso temos uma vasta gama de depósitos de AQS e depósitos de inércia de alta qualidade, especialmente concebidos para caldeiras VAP. Têm um elevado desempenho e um grande isolamento para reduzir ao mínimo as perdas de calor.

At Ecoforest we seek comfort for our customers, so we have a wide range of high quality DHW tanks and buffer tanks, specially designed for VAP boilers. They have a high exchange performance and great insulation to reduce heat losses to a minimum.

Depósitos de água / Tanks

AQS (MONTADO NA PAREDE, INSTALAÇÃO VERTICAL OU HORIZONTAL) /

DHW TANKS (WALL-MOUNTED, VERTICAL OR HORIZONTAL INSTALLATION)

Referência Reference	Designação Designation	Volume Volume	Potência absorvida Power	Diâmetro Diameter	Peso Weight	Altura Height
70007	ECO-A-IN-DEP-80-E	80 l	11 kW	440 mm	39 kg	1.004 mm
70008	ECO-A-IN-DEP-100-E	100 l	22 kW	520 mm	40 kg	883 mm
70009	ECO-A-IN-DEP-150-E	150 l	25 kW	520 mm	48 kg	1.133 mm

INCLUI

Versões de 80 a 150 litros vertical e horizontal montadas na parede / Depósitos de dupla câmara envolvente, câmara interna em aço inoxidável AISI 316 para AQS, P máx. 8 bar, e câmara externa em aço inoxidável AISI 304, P máx. 3 bar. / Temperatura máxima de trabalho 90°C / Pannel de controlo e resistência eléctrica / Isolamento térmico de espuma rígida de poliuretano injectado sem HCFC.

INCLUDING

Floor standing version from 80 to 150 litres / Double shell tank, inner shell in stainless steel AISI 316 for DHW, P max. 8 bar, and outer shell in stainless steel AISI 304, P max. 3 bar. / Max. working temperature 90°C / Control panel and electrical resistance / HCFC-free rigid injected polyurethane rigid foam thermal insulation.



AQS (INSTALAÇÃO VERTICAL NO SOLO) /

DHW TANKS (VERTICAL INSTALLATION ON THE GROUND)

Referência Reference	Designação Designation	Volume Volume	Potência absorvida Power	Diâmetro Diameter	Peso Weight	Altura Height
70010	ECO-A-IN-DES-80-E	80 l	11 kW	440 mm	39 kg	1.084 mm
70011	ECO-A-IN-DES-100-E	100 l	22 kW	520 mm	40 kg	963 mm
70012	ECO-A-IN-DES-150-E	150 l	25 kW	520 mm	48 kg	1.213 mm
70013	ECO-A-IN-DES-200-E	200 l	31 kW	520 mm	72 kg	1.513 mm

INCLUI

Versão de chão de 80 a 200 litros / Depósitos de dupla câmara envolvente, câmara interna em aço inoxidável AISI 316 para AQS, P máx. 8 bar, e câmara externa em aço inoxidável AISI 304, P máx. 3 bar. / Temperatura máxima de trabalho 90°C / Pannel de controlo e resistência eléctrica / Isolamento térmico de espuma rígida de poliuretano injectado sem HCFC.

INCLUDING

Floor standing version from 80 to 200 litres / Double shell tank, inner shell in stainless steel AISI 316 for DHW, P max. 8 bar, and outer shell in stainless steel AISI 304, P max. 3 bar. / Max. working temperature 90°C / Control panel and electrical resistance / HCFC-free rigid injected polyurethane rigid foam thermal insulation.



TANQUE DE SERPENTINA DE ACS ÚNICO / DHW TANKS

Referência Référence	Designación Designation	Volumen Volume	Diâmetro Diameter	Peso Weight	Altura Height
852G	T-DW 200	200 l	520 mm	47 kg	1.502 mm
851G	T-DW 300	300 l	560 mm	64 kg	1.866 mm
854G	T-DW 500	500 l	670 mm	84 kg	1.904 mm
855G	T-DW 750	750 l	930 mm	193 kg	1.815 mm
856G	T-DW 1000	1.000 l	930 mm	236 kg	2.055 mm



ECOTHERMO: BOMBA DE CALOR PARA PRODUÇÃO DE AQS /

ECOTHERMO: DHW HEAT PUMP

Referência Reference	Designação Designation	Volume Volume	Scop (14 °C) Scop (14 °C)	Peso Weight	Altura Height	Largura Depth
1062G	ecoTHERMO 200	200 l	3,1	80,5 kg	1.557 mm	585 mm
1063G	ecoTHERMO 260	260 l	3	105 kg	1.975 mm	585 mm

INCLUI

Bomba de calor ecoTHERMO para produção directa de AQS / Available in 200 and 260 litre capacity / Producción de agua caliente sanitaria hasta 70°C con resistencia eléctrica / Controlador táctil com 3 modos de operação.

INCLUDING

ecoTHERMO heat pump for direct DHW production / Available in 200 and 260 litres / Domestic hot water production up to 70°C with electrical heater / Touch-screen controller with 3 operating modes.



TANQUE DE INERCIA / BUFFER TANK

Referência Reference	Designação Designation	Volume Volume	Diâmetro Diameter	Peso Weight	Altura Height
853G	T-B 80	80 l	520 mm	31 kg	730 mm
859G	T-B 100	100 l	520 mm	45 kg	935 mm
857G	T-B 200	200 l	520 mm	69 kg	1.492 mm
858G	T-B 300	300 l	560 mm	106 kg	1.895 mm
863G	T-B 500	500 l	670 mm	128 kg	1.914 mm
864G	T-B 750	750 l	1.130 mm	171 kg	1.818 mm
860G	T-B 1000	1000 l	1.130 mm	212 kg	2.068 mm
861G	T-B 2000	2000 l	1.450 mm	364 kg	2.331 mm

INCLUI

Caixa de aço carbono (P máx. 3 bar) / Bobina solar (P máx. 6 bar) / Aquecimento com caldeira de biomassa / Temperatura máxima de trabalho 90°C / Isolamento térmico de espuma rígida de poliuretano injectado sem HCFC.

INCLUDING

Carbon steel case (P max. 3 bar) / Solar coil (P max. 6 bar) / Heating with biomass boiler / Max. working temperature 90°C / HCFC-free rigid injected polyurethane rigid foam thermal insulation.



TANK IN TANK / TANK IN TANK

Referência Reference	Designação Designation	Volume Volume	Diâmetro Diameter	Peso Weight	Altura Height
70001	ECO-I-500/150 IN-1S	150 / ACS 350 / inercia	670 mm	171 kg	1.904 mm
70002	ECO-I-750/200 IN-1S	200 / ACS 550 / inercia	930 mm	233 kg	1.815 mm
70003	ECO-I-1000/250 IN-1S	250 / ACS 750 / inercia	930 mm	261 kg	2.055 mm

INCLUI

Tanque em aço inoxidável ACS 316 (P máx. 8 bar) / Caixa de aço carbono (P máx. 3 bar) / Bobina solar (P máx. 6 bar) / Aquecimento com caldeira de biomassa / Temperatura máxima de trabalho 90°C / Isolamento térmico de espuma rígida de poliuretano injectado sem HCFC.

INCLUDING

ACS stainless steel 316 tank (P max. 8 bar) / Carbon steel enclosure (P max. 3 bar) / Solar coil (P max. 6 bar) / Heating with biomass boiler / Max. working temperature 90°C / HCFC-free rigid injected polyurethane rigid foam thermal insulation.



Silos e sistemas de alimentação

Silos and feeding system





Kit Silo

INCLUI

Silo
Sistema pneumático e mangueiras ¹
Boca de aspiração ²

INCLUDING

Silo
Pneumatic system and flexible flues ¹
Suction mouth ²

CARACTERÍSTICAS

O kit silo é vendido exclusivamente para a gama VAP / Os componentes do kit silo não são vendidos separadamente.

CHARACTERISTICS

Silo kits are only sold for the VAP range / Silo kit components are not sold individually.



Silo 350



Silo 620



Silo 900



Silo 2500



Silo 3400

Ecoforest declara que a capacidade indicada nos silos é orientativa, visto que depende do tipo de pellets utilizado. A capacidade pode variar mais ou menos 5 % Os modelos 2500 e 3400 incluem 1 acoplador Storz para reabastecimento de camião cisterna.

Ecoforest states that the capacity indicated on the silos is indicative as it depends on the type of pellets used. The capacity may vary plus or minus 5%. The 2500 et 3400 models include 1 Storz coupling piece for refilling with tanker truck.

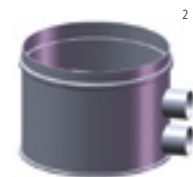

Referência Rererence	Designação Designation	Largura Width	Longo Long	Alto High
75050/2S	Kit Silo 350	100 cm	100 cm	130 cm
75039/2S	Kit Silo 620	130 cm	130 cm	130 cm
75040/2S	Kit Silo 900	120 cm	120 cm	200 cm
75042/2S	Kit Silo 2500	170 cm	170 cm	250-300 cm
75044/2S	Kit Silo 3400	200 cm	200 cm	250-300 cm

Consultar disponibilidade / Check availability.







www.ecoforest.com



A Ecoforest não assume qualquer responsabilidade pelos possíveis erros contidos neste documento, reservando-se o direito de realizar a qualquer momento e sem prévio aviso, as modificações que considerará adequadas por razões técnicas e comerciais. A disponibilidade de equipamentos será sempre confirmado pela Ecoforest. Sua apresentação neste documento não implica disponibilidade imediata dos mesmos.

Ecoforest declines all responsibility for possible errors contained in this document, reserving the right to make at any time and without prior notice the modifications deemed appropriate, for technical or commercial reasons. The availability of the equipment will always be confirmed by Ecoforest. The inclusion in this document does not mean the immediate availability of the equipment