



INDEX



NIGRAN PROJECT	5
E-DOMUS PROJECT	12
BATH ABBEY	20
ECOFORREST HEADQUARTERS	26
HOTEL VORAMAR PROJECT	34
ROCKS & HOTEL PROJECT	42
INDUSTRIAL ESTATE A GRANXA PROJECT	50
ZUGLIGETI LOVASUT PROJECT	58
WIMPOLE HALL PROJECT	65
CHILDREN'S SCHOOL EIMOS PROJECT	72
DONEGAL MILITARY CAMP	80
ALCORCON 42 SINGLE HOUSES PROJECT	86

Single house ecoSMART in Nigrán, all Ecoforest technology

NIGRÁN PROJECT

Single-family house with hybridization



Nigrán



On the edge of Nigrán, close to Ecoforest's new headquarters, lies this stylish, modern detached house. The owner of the house wanted to heat his home with the latest in renewable energy technology. To do this he decided to use a combination of Ecoforest heat pumps, with our own energy manager 'e-system' in order to take full advantage of the pre-existing photovoltaic panels. The objective was to reduce the electricity consumption of his home to a minimum, whilst also meeting his families heating needs, solely with green energy.

Inpoclima was brought in to take charge of the installation, due to their long successful history in the field of air conditioning and plumbing.

This installation is both interesting and unique because of the combination of photovoltaic energy used with the heat pump, to produce great results with almost zero power consumption.

Installation summary

Location:	Nigrán, Spain
Year:	2018
Installer:	Inpoclima
Type of installation:	Ground Source
Power:	1-9 kW
Services:	Heating, Cooling, DHW and Pool





Background

This detached house is newly built, making it perfectly suited for the latest technologies in both design and construction materials. At the same time, the most efficient solution possible was demanded for the air conditioning system, as the necessity of heating the pool also had to be taken into account.

The work was carried out at the end of 2017. Thanks to its great location, it was estimated that the photovoltaic installation would be able to almost fully support the heatpumps electricity needs due to the large number of hours of sunshine they get, being in such a prime location

Description of the system

The heat pump model installed was an ecoGEO C4 HTR EH heat pump with power of 1-9 kW. In combination with the heat pump, an e-system energy manager was installed with two battery modules for the thermal and electrical storage of the energy surplus generated by this installation.

As a collection system, only one well with a depth of 90 meters was used, significantly reducing the initial investment and taking advantage of the control strategies in the Ecoforest heat pumps, which allows the user to maximise use of the energy extracted from the ground.

The photovoltaic installation consists of 16 photovoltaic panels that represent a total of 4.8 kW installed.

Technical scheme of the installation



Real scheme of the installation

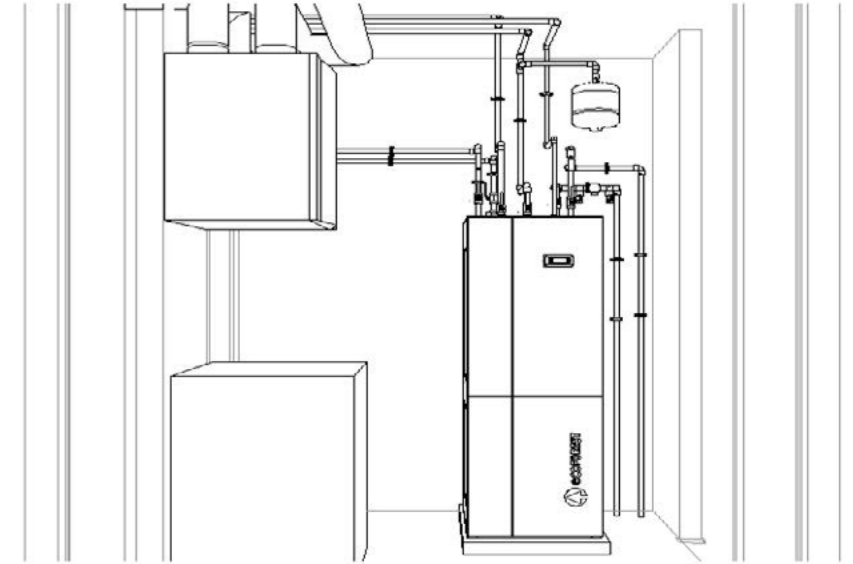

Real photos of the installation



Energy managers ecoSMART

The ecoSMART energy managers, combined with our own control strategies and software, convert our entire range of heat pumps into SG (smart grid) ready products.

Thanks to the great versatility provided by the high level of control, the modular capacity of Ecoforest heat pumps, the possibility of communication and finally the data transmission between the controllers, we've been able to design our own strategies. This means we have created the most efficient use for the energy produced through any type of renewable resource.

The ecoSMART energy managers allow thermal and electrical storage in addition to other functionalities. This technology is unique in Europe, being currently patented, controlling in the most efficient way the excess energy generated by your installation and the heat pump.



ZERO BALANCE BETWEEN PRODUCTION AND CONSUMPTION

Energy managers intelligently adjust if there is a surplus of energy in the system. Through a communications bus, the existence of any surplus is communicated to the heat pump, which then changes its consumption to take advantage of the surplus.

POWER LIMITATION

It's also possible to limit the power consumed by the installation with the heat pump. If the consumption level is close to the set limit, the heat pump will reduce its power consumption, so as not to exceed it.

TARIFF CONTROL

The energy managers allow users to establish schedules of the high and low electricity rates for the summer and winter periods. The heat pump will consume more energy when electricity is cheaper and reduce consumption when it is more expensive.

MANAGEMENT OF NON-CRITICAL LOADS

The energy managers allow relay outputs to feed up to five non-critical loads. These charges will only be activated in case of electrical surplus, the power and time are configurable. The deactivation of the same can be done by changing the level of consumption of the electrical network, through a timer or manually



Real data extracted from Easynet of heat pumps since installation

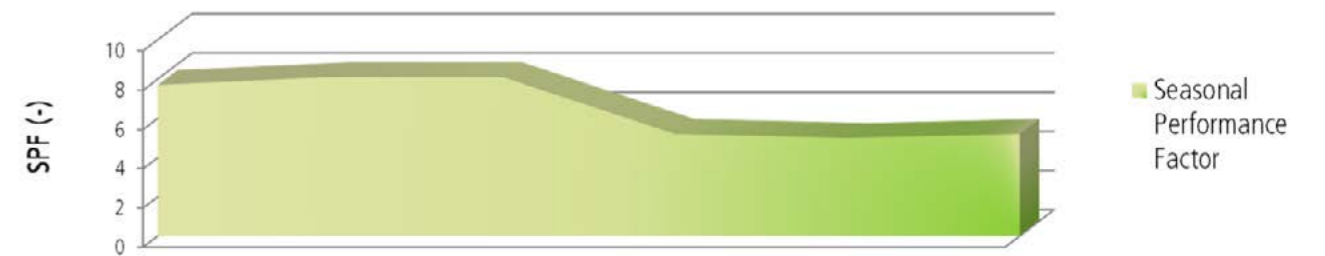
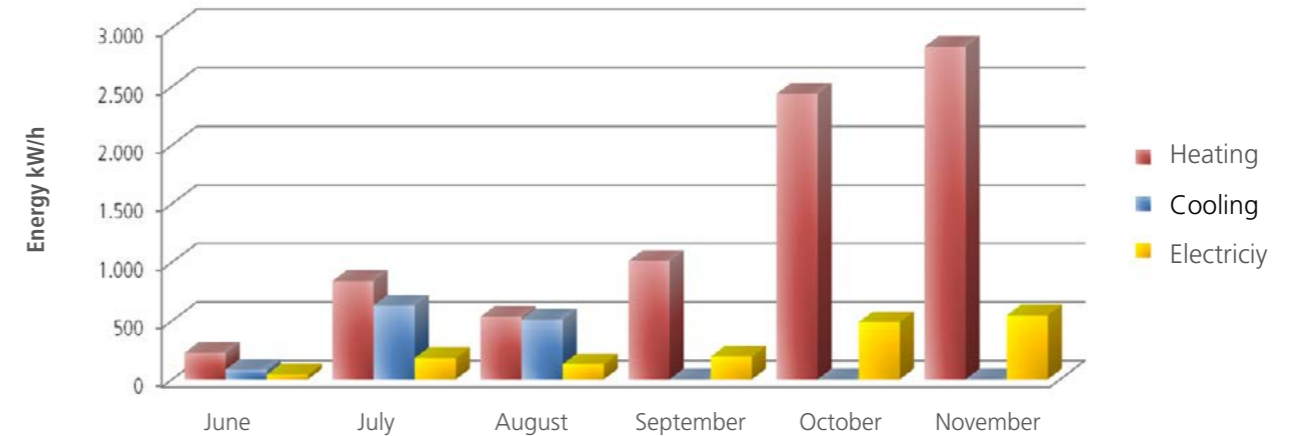

e-domus, your energy-efficient home

E-DOMUS PROJECT

63 single-family homes Boadilla del Monte



e-domus



E-domus has been a cooperative project managed by Hauser Gestion and designed by the architecture studio Carrillo Arquitectos I Forma y Espacio, led by the architect Jose Maria Carrillo Rodriguez who has formed a technical direction with the architect Juan Ramon Fanjul Morales

The work was carried out by the construction company Avintia Contrcciones y Proyectos, who chose to incorporate the latest ecoGEO ground source heat pumps into the installation. Thanks to our collaboration with Groen Energia Geotermica, who promoted and carried out the installation with our equipment, the end result was fantastic.

Installation summary

Location:	Boadilla del Monte, Spain
Year:	2017
Installer:	Groen
Type of installation:	Ground Source
Power:	63 x ecoGEO C4 3-12 HTR
Services:	Heating, Passive-Active Cooling and DHW





Background

The e-domus project is a new exclusive residential complex of 63 single-family houses, each with 3 or 4 bedrooms, and around 280 m², all located in the "La Cárcava" sector of Boadilla del Monte.

Avant-garde architecture in a gated and private community, equipped with a swimming pools, paddle tennis courts, recreation areas and landscaped spaces make this area quite desirable.

Heating, cooling and DHW all provided by a ground source collection array and distributed through underfloor heating with a non-polluting system of high energy efficiency and low consumption.



Description of the system

The approximate surface area to be heated in each of the homes is around 194 m². Each with energy demands of 10.47 kW in heating and 8.38 kW in cooling.

The geothermal collection field of each of the homes consists of 170 ml distributed in two 85.00 ml probes equipped with a 40 mm REHAU PE-RC simple probe.

The installed heat pump is an ecoGEO C4 3-12 HTR, capable of producing heating, passive and active cooling as well as domestic hot water at high temperatures.

▶ *Link video collection:*
www.youtube.com/embed/sCSCjPGstH8?rel=0&hd=1&wmode=Opaque

Technical scheme of the installation



Single-zone scheme with direct drive to underfloor heating.

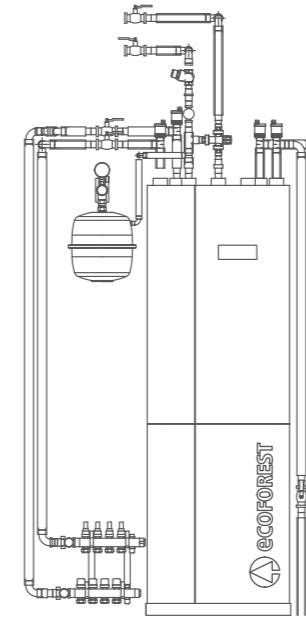

Real photos of the installation



Performances registered

Ecoforest heat pumps allow the user to monitor both the monthly and annual values of power, energy collected, energy produced, as well as the electrical consumption of the system. In addition to this, thanks to the Easynet tool they can be consulted remotely through any device with an Internet connection. Next, the simply spectacular results obtained after the installation of the heat pumps are presented, thanks among other things to our exclusive HTR technology that allows the simultaneous production of heating / cooling and DHW / pool.

Traditional heat pumps waste all the energy extracted from the house in the cooling process, transferring it to the ground (ground source) or to the ambient air (aeroterminia) (figure 1).

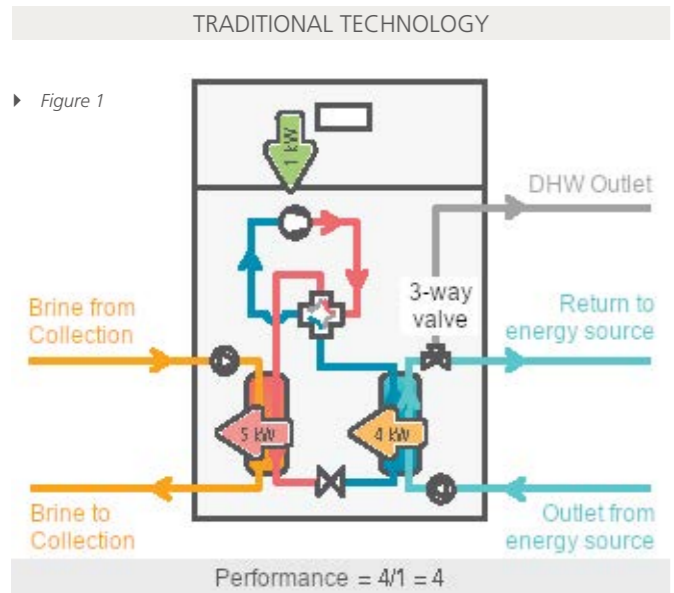

However, thanks to the HTR technology, this energy extracted from the home is used and reused for the either production of DHW or for the heating of a pool simultaneously, (figure 2) thus achieving previously unattainable levels of performance for any heat pump with conventional technology.

Furthermore, all this increases both the life of the heat pump and comfort in the home as a result of the consequent reduction in the number of cycle investments.

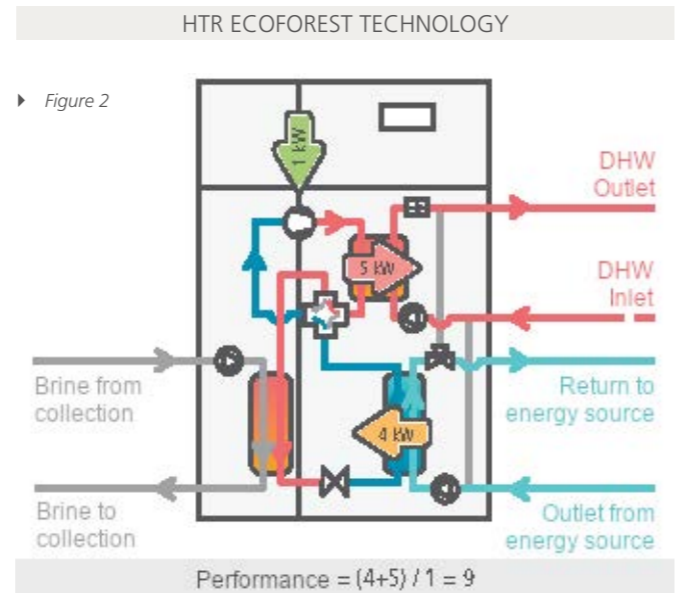

Real images of the energy meters included in the heat pumps installed in the e-domus project.



Links of interest

- E-domus efficient homes: e-domus.es
- E-domus project: www.carrilloarquitectos.com/project/e-domus
- Article in The World: www.elmundo.es
- Article in the Boadilla digital magazine and more: boadillaymas.es
- What is geothermal?: www.groen.es/que-es-la-geotermia.html
- Construction photos 2015-2017: www.carrilloarquitectos.com/project/e-domus
- Video realization geothermal probes e-domus project: www.youtube.com/embed/sCSCjPGstH8?rel=0&hd=1&wmode=Opaque
- Video Project e-domus: vimeo.com
- Video Construction 2017: vimeo.com



*Bath Abbey, a historic building heated by
renewable energies*

BATH ABBEY

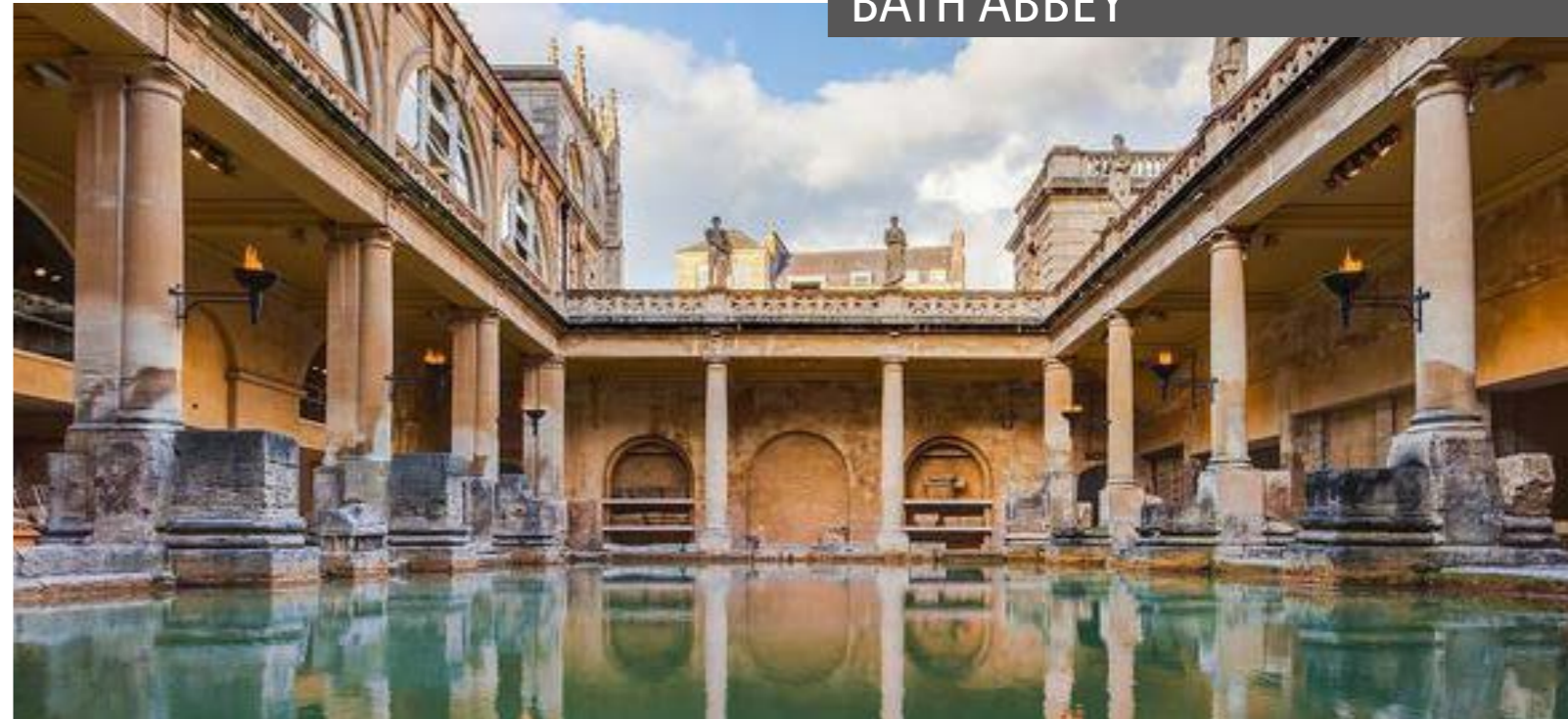

Bath Abbey ▼

As part of the Abbey's Footprint project, sections of the medieval church have been closed off to the public since May 2018 for essential repairs and restoration work to save the Abbey floor from collapse. At the same time, the historic floor is also being fitted throughout with an eco-friendly underfloor heating system that will eventually be fuelled using renewable energy generated by Bath's thermal water.

Every day, a quarter of a million gallons of hot water flow through the Roman Baths from the thermal spring located at the heart of the site. A large quantity of this hot water eventually ends up in the nearby River Avon via the Great Roman Drain. When harnessed and converted, it could potentially produce 1.5 megawatts of continuous energy to support a 200kW ground source heat pump system.

Installation summary

Location:	Bath, UK
Year:	2019
Installer:	ISOenergy
Type of installation:	Phreatic (ground water)
Power:	2x ecoGEO HP 25-100kW
Services:	Heating and DHW





Photographs of the installation



Background

The project is understood to be the first of its kind as it will source its energy for the ground source heat pump from the water that flows out of the Roman Baths in the centre of Bath.

Every day 1.1 million litres of hot water at approximately 37 degrees flows through the Roman Baths from underground springs. Most of it travels straight past the Abbey and into the river via a subterranean Roman drain.

The Abbey uses two 25-100kW HP ecGEO heatpumps

Description of the system

The heatpumps use "energy blades" to collect heat from the subterranean water.

All the pipework and fittings and EnergyBlades that are installed in the Great Drain are made from stainless steel to give the best protection against the harsh environment down there.

The blades used at Bath abbey were custom made due to restrictions in space, but also because of the high levels of temperature and corrosive elements.



Ecoforest headquarters, a prime example of sustainability and ecology within industry

ECOFORREST HEADQUARTERS



Ecoforest Headquarters ▼

One of the highlights of our 2018 was the opening of the new headquarters in Vigo. The new HQ houses our new production lines, a larger laboratory, a showroom and the ever expanding workforce.

Of course, being our headquarters, we wanted to put a special emphasis on the quality of the air conditioning system used, integrating a large part of the technology that we ourselves manufacture inside this building.

For this, the Technical Department of Ecoforest collaborated with other companies in the sector such as Inpoclima or Sogeman for the complete installation of the system. The results are astounding, if we do say so ourselves.

Installation summary

Location:	Vigo, Spain
Year:	2018
Installer:	Ecoforest Technical Team
Type of installation:	Freática
Power:	200 kW
Services:	Heating, active/passive cooling and DHW





Background

Ecoforest was founded in 1959 by José Carlos Alonso; His vision was to develop innovative products that are both economical and respectful of the environment, with the intention of making the world a better place.

Today, more than 50 years later, Ecoforest is the technological leader in the heating sector, with solutions based solely on clean and natural energy.

Thanks to the company's national and international growth in recent years, Ecoforest has again been forced to expand its facilities. This new building is a prime example of integration of several different technologies, sustainability and energy efficiency.

Description of the system

The energy system used in the Ecoforest heatquarters is unique for several reasons. We start with the catchment system, the heatpumps use the building's huge water tank as a system for capturing heat. The tank is around 700,000L, the temperature of the cistern is around 15°C all year round.

Additionally, the energy manager used (ecoSMART e-manager) connects the heat pumps to each other, but also with the photovoltaic panels on the roof. Any surplus generated by the 80 kW pv installation gets used by the heatpumps to generate free energy, instead of being sent back to the grid for deminished reward.

With just two compact machines, we are able to provide heating cooling, DHW and climate control for the office, factory and laboratory (over 14,000m² in total). The factory also has special ventilation/air-conditioning system, which runs free of charge when there is surplus from the photovoltaic panels.

Technical outline of the installation

► Cascade diagram of two ecoGEO heat pumps.

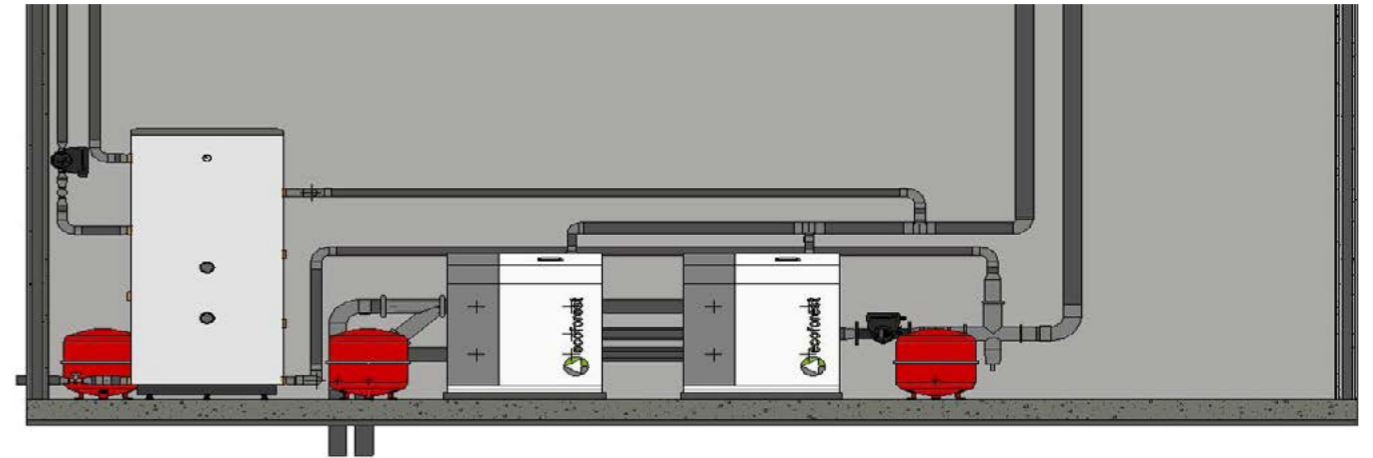

Photos taken from the HQ plantroom



Collection systems

The ecoGEO heat pumps are compatible with many different capture systems. Although traditionally associated with horizontal or vertical ground source intake, most systems can be used as an energy source for heat pumps.

The ecoGEO heat pumps have the added benefit of also being able to use aerothermal capture systems, using the AU air heaters available in sizes 12kW, 40kW, 70kW and 150kW. The ability to use airsource as a capture system also offers the possibility of combining both technologies, hybridizing the geothermal and aerothermal intake depending on the performance and the temperatures of each collection system.

As mentioned previously, phreatic catchment can also be used, taking advantage of the water resources that usually maintain temperature year round. The main benefit of using this type of capture is the economic savings gained by not having to assume the costs of drilling.

This installation at our HQ captures the energy directly from the cistern built to supply the fire-fighting installation, this cistern has a capacity of 730,000 liters, enough to supply the energy required to heat the building. This has saved a significant amount of money, eliminating the need for both wells boreholes, which were a mandatory feature when constructing in the area.

Finally, other types of special catchments that are also compatible or commonly used with ecoGEO heat pumps Energy Blades, (widely used in the UK), and thermoactive piles or Baskets, (especially interesting in Germany)

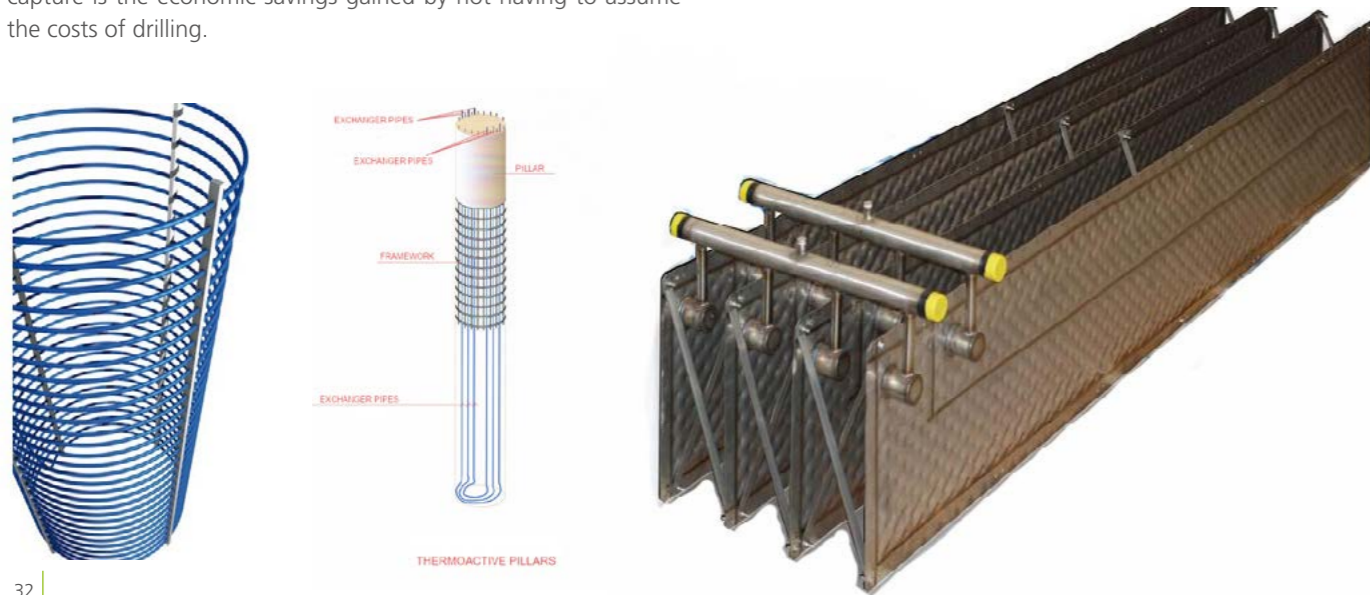

Real images of the energy meters included in the heat pumps.



The cascade time distribution system is simply spectacular.



Links of interest

- ▶ Nave Ecoforest Premio Aproin: <https://www.farodevigo.es>
- ▶ Ecoforest: <https://www.ecoforest.es>

Hotel Voramar, a five-star facility

HOTEL VORAMAR



Hotel Voramar▼

One of our partners, Itecon Ingeniería y Construcción lead the 'HVAC project' at Voramar Hotel, a picturesque hotel located close to the stunning Voramar beach in Benicasim.

The hotel was firmly committed to protecting the pristine natural environment, carrying out a rigorous sustainability plan in which their total energy needs could be met without great expense to the environment.

For this reason, the management of Hotel Voramar opted for the highly efficient HVAC system, in order to reduce energy consumption and minimize the environmental impact. Thanks to the good work carried out by Itecon, solar thermal and ground source energy were combined using Ecoforest heat pumps to produce the fantastic results.

Installation summary

Location:	Castellón, Spain
Year:	2016
Installer:	Itecon Ingeniería
Type of installation:	Ground Source
Power:	200 kW
Services:	Heating, Active cooling and DHW



Hotel Voramar, a five-star facility



Background

Below is a detailed description of the ground source system, which uses dynamic closed loop probes (DCL). The system was installed by Itecon SL at the Hotel Voramar located in the town of Benicassim (Castellón).

Description of the system

A cascading system was set up with a DCL ground source probe, which was connected to an evaporation / condensation circuit and two reversible ground source heat pumps. These provided heating, DHW and active cooling (positive/negative) for the entire hotel.

The system consists of:

- 5 boreholes for ground source, surrounding the perimeter of the building
- 5 DCL ground source probes placed in the 5 boreholes joined by

intake circuit conduits and electrical power lines, with controls and sensors in standardized trenches, leading to technical plant room.

- Two ecoGEO HP3 water-water heat pumps, ground source collection, with 100kW of nominal thermal power each. A total 200 kW for the complete HVAC (Heating, ventilation and Air conditioning) of the building.
- Hydraulic manifolds, an impulsion system and thermal fluid management in the technical plant room, all connected to the heat pumps and the ground array capture system.
- Integration of existing solar thermal system in facilities, with integral management of thermal energy and programming of its use in ACS.
- Control and monitoring system for thermal production facilities with total integration of the different subsystems.

Amazingly all this has been installed into the technical room of a new plant annexed to the building, including electrical power systems, electrical protection, ventilation, lighting and technical room security.

Technical scheme of the installation

- Cascade diagram of two ecoGEO heat pumps.



Real photos of the installation



Annual consumption

The system has consumed approximately 3,290 € worth of electricity, and has produced 155,206kWh of thermal energy. During this time in 2017, the price of energy was around 0,021 € per kWh.

A system of equivalent size, using AC's and diesel boilers (like the one that was replaced by the ground source heat pump) would have an annual consumption (with a lower calorific value of diesel of 9.98kW · h / liter and an EER for chillers of qualification C 2.1) of:

- Electricity: 40,672 kW · h
- Diesel fuel: 8,685 liters

The total cost would be € 5,084 in electricity and € 7,382 in diesel.

An annual saving of 9,176 euros, not counting the savings in maintenance or other factors.

There is an annual reduction of greenhouse gas emissions (According to values of emission factors of the IDAE) equivalent to 21,556kg of CO2.

The renewable system saves CO2 emissions equivalent to planting 10,000m² of pine trees, approximately 1,600 trees or annual emissions of 30 cars.

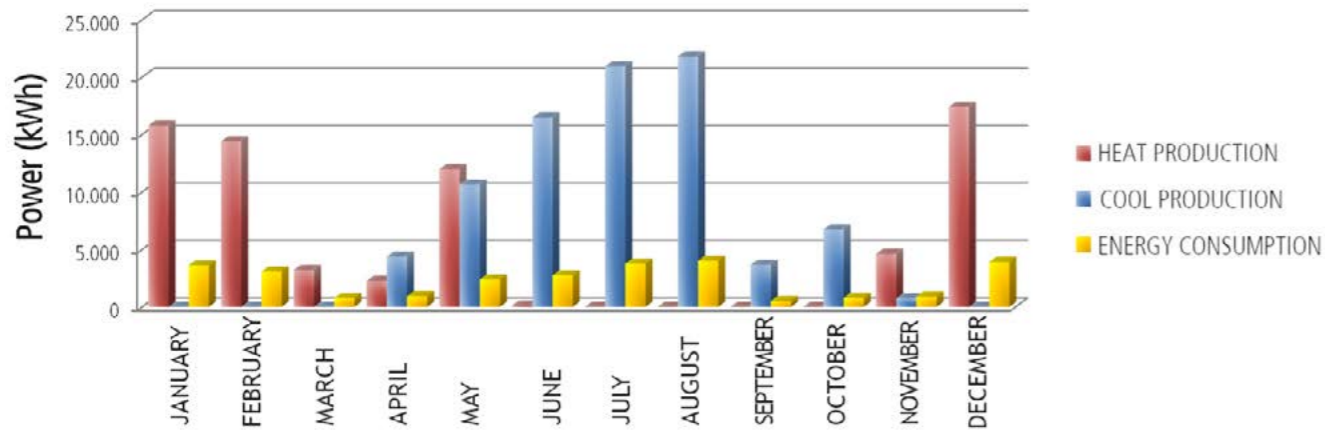

Real images of the energy meters included in the heat pumps installed in the Hotel Voramar.



Links of interest

- ▶ Hotel voramar: <http://www.voramar.net/>
- ▶ Itecon Servicios Energéticos: <http://www.itecon.es/es/>

Rocks & Hotel, a very playful installation



ROCKS HOTEL PROJECT

HVAC for a hotel complex

Rocks & Hotel Casino



In the city of Kyrenia, on the north coast of Cyprus, a high standing hotel is located at the Rocks Hotel & Casino.

Facilities include a casino, spa facilities and an outdoor pool. All this leads to a large energy consumption, especially with regards to air conditioning, taking into account the dimensions of the enclosure, plus the Spa area and the pool.

This problem led to the search for different solutions. Finally, the proposal sent by our partner Geotermia Engineering, using ecoGEO heat pumps, is chosen among all.

Installation summary

Location:	Girne, Cyprus
Year:	2018
Installer:	Geotermia Engineering
Type of installation:	Seawater / Airsource
Power:	1200 kW
Services:	Heating, Cooling, DHW, Pool and Spa





Background

After a change of ownership in 2016, an alternative was sought to reduce the energy costs of the Hotel Rocks & Casino. Due to its large surface and its large pool, around 750 cubic meters, a complete and efficient solution was needed for the total air conditioning of the installation.

Geothermia Engineering, official distributor of Ecoforest in Cyprus, had a similarly large project a few years prior, in that case it was a student residence, with a total power of 600 kW. Thanks to the experience acquired in that project, and to the great results achieved then, they were chosen for the make conduct this installation.



Description of the system

In the installation, a 1200 kW heating/cooling system was installed in the form of 12 ecoGEO HP1 25-100 kW heat pumps. The model used is the HP1 that allows the simultaneous production of heating and cooling, something only possible thanks to the Ecoforest technology.

The catchment system used is particularly curious since geothermal wells are not used to obtain energy. A part of the collection system is in the sea..

The collection is completed with six air heaters of more than 100kW. The combination between marine and aérothermal capture is only made possible thanks to the e-source, an exclusive product developed by Ecoforest.n

Technical scheme of the installation

► Real scheme of the installation

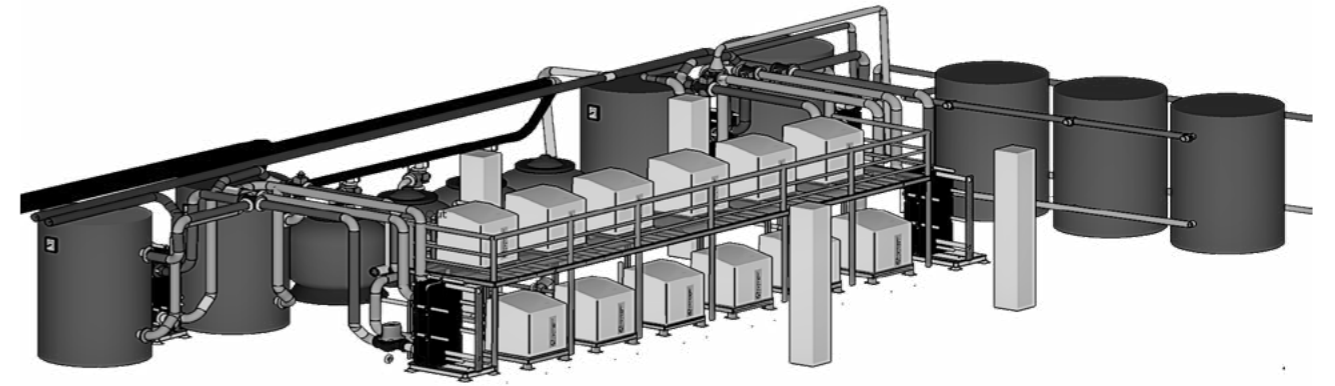

Real photos of the installation

►



The energy manager, e-source

The ecoSMART e-source source manager is an electronic controller designed to manage several sources of energy simultaneously.

It can work with a single ecoGEO HP heat pump or with a cascade of several HP ecoGEO heat pumps controlled by a supervisor ecoSMART. To do this, you must establish pLAN bus communication with the heat pump or the heat pump cascade.

E-source functionalities include:

- Management of up to four independent collection sources
- Management of defrosting of aerothermal sources

Advantages of e-source:

- Reduction of costs associated with drilling
- Possibility to utilize hybrid installations
- Opens up possibilities where drilling limitations have previously prevented new installations
- Defrosting aerothermal sources (without stopping the compressor).
- All the advantages of ecoGEO HP geothermal pumps with aerothermal source



With e-source, combining different capture systems to create unique installations is simple and effective. Furthermore, with access to the Internet through the Easynet and the Supervisor (cascade manager), the e-source can create some of the most versatile installations on the market.



Real data extracted from Easynet of heat pumps since installation

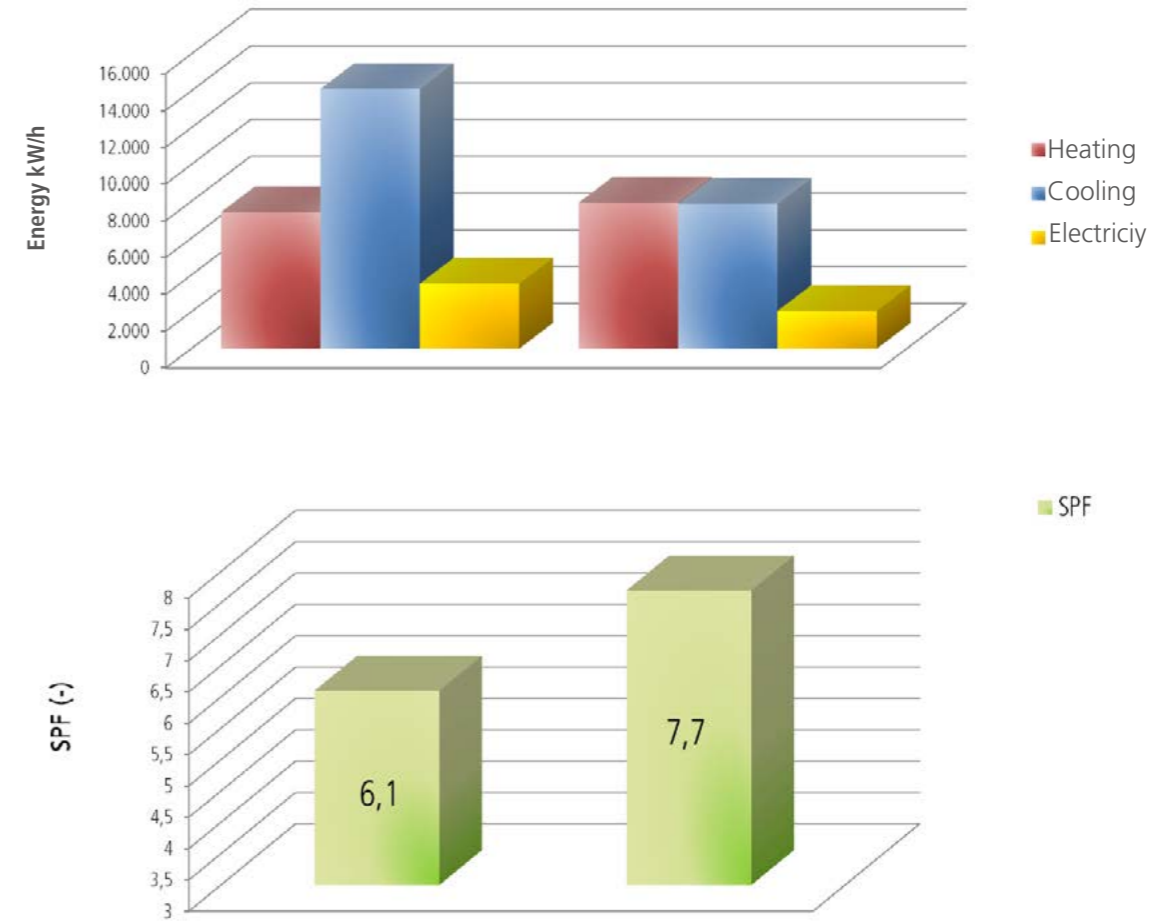

Polígono A Granxa, efficiency in industry

A GRANXA INDUSTRIAL AREA

Centralized installation for several buildings



Polígono "A Granxa"



In July 2017, a 270 kW ground source installation was carried out in the A Granxa using 3 ecoGEO HP3 (High Power) heat pumps.

At the time of completion, it was the largest ever ground source installation the entire Galician region.

This project included a complete ground source system for the central buildings of the A Granxa Business Park. In order to achieve this feat, several different Galician companies had to collaborate, such as the construction company Civis Global, the engineering firm Viser Ingeniería Integral, the installation company Energanova, the Galaicontrol surveyors and of course the partnership between the Zona Franca consortium and Ecoforest .

Installation summary

Location:	Industrial Area A Granxa, Pontevedra, Spain
Year:	2017
Installer:	Energanova
Type of installation:	Ground Source
Power:	270 kW
Services:	Heating, Active Cooling and DHW

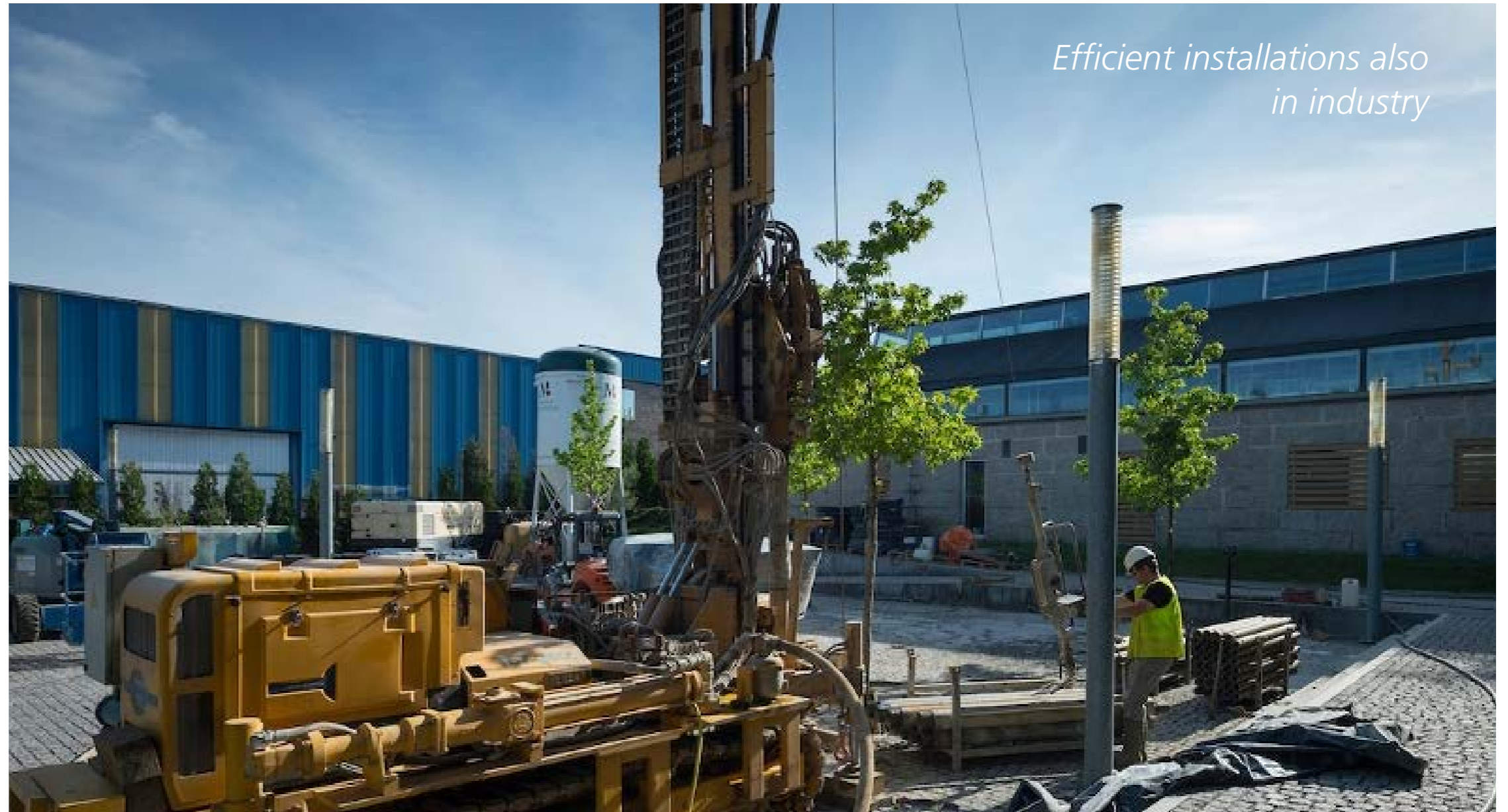

*Efficient installations also
in industry*



Background

The industrial estate of A Granxa, located in Porriño (Pontevedra) has been operating since 1996. It encompasses all the industrial land created by the Zona Franca de Vigo Consortium.

It has a total area of 933,149 m², among which you can find plots for companies, road systems, green areas, sports and social equipment/centres.

It is located in a strategically desirable area, a few kilometers from Portugal (to the south) and the city of Vigo (to the north). The main sectors of activities in the existing industrial area are the auxiliary automotive sector, the ornamental stone sector and the transport and logistics sector.



Description of the system

The client requested a complete ground source energy system in the central buildings of the A Granxa Business Park.

The installation consisted of three cascading ecoGEO HP3 heat pumps, which provide a total of 270 kW for all the heating, cooling and domestic hot water of the facility. All of this was possible thanks to a vertical collection array which was placed in 24 boreholes, each with a depth of 140 meters. In total, more than 3.5 kilometers of pipes are available to drive the fluid.

There are five different drive groups in the facility (Office Zone, Fancoils North and South Zone, Cafeteria and the Casa da Pedra Annex Building). The impulse collector is connected to a 750-liter hot and cold storage tank.

Technical scheme of the installation

- Scheme in cascade with three ecoGEO heat pumps connected to an inertial tank and in turn to 5 groups of impulsion.

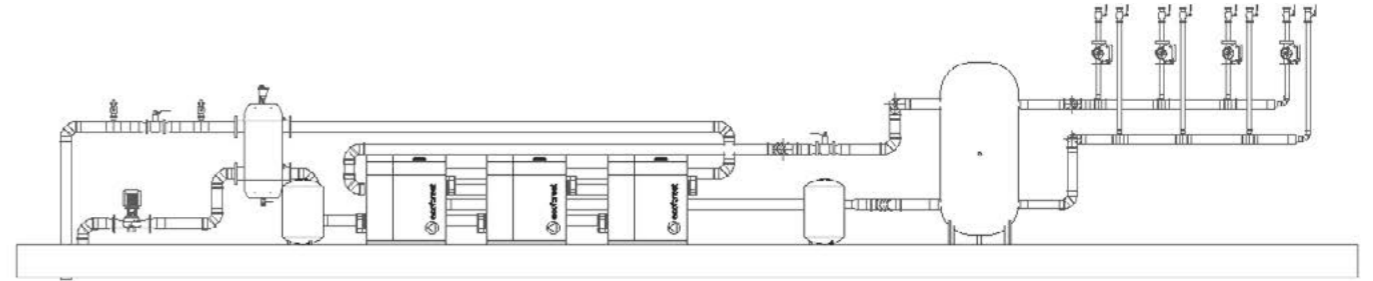

Real photos of the installation



The advantages of Ecoforest technology

Right from the start, Ecoforest understood that ground source heat pumps were the future of the heating & cooling industry. For this reason, we strove to modernize and innovate wherever we could. We were the first manufacturer of ground source heat pumps to include both inverter compressors and active cooling cycle inversion in the

► **INVERTER TECHNOLOGY and ECOFOREST SOFTWARE:**

The R&D team at Ecoforest is constantly developing new and effective software for all the machines we produce, developing specially designed controls for our entire range of heat pumps. Thanks to these constant improvements, ecoGEO heat pumps are able to modulate the power from 25% to 100% providing unsurpassed performance and making our heat pumps the best in the market.

Some of the additional advantages ecoforest heatpumps have over traditional heat pumps include:

- More compact and economic facilities.
- Less electrical consumption.
- Greater durability and reliability.

► **DANFOSS SCROLL COMPRESSOR**

Specially designed to utilize the inverter technology, ecoGEO heat pumps incorporate a modulating Scroll compressor, which offers several advantages over traditional rotary compressors such as a longer life, higher efficiency and a lower noise level.

► **CASCADE UP TO 600 kW**

With the ecoGEO's, it's not only possible to cascade up to 600kW, but also micromanage the entire system, following the efficiency of each individual unit, and allowing them to modulate at all times, so as to maximise efficiency. Allowing the user to distribute the workload as they see fit.



► **ACTIVE COOLING BY INVERSION THE CYCLE:**

The incorporation of the 4-way valve allows heating and cooling to be carried out with the same equipment, negating the need to install any additional external modules. External modules can often reduce efficiency, increase the cost of installation and the cost of maintenance.

In addition to this, our extensive experience in the production of cooling, which is in many ways more difficult than the production of heating, has allowed us to develop one of the safest and most reliable heat pumps on the market.

One example of a way we have improved the safety is by adding antifreeze protection on the exchangers, for security against condensation on the circuits.

Registered returns

Another company which we collaborated with on the A Granxa project is ACELEC Instalaciones Eléctricas S.L. ACELEC was in charge of replacing and reforming electrical controls, protection panels, power supply lines and control of the equipment that make up the installation.

Thanks to the installed monitoring system, both the temperature of the circulating pumps from the boreholes and production can be seen at any moment, in flow and in return. The same is possible with the temperatures and pressures of the compressor, obtaining information at any moment from the values both for aspiration and discharge of the same.

Finally, the hours of operation for heating, cooling and the electrical consumption derived from heat pumps through the same application can also be measured.

The results have been nothing short of spectacular. After the installation of the ecoGEO heat pumps, the electric bill has been reduced by over half, and in addition to heating, the cooling which was previously carried out by a dedicated chiller is now also done by the heatpumps, saving even more money and energy. **The current SPF (Seasonal Performance Factor) of the installation since the opening of the installation is 5.55.**

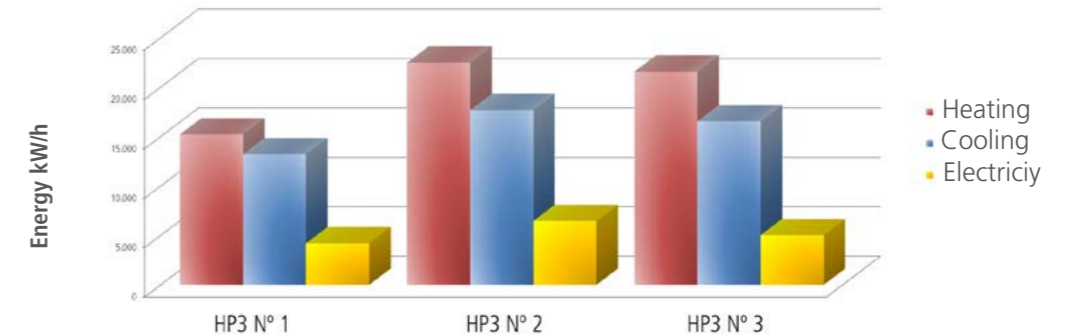

Links of interest

- Geothermal HVAC - Polígono de A Granxa (O Porriño): www.civisglobal.com
- Works carried out - Acelec Instalaciones Eléctricas: www.acelec.es

Zugligeti Lóvasut, an installation with history

ZUGLIGETI LÓVASÚT PROJECT

Museum and concert hall in Budapest



Zugligeti Lóvasút



The Zugligeti Lóvasút building is a gorgeous establishment rich with history situated in the heart of Hungary. The building is a reconstruction of the old railway station in Zugliget, which was the final train station for horses in Hungary. The structure was refurbished in 2016 with the support of the Hungarian government, the EGF, and the Hegyvidéki Önkormányzat. It was reopened to the public on 17th of September 2017.

The company Smartcool Kft, who are the official distributor of Ecoforest in Hungary, carried out the entire HVAC project.

However, Geoconcept also deserves credit as the company in charge of carrying out the system of capture of the heat pumps.

Installation summary

Location:	Budapest, Hungary
Year:	2017
Installer:	Smartcool-Geoconcept
Type of installation:	Ground Source
Power:	110 kW
Services:	Heating, Active-Passive Cooling and DHW



Zugligeti Lóvasút, an installation with history

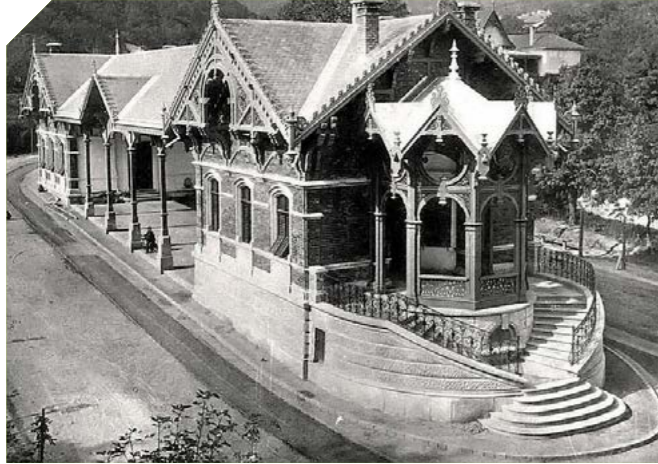

Background

The construction of this building dates back to the late nineteenth century, initially it was a railway station on horseback (the final ever built in Hungary). Later however it would end up becoming a simple stop, that included general services such as a post office. Finally, in 1977 it was abandoned and fell into dilapidation.

Finally after several failed attempts, a reconstruction project was approved and the building saw new life as museum with a cafeteria and restaurant.

Description of the system

To provide a full service to this building, two high power Ecoforest ground source heat pumps were installed:

- ecoGEO HP1 12-40 kW and ecoGEO HP 3 15-70 kW.

Description of the system

The ecoGEO HP1 ground source heat pump is used for the production of domestic hot water and heating, while the ecoGEO HP3 is also used for cooling.

A passive cooling exchanger was installed, which is managed by the ecoGEO HP1 12-40 heat pump to cool the collection area and recover the energy from the boreholes during the summer. In this way it could be said that active cooling and passive cooling are being produced simultaneously. This is possible thanks to the technology of Ecoforest heat pumps that allow great versatility.

The catchment is a ground source system consisting of a total of 24 boreholes made by vertical drilling. Due to the location and the terrain, the maximum extension of these boreholes is 80 meters each, which means a total of 1920 meters drilled around the surface of the building.

The system is a perfect example of high end refurbishment with a strong commitment to the environment. High yields and a zero visual impact are achieved to the benefit of everyone.

Technical scheme of the installation

► Real scheme of the installation

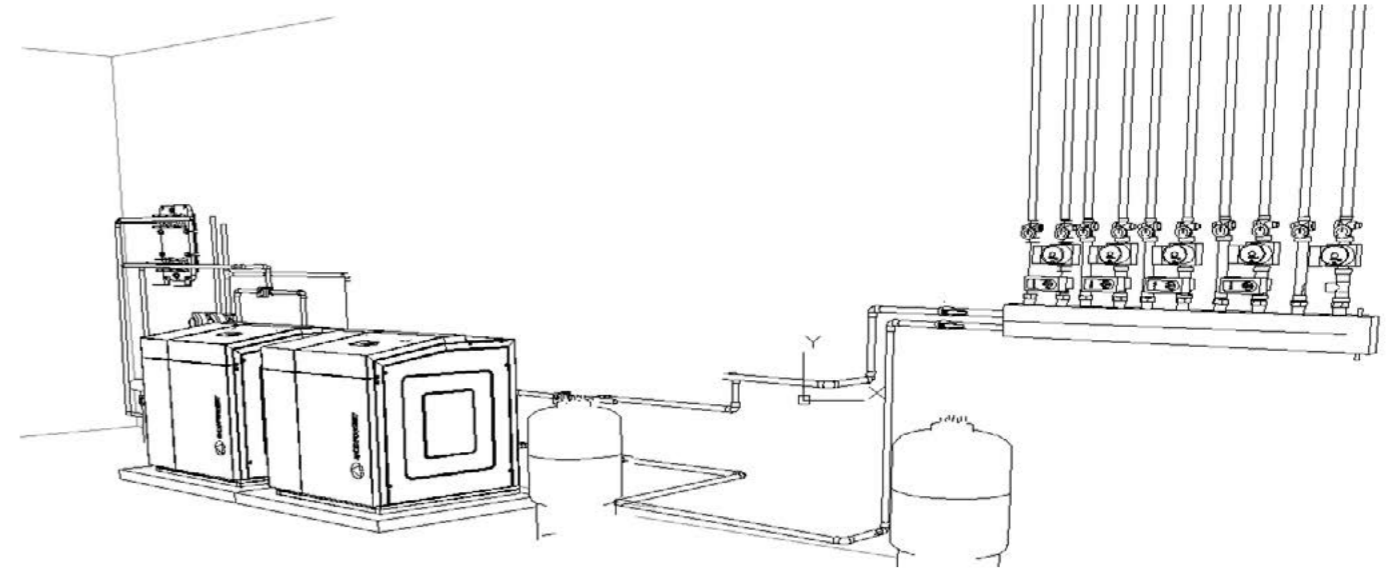

Real photos of the installation

►



Why use heat pumps with Inverter?

In traditional heat pumps (ON-OFF) the Seasonal Performance Coefficient (SPF) decreases significantly because the heat pump can not adapt to variations in demand, and the heat pump drive temperature needs to be higher .

- It is impossible to set the outlet temperature (the higher the inlet temperature, the higher the exit temperature) -> Buffer Tank -> Lower efficiency (maximum COP only in the lower part).

- It is necessary to install a buffer tank and at least one additional shunt group, which considerably increases the cost and complexity of the installation.

- In addition, the buffer tanks represents a loss of efficiency throughout the year, since it has energy losses exchanging into the environment.

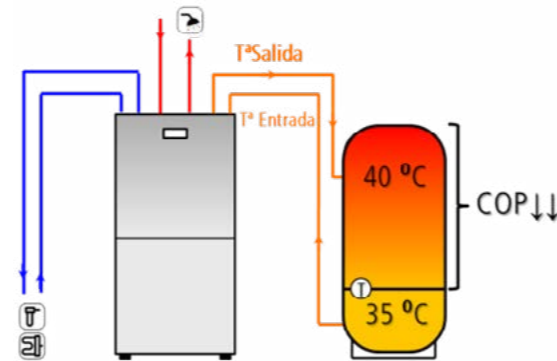

SAVINGS



With inverter technology, energy savings of up to 40% can be achieved, depending on usage, by regulating the operating frequency of the compressor.

MORE SILENT



By avoiding continuous ON / OFF starts, the compressor and fan operate at low speeds, considerably reducing the noise level.

ENERGY EFFICIENCY



Adaptation to consumption always within the comfort range.

DURABILITY



By avoiding the continuous ON / OFF starts, the device has to make less effort therefore, it will extend its life considerably.

COMFORT



The temperature remains stable without sudden changes, which guarantees greater comfort. Increased comfort in the underfloor heating when working with a temperature jump.



Real data extracted from Easynet of heat pumps since installation

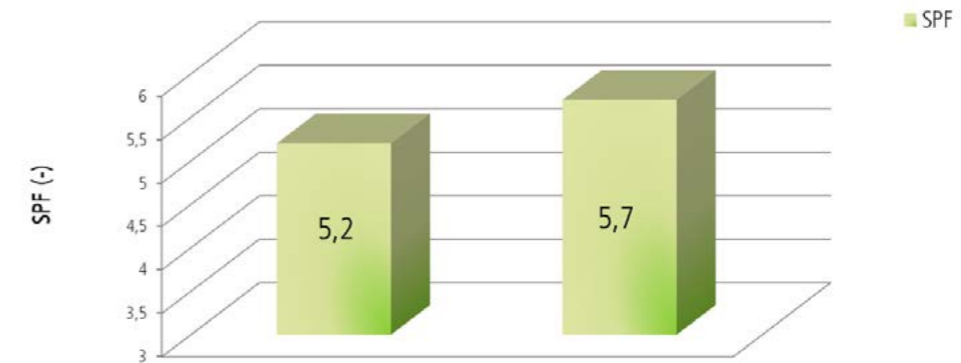
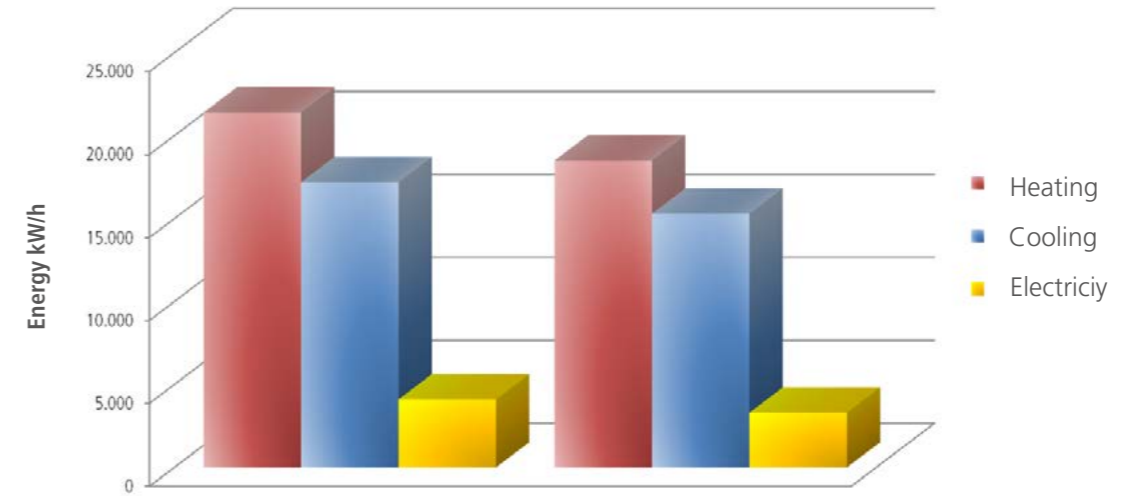

Wimpole Hall, a National Trust installation



WIMPOLE HALL PROJECT

National Trust installation

Wimpole Hall



National Trust chose ISOenergy for the difficult task of modernizing the heating systems of the Wimpole Hall building.

The large seasonal changes, combined with the large surface areas and the general lack of insulation make heating a building of these characteristics very complicated. In the past, the solution has been simply to use large amounts of fuel to maintain the interior temperature. However, due to the increase in the price of oil and the need to be more respectful of the environment, National Trust decided that it was time for a change.

ISOenergy chose Ecoforest heat pumps for this purpose, thanks to the success accumulated in other facilities.

Installation summary

Location:	Wimpole, UK
Year:	2018
Installer:	ISOenergy
Type of installation:	Ground Source
Power:	180 kW
Services:	Heating and DHW





Background

Wimpole Hall is the largest building in Cambridgeshire, England and consists of a main mansion and several annex buildings.

The main mansion was built in 1640 and was originally owned by the Chicheley family. Throughout the centuries, it was a busy place, with numerous dinners and events that were attended by Queen Victoria.

In 1976, a National Trust building was demoted, after the transfer by Mrs. Elsie Bambridge before her death. It is currently a space open to the public where events and visits are held.



Description of the system

Because of the large scale of this job, the national trust actually required two different installations, first a cascade of two ecoGEO heat pumps 15-70kW which were installed in the main mansion.

Additionally an installation was made in the restaurant attached to this building. In this case an ecoGEO HP1 of 12-40 kW, accumulating a total of 180 kW in the installation of Wimpole Hall and its annexes.

The collection system used for this installation is made up of a total of 30 geothermal wells of 125 meters each, located in the parking area.

Technical scheme of the installation

► Real scheme of the installation



Real photos of the installation



*Eimos school, from the beginning committed
to efficiency*

EIMOS SCHOOL PROJECT

Low consumption school in Mos



Eimos School



The new pre-school located in Mos uses geometry and natural occurring themes to encompass all its students. The long fragmented roof strips allow light to pour in the south side, providing the building with an abundance of natural light in all interior spaces.

Well lit and ventilated, it's a building in which children can enjoy nature protected by the outer circle and completely disconnected from the industrial estate.

All the classrooms are oriented to the South and have direct access to the outdoor leisure area.

The project was led by Estefanía Grandal (Encaixe Arquitectura y Ingeniería), Faustino Patiño and Juan Prieto.

The work has been executed by the construction company Misturas, for the network of infant schools of the Xunta de Galicia, Galiña Azul.

Installation summary

Location:	Mos, Pontevedra
Year:	2017
Installer:	Encaixe Arquitectura e Ingeniería
Type of installation:	Air Source
Power:	AU12 + ecoGEO B2 5-22 EH
Services:	Heating and DHW



*Eimos School, from the beginning
committed to efficiency*



Background

To continue the nature trend, the facilities will use renewable energy generation systems as well as passive architecture concepts, trying to adapt the design of the building to sustainability standards. The project aims to create a quality interior space in which students and teachers can develop and enjoy the learning process, a fundamental activity at such an early age.

The nursery school has 82 places divided into 6 classrooms for ages 0-1, 1-2 and 2-3.



Description of the system

The total surface area which needed to be heated was 550 m², with energy demands of 15 kW in heating.

The heat is captured by an Ecoforest AU12 air heater, which has been placed within the schools walls, in order to avoid disrupting the visual symmetry.

The installed heat pump is an ecoGEO B2T 5-22 EH, capable of producing heating and domestic hot water at high temperatures.

In addition, the team manages legionella control and DHW recirculation.

Technical scheme of the installation

Single-zone diagram with direct drive to radiant floor and 3D of thermal installations and ventilation ▼

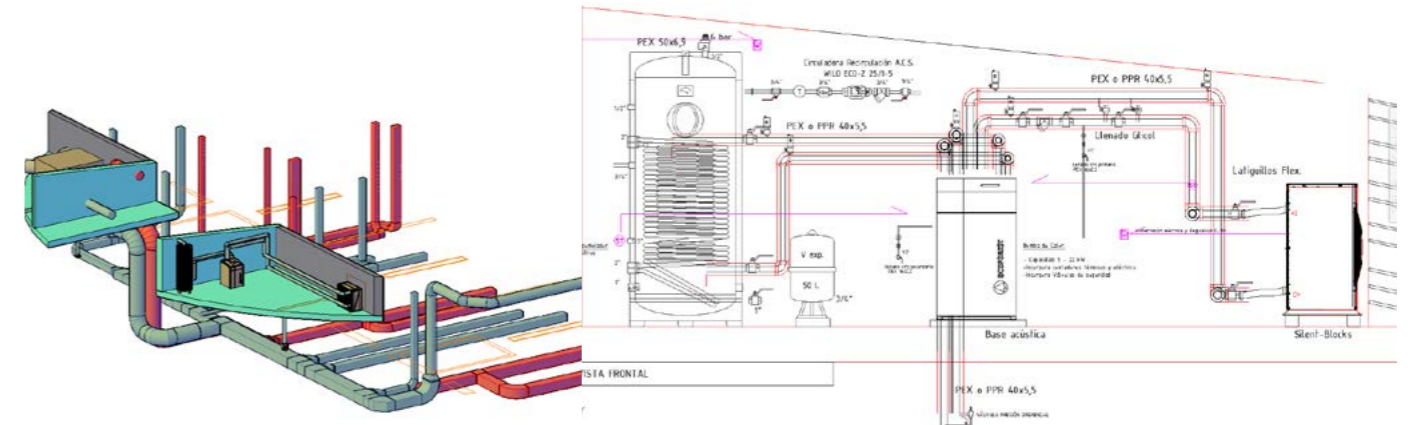

Real photos of the installation

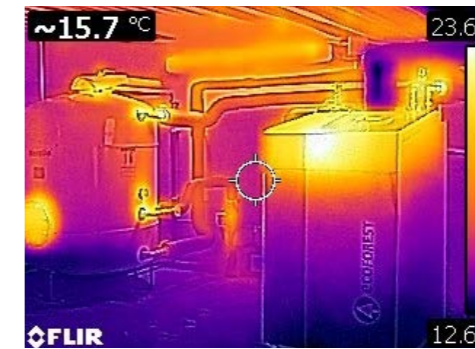

Performance returns

Ecoforest heat pumps allow the user to monitor both the monthly and annual values of power, along with the amount of energy captured and produced. The electrical consumption of the system are also recorded in it.

The defrosting technique for the ecoGEO is both unique and efficient (figure 2): the compressor stops during the defrost cycle, the energy source is selected for the defrost cycle (either from heating, DHW or pool) and through an internal heat exchanger (A) the defrost is a completely hydraulic cycle. This has the effect of considerably increasing of the seasonal performance (SPF), reduces the power consumption and significantly reducing the defrosting time.

Because the compressor does not have to invest energy into reversing its cycle (like the current technology, figure 1), both lifespan of the heat pump and the comfort in the home are increased as a consequence of the reduction in the number of cycle investments.

All this means that with the modulation of the ecoGEO, December (one of the coldest months together with January and February in this region) has a monthly SPF of more than 5, as can be seen on the next page.

TRADITIONAL TECHNOLOGY

ECOFREST DEFROSTING TECHNOLOGY

► Figure 1

► Figure 2



Imagen real de los contadores de energía incluidos en la bomba de calor ecoGEO



Military camp in Donegal, aerothermics to combat the cold

MILITARY CAMP

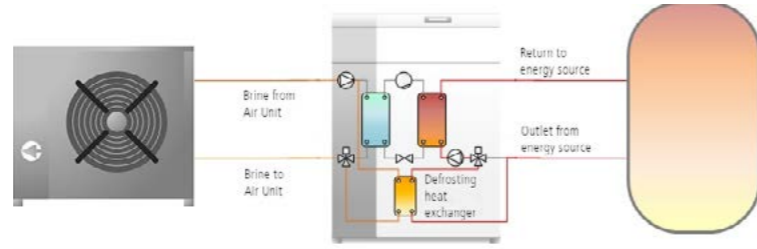
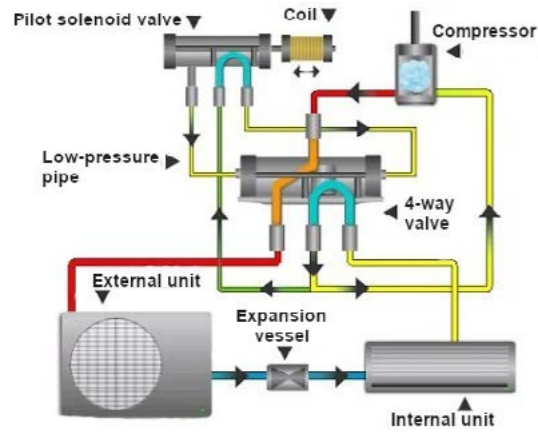
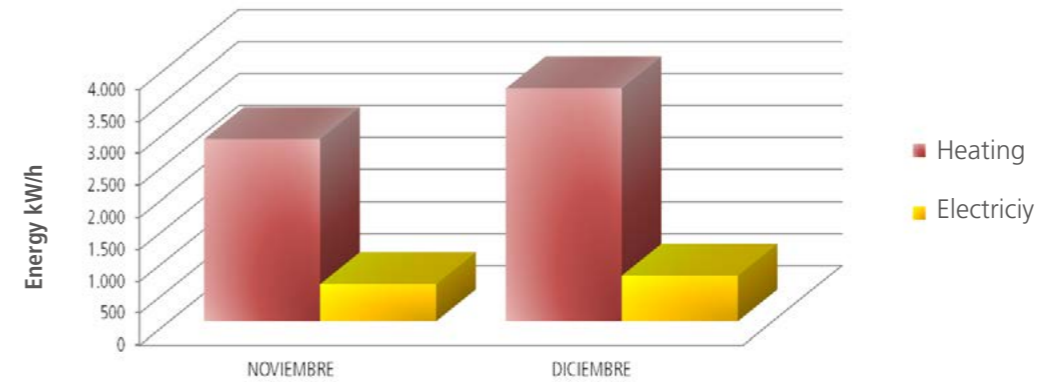
5 Irish Army barracks

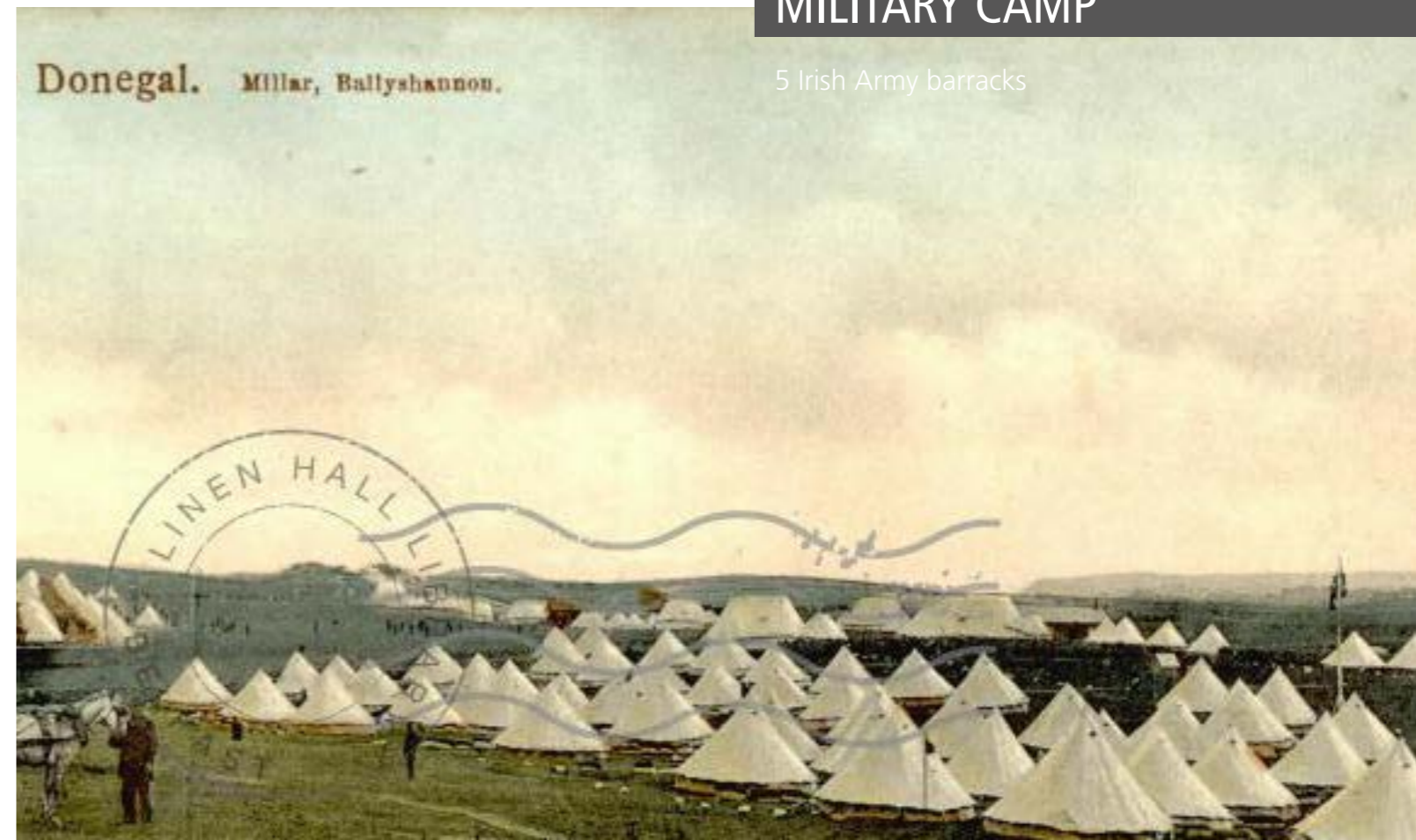

Military camp ▼

In the Donegal military camp, the rehabilitation of the five barracks where the Irish army sleeps located in this cold region of Ireland has been carried out.

The Irish Army was looking for a unique solution that could be replicated in all its locations, respecting the environment and making it sustainable over time.

Thanks to the work of the Ecoforest Technical Office and Efficient Renewables, they now enjoy warmth and comfort thanks to the ecoAIR EVI 4-20 kW.



Installation summary

Location:	Donegal, Ireland
Año:	2020
Installator:	Efficient Renewables
Type of installation:	Aerothermal
Power:	5 x ecoAIR EVI 4-20 kW
Services:	Heating and DHW



Background

Finner Camp, a military installation near Ballyshannon in Ireland. The barracks, which were built on a site known for its megalithic tombs, were completed in 1890. Following the Anglo-Irish Treaty, the barracks were handed over to Irish Free State forces in 1922. In World War II, it was close to the Donegal Corridor. In August 1969 there was false speculation in the media that Taoiseach Jack Lynch would use the barracks to launch an invasion of Northern Ireland in order to protect the Catholic community there. The barracks are now home to the 28th Infantry Battalion, Irish Army.

These barracks have been used to upgrade the heating system of the Donega military barracks which had an LPG boiler installation with copper hot water tanks of about 180 litres in each barracks.



Description of the system

Each barracks is HVAC with an ecoAIR EVI 4-20 kW heat pump as outdoor unit and a CM indoor unit. Each barrack have a 500 litres DHW tank due to the high DHW demands.

The emission system has also been upgraded to underfloor heating to make the most efficient combination and to obtain large savings throughout the year.

Technical scheme of the installation



Single-zone scheme with direct supply to underfloor heating.



Photographs of the installation



Alcorcón, 42 homes linked by HVAC

ALCORCON PROJECT

42 Houses with centralized installation



Alcorcón, 42 homes



The construction sector, as an important consumer of energy, is also rapidly evolving their goals towards greater levels of efficiency.

That is why the housing cooperative Scaya Alcorcón Sociedad Cooperativa Madrileña, who promote of the project developed by NOIR Arquitectura, has established requirements for high energy efficiency and savings for the HVAC system along with the production of hot water for the 42 Single Family Homes in the municipality of Alcorcón in Madrid. The construction has recently started, and incorporates a custom designed air conditioning system along with the production of sanitary hot water, which is also used as a producer of energy for the heat pumps next to radiant-cooling floor as distribution system.

Installation summary

Location:	Alcorcón, Spain
Year:	2018
Installer:	Akiter
Type of installation:	Ground Source
Power:	210 kW
Services:	Heating, Active Cooling and DHW



*Alcorcon, 42 homes linked by
HVAC*



Background

The housing cooperative Scaya Alcorcón Sociedad established requirements for high energy efficiency and savings for the HVAC system and production of hot water from the 42 Single Family Homes in the municipality of Alcorcón in Madrid.

The housing project consists of 42 attached single-family homes, there are five types, differentiated by size and distribution. Each of them has two habitable floors and a garage floor (below ground level). The homes have an area of between 68m² and 150m² with underfloor heating on two floors (ground floor and first floor). The total heated area is 4,566m².

Description of the system

To extract the necessary heat from the ground, 30 vertical boreholes of 135 meters of depth each were dug. The collection system has a total length of 4,050 meters.

The installation comprises of 3 cascading water-water heat pumps. For this reason Ecoforest inverter model ecoGEO HP3 with a power range of 15-70 kW were chosen, because of their excellent modular capabilities.

The peak energy demand will be in heating mode, calculated at 205,000 W. The DHW storage tank is 3,000 l (2 Units) and the inertial tank is only 500 l.

The dispersion of heating and cooling will be through the radiant-cooling floor. Each house has a chronothermostat in the room that will act on a zone valve at the entrance of each dwelling, the rest of the rooms will have an electronic room thermostats installed.

The control of the energy consumption of air conditioning is done by means of energy meters that are installed at the entrance of each dwelling and reports the consumption data to the community administrator.

The control of domestic hot water consumption is through individual volumetric meters located in the same location.



Technical scheme of the installation

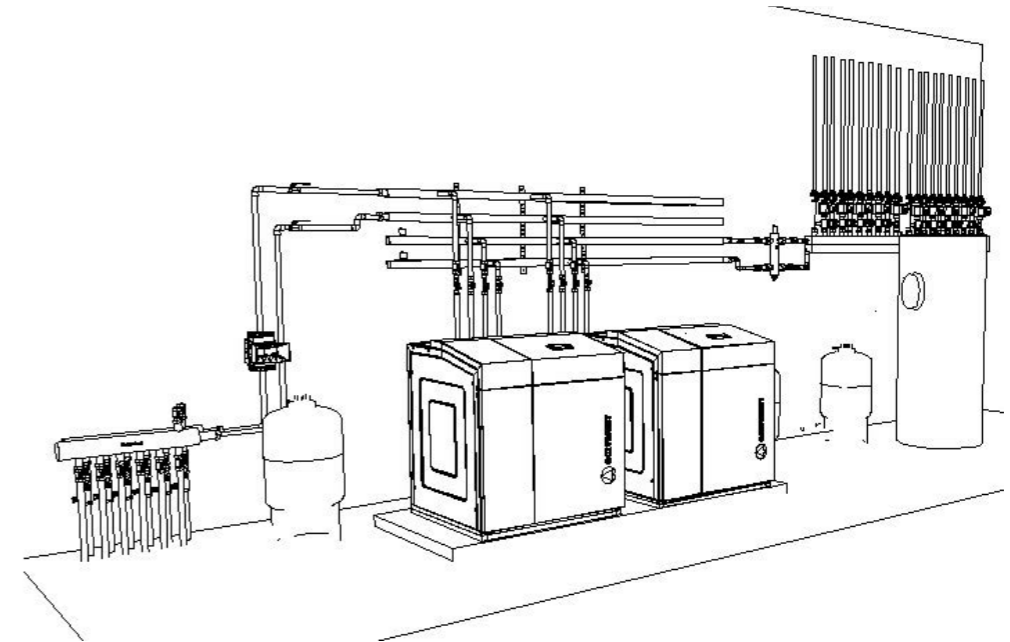



MORE INFORMATION:



www.ecoforest.com
