

Heat pumps

ecoGEO⁺

ecoGEO⁺ & AU

ecoAIR⁺



Ecoforest heat pumps

Technology for a sustainable world

Ecoforest is committed to innovation in order to achieve a sustainable future based on the use of renewable energy. This commitment has led Ecoforest to become a technological leader in the field of Inverter heat pumps, being the only manufacturer whose product range presents such modulating technology in all its models, both geothermal and aérothermal.



Ecoforest heat pumps allow to cover in an integrated way all the thermal needs of current buildings, as well domestic as industrial. Ecoforest offers three types of solutions depending on the energy source used by the equipment: ecoGEO+ water-to-water geothermal heat pumps, ecoGEO+ & AU water-to-water aérothermal heat pumps, and ecoAIR+ aérothermal air-water monobloc heat pumps. All the models in these three ranges make use of Inverter technology to obtain the best performances and thus guarantee comfort and efficiency together with a commitment to make the best use of renewable resources.

INDEX

ecoGEO+	4
ecoGEO+ Basic/Compact PRO	6
ecoGEO+ 1-6 PRO	8
ecoGEO+ 2-10 PRO	10
ecoGEO+ 4-16 PRO	12
ecoGEO+ Basic/Compact	14
ecoGEO+ 1-9	16
ecoGEO+ 3-12	18
ecoGEO+ 5-22	20
ecoGEO+ HP	22
ecoGEO+ 12-40	24
ecoGEO+ 15-70	26
ecoGEO+ 20-85	28
ecoGEO+ 25-100	30
ecoGEO+ & AU	32
ecoGEO+ Basic/Compact & AU	34
Outdoor aérothermal units AU6 / AU12 / AU22	36
ecoGEO+ 1-6 PRO & AU6	38
ecoGEO+ 1-9 & AU12	40
ecoGEO+ 3-12 & AU12	42
ecoGEO+ 5-22 & AU12	44
ecoGEO+ 5-22 & AU22	46
ecoAIR+	48
ecoAIR+ PRO	50
Indoor units CM / HK / HK-Compact	52
ecoAIR+ 1-7 PRO	54
ecoAIR+ 1-9 PRO	56
ecoAIR+ 3-12 PRO	58
ecoAIR+ 3-18 PRO	60
ecoAIR+ EVI	62
Indoor units CM / HK / HK-Compact	64
ecoAIR+ EVI 4-20	66

ecoGEO⁺

Ground source heat pumps



ecoGEO⁺

Inverter ground source, the most efficient technology

The ecoGEO⁺ range is the Ecoforest range of ground source heat pumps. These heat pumps, both domestic and high power, are compatible with any of the type of ground source collection system, even with hybrid air source-ground source collection systems and fully air source collection systems. Likewise, they are also capable of offering all the services required in a HVAC system in an integrated way: DHW, Heating, Pool heating, Passive Cooling (or Free Cooling) and Active Cooling.



All ecoGEO⁺ heat pumps make use of Inverter technology, which allows them to modulate their power in order to adapt to the thermal demands of the installation with the highest efficiency. This translates into a very considerable reduction in electrical consumption and great savings. Thanks to the technology and control strategies developed by Ecoforest, the installation of ecoGEO⁺ heat pumps also becomes much simpler, more compact and cheaper than those of other heat pumps on the market, since it allows to dispense with certain components that would be necessary in traditional heat pump installations.

ecoGEO+ PRO Basic / Compact

Residential range



Power ranges

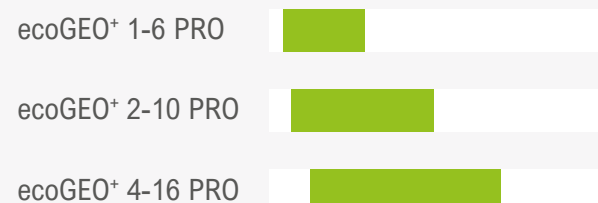

Cascade

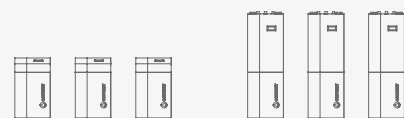

Services



DHW



Heating



Cooling



Pool

Models

ecoGEO+ B1/C1

DHW
Heating
Pool

ecoGEO+ B2/C2

DHW
Heating
Pool
Free Cooling

ecoGEO+ B3/C3

DHW
Heating
Pool
Active Cooling

ecoGEO+ B4/C4

DHW
Heating
Pool
Free Cooling
Active Cooling

Collection system



Ground



Open loop



Air



Hybrid

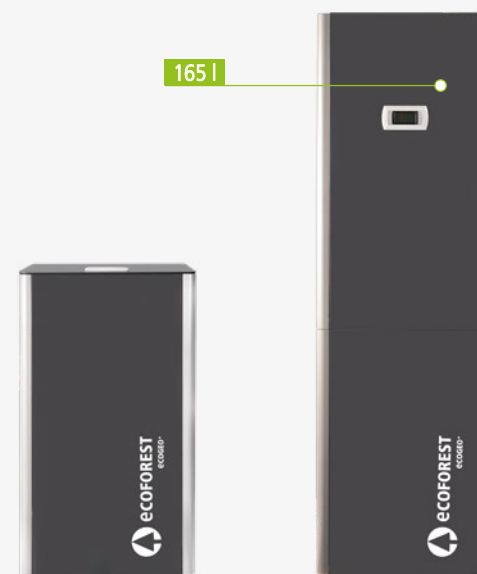

Inverter technology

Power ranges: 1-6 kW / 2-10 kW / 4-16 kW

Domestic hot water production

Heating and pool production

Integrated active cooling production

Integrated passive (free) cooling production

Internet connection through the ecoSMART Easynet

Integrated photovoltaic hybridisation

HTR technology for DHW production up to 75°C and simultaneous production of several services

Natural refrigerant R290

Integrated cascade management up to 3 units

Single-phase (230V) or three-phase (400V) power supply



ecoGEO+ B/C 1-6 PRO



- Modulating thermal power control within a wide range (12,5-100%) and modulating flow rate control of both brine and production circuits (20-100%).
- Natural refrigerant R290 : GWP 3.
- Inverter technology.
- Compact design including brine and production circulation pumps, brine and production expansion vessels (8l and 12l respectively), brine and production safety valves and DHW three-way valve.
- Integrated management of up to 3 different emission temperatures, 2 buffer tanks (heating and cooling), 1 DHW tank, 1 pool and hourly control of DHW recirculation.
- Integrated management of aerothermal collection modulating units, in case of air source or hybrid configurations.
- Integrated management of external On/Off or modulating auxiliary systems, such as electrical heaters, On/Off boilers or modulating boilers.
- Integrated free cooling in models 2 and 4.
- Integrated active cooling in models 3 and 4.
- Single-phase version available.
- Integrated photovoltaic hybridisation.
- Integrated energy meters to measure the electrical consumption, the heating/cooling thermal power, the COP and the monthly and annual SPF.

SPECIFICATIONS ecoGEO+ B/C 1-6 PRO		UNITS	B1/C1	B2/C2	B3/C3	B4/C4
APPLICATION	Place of installation	-	Indoors			
	Type of brine system ¹	-	Ground source / Air source / Hybrid source			
	DHW, Heating and Pool	-	✓	✓	✓	✓
	High Temperature Recovery (HTR) system option	-	-	-	-	-
	Integrated Active cooling	-	-	-	✓	✓
	Integrated Passive cooling	-	-	✓	-	✓
PERFORMANCE	Modulation range of the compressor	%	12,5 to 100			
	Heating power output ² , B0W35	kW	1,0 to 6,0			
	COP ² , B0W35	-	4,3			
	Active cooling power output ² , B35W7	kW	1,0 to 6,0			
	EER ² , B35W7	-	4,4			
	Max. DHW temperature without / with support ⁵	°C	75 / 80			
	Noise power emission level ⁶	db	33 to 44			
OPERATION LIMITS	Energy label / rjs / SCOP W35 average climate control	-	A+++ / 182% / 4,64			
	Energy label / rjs / SCOP W55 average climate control	-	A++ / 140% / 3,60			
	Distribution / Set heating outlet temperature range	°C	10 to 75 / 20 to 75			
	Distribution / Set cooling outlet temperature range	°C	5 to 35 / 7 to 25			
	Brine inlet temperature range in heating applications	°C	-25 to 35			
	Brine inlet temperature range in cooling applications	°C	10 to 75			
	Minimum / Maximum refrigerant circuit pressure	bar	0,5 / 32			
	Production / Pre-load circuit pressure	bar	0,5 to 3,0 / 1,5			
	Brine / Pre-load circuit pressure	bar	0,5 to 3,0 / 0,7			
	Volume / Max. DHW storage tank pressure (ecoGEO+ C)	l / bar	165 / 8			
WORKING FLUIDS	R290 Refrigerant load	kg	0,15			
	Compressor oil type / load	kg	PZ46M / 0,3			
CONTROL ELECTRICAL DATA	1/N/PE 230 V / 50-60 Hz ⁸	-	✓			
	Maximum recommended external protection ⁹	-	-			
	Transformer primary circuit fuse	A	0,5			
	Transformer secondary circuit fuse	A	2,5			
ELECTRICAL DATA: SINGLE-PHASE	1/N/PE 230 V / 50-60 Hz ⁸	-	✓			
	Maximum recommended external protection ⁹	-	C16A			
	Maximum consumption ² , B0W35	kW / A	1,6 / 6,8			
	Maximum consumption ² , B0W55	kW / A	2,0 / 8,6			
	Minimum / Maximum starting current ⁷	A	0,6 / 1,8			
DIMENSIONS/WEIGHT	Correction of cosine Ø	-	0,96 / 1			
	Height x width x depth	mm	ecoGEO+ B: 1058x550x602 · ecoGEO+ C: 1851x600x720			
	Empty weight (without assembly)	kg	B 125 · C 186	B 133 · C 194	B 125 · C 186	B 133 · C 194

1. Air source by replacing the ground source circuit by one or more ecoGEO+ AU air units. Consult the ecoGEO+ AU aerothermal units manual for more detailed information.
 2. In compliance with EN 14511, this includes the consumption of the circulation pumps and the compressor driver.
 3. Considering brine and production flow rates in compliance with EN 14511.
 4. Considering a heat slope from 20°C to 50°C in absence of consumption.
 5. Considering support provided by the emergency electrical heater.
 6. In compliance with EN 12102.
 7. Starting current depends on the working conditions of the hydraulic circuits.
 8. The admissible voltage range for proper operation of the heat pump is ±10%.
 9. Maximum consumption can vary significantly according to working conditions, or if the compressor's operation range is restricted. Consult the technical service manual for more detailed information.
 10. Certification in process.

Dimensions and hydraulic connections

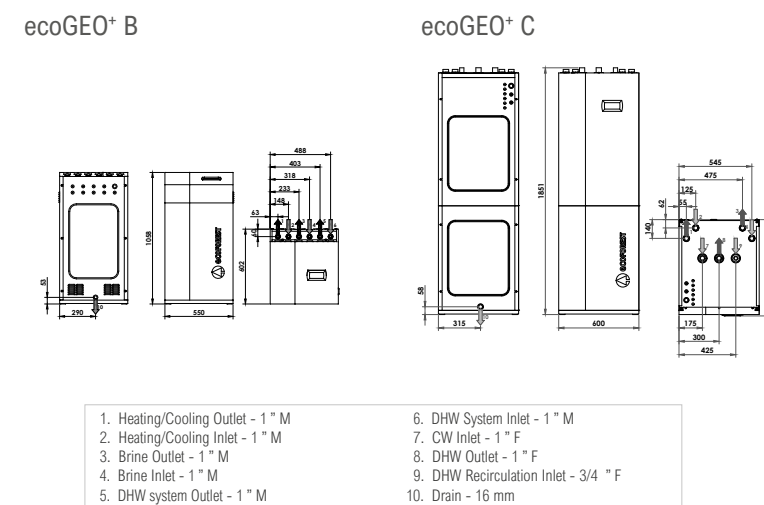

Operational chart

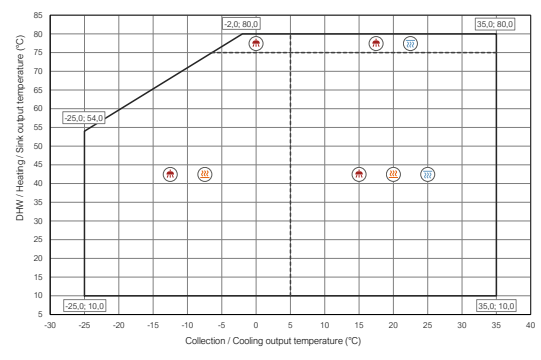

Installation management

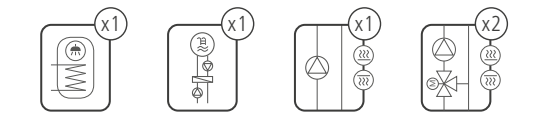

Performance curves

Thermal performance

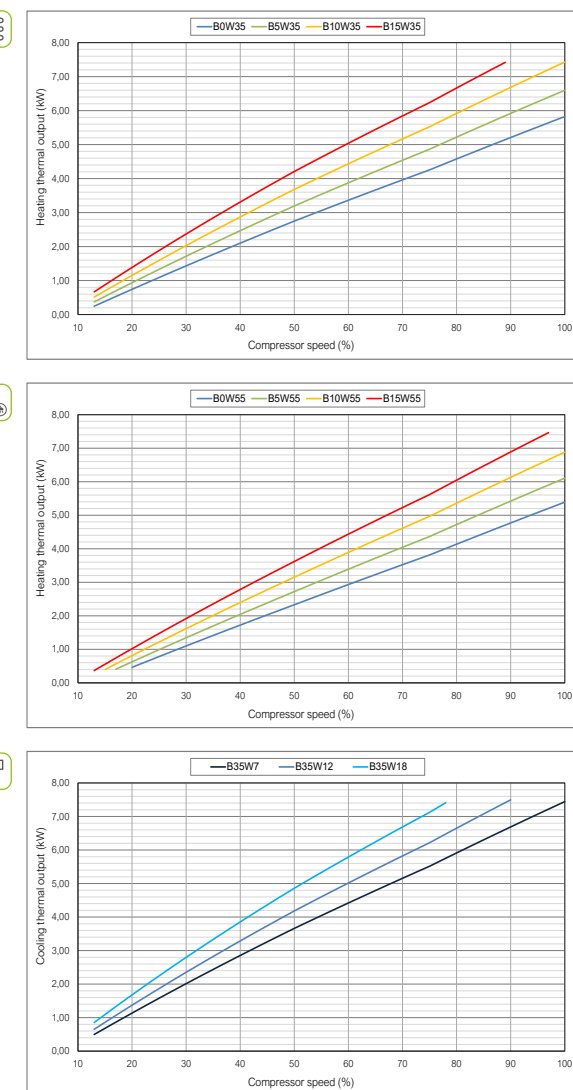

Hydraulic performance

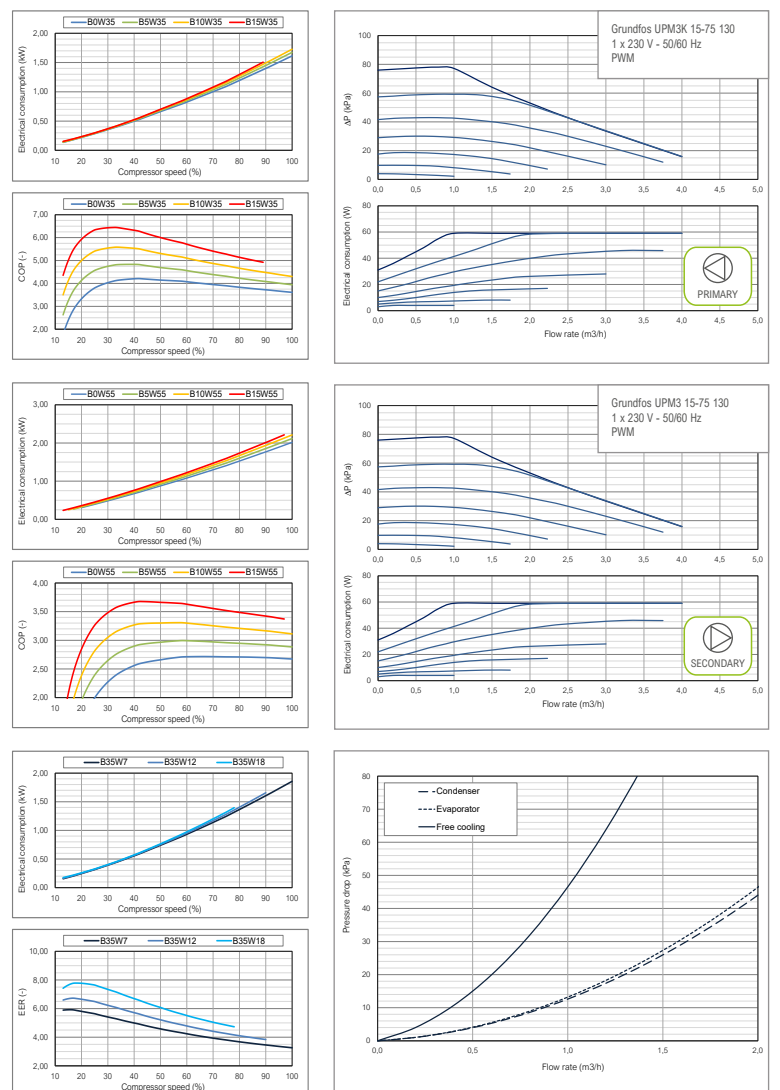

ecoGEO+ B/C 2-10 PRO



- Modulating thermal power control within a wide range (15-100%) and modulating flow rate control of both brine and production circuits (20-100%).
- Natural refrigerant R290 : GWP 3.
- Inverter technology.
- Compact design including brine and production circulation pumps, brine and production expansion vessels (8l and 12l respectively), brine and production safety valves and DHW three-way valve.
- Integrated management of up to 4 different emission temperatures, 2 buffer tanks (heating and cooling), 1 DHW tank, 1 pool and hourly control of DHW recirculation.
- Integrated management of air source collection modulating units, in case of air source or hybrid configurations.
- Integrated management of external On/Off or modulating auxiliary systems, such as electrical heaters, On/Off boilers or modulating boilers.
- Integrated free cooling in models 2 and 4.
- Integrated active cooling in models 3 and 4.
- Single-phase (230V) and three-phase (400V) version available.
- Integrated photovoltaic hybridisation.
- Integrated energy meters to measure the electrical consumption, the heating/cooling thermal power, the COP and the monthly and annual SPF.

SPECIFICATIONS ecoGEO+ B/C 2-10 PRO		UNITS	B1/C1	B2/C2	B3/C3	B4/C4
APPLICATION	Place of installation	-	Indoors			
	Type of brine system ¹	-	Ground source / Air source / Hybrid source			
	DHW, Heating and Pool	-	✓	✓	✓	✓
	High Temperature Recovery (HTR) system option ¹¹	-	✓	✓	✓	✓
	Integrated Active cooling	-	-	-	✓	✓
	Integrated Passive cooling	-	-	✓	-	✓
PERFORMANCE	Modulation range of the compressor	%	15 to 100			
	Heating power output ² , B0W35	kW	1,9 to 10,2			
	COP ² , B0W35	-	4,3			
	Active cooling power output ² , B35W7	kW	1,6 to 8,6			
	EER ² , B35W7	-	4,1			
	Max. DHW temperature without / with support ⁵	°C	75 / 80			
	Noise power emission level ⁶	db	35 to 46			
	Energy label / rjs / SCOP W35 average climate control	-	A+++ / 180% / 4,78			
OPERATION LIMITS	Energy label / rjs / SCOP W55 average climate control	-	A++ / 140% / 3,75			
	Distribution / Set heating outlet temperature range	°C	10 to 70 / 70			
	Distribution / Set cooling outlet temperature range	°C	-20 to 35 / -15			
	Brine inlet temperature range in heating applications	°C	-25 to 35			
	Brine inlet temperature range in cooling applications	°C	10 to 70			
	Minimum / Maximum refrigerant circuit pressure	bar	1 / 32			
	Production / Pre-load circuit pressure	bar	0,5 to 3,0 / 1,5			
	Brine / Pre-load circuit pressure	bar	0,5 to 3,0 / 0,7			
	Volume / Max. DHW storage tank pressure (ecoGEO+ C)	l / bar	165 / 8			
	WORKING FLUIDS	R290 Refrigerant load	kg	0,6		
Compressor oil type / load		kg	HXL4467 / 0,74			
CONTROL ELECTRICAL DATA	1/N/PE 230 V / 50-60 Hz ⁸	-	✓			
	Maximum recommended external protection ⁹	-	C16A			
	Transformer primary circuit fuse	A	0,5			
	Transformer secondary circuit fuse	A	2,5			
ELECTRICAL DATA: SINGLE-PHASE	1/N/PE 230 V / 50-60 Hz ⁸	-	✓			
	Maximum recommended external protection ⁹	-	C25A			
	Maximum consumption ² , B0W35	kW / A	2,9 / 12,4			
	Maximum consumption ² , B0W35	kW / A	3,7 / 15,9			
	Minimum / Maximum starting current ⁷	A	2,8 / 5,8			
ELECTRICAL DATA: THREE-PHASE	Correction of cosine Ø	-	0,96 / 1			
	3/N/PE 400 V / 50-60 Hz ⁸	-	✓			
	Maximum recommended external protection ⁹	-	C13A			
	Maximum consumption ² , B0W35	kW / A	2,9 / 4,1			
	Maximum consumption ² , B0W35	kW / A	3,7 / 5,3			
DIMENSIONS/WEIGHT	Minimum / Maximum starting current ⁷	A	0,9 / 4,2			
	Correction of cosine Ø	-	0,96 / 1			
DIMENSIONS/WEIGHT	Height x width x depth	mm	ecoGEO+ B: 1051x609x716 · ecoGEO+ C: 1943x609x724			
	Empty weight (without assembly)	kg	B 195 · C 260	B 205 · C 270	B 195 · C 260	B 205 · C 270

1. Air source by replacing the ground source circuit by one or more ecoGEO+ AU air units. Consult the ecoGEO+ AU athermal units manual for more detailed information.
 2. In compliance with EN 14511, this includes the consumption of the circulation pumps and the compressor driver.
 3. Considering brine and production flow rates in compliance with EN 14511.
 4. Considering a heat slope from 20°C to 50°C in absence of consumption.
 5. Considering support provided by the emergency electrical heater.
 6. In compliance with EN 12102.
 7. Starting current depends on the working conditions of the hydraulic circuits.
 8. The admissible voltage range for proper operation of the heat pump is ±10%.
 9. Maximum consumption can vary significantly according to working conditions, or if the compressor's operation range is restricted. Consult the technical service manual for more detailed information.
 10. Certification in process.
 11. Integrated by default in modules B3/C3 and B4/C4.

Dimensions and hydraulic connections

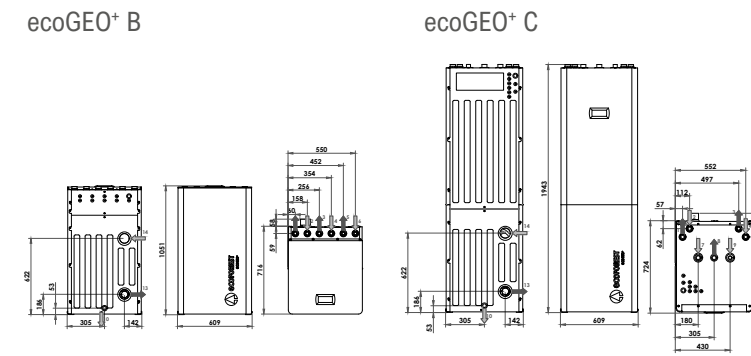

1. Heating/Cooling Outlet - 1 1/4" M
2. Heating/Cooling Inlet - 1 1/4" M
3. Brine Outlet - 1 1/4" M
4. Brine Inlet - 1 1/4" M
5. DHW system Outlet - 1 1/4" M
6. DHW System Inlet - 1 1/4" M
7. CW Inlet - 1" F
8. DHW Outlet - 1" F
9. DHW Recirculation Inlet - 3/4" F
10. Drain - 16 mm
11. Safety duct outlet - Ø80
12. Safety duct inlet - Ø80

Operational chart

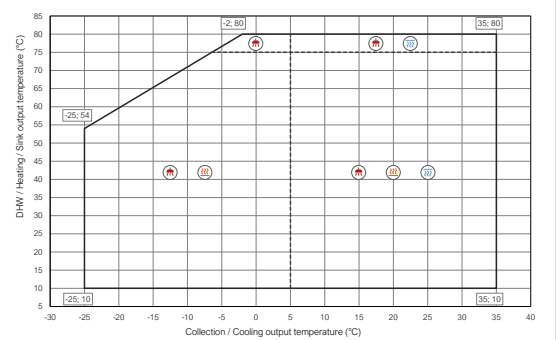

Installation management

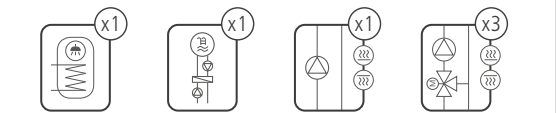

Performance curves

Thermal performance

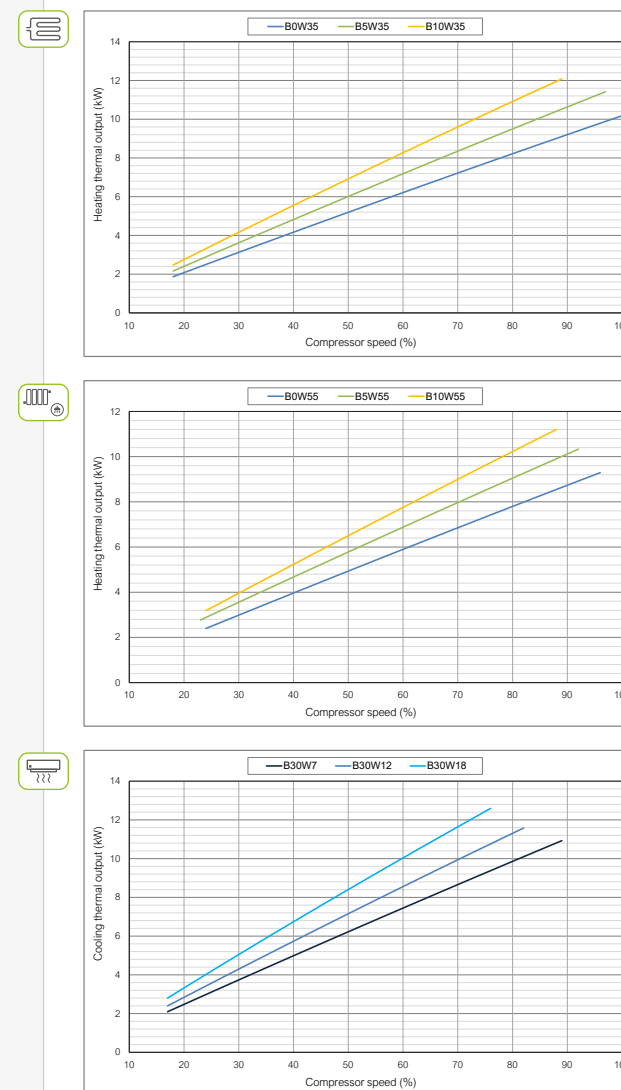

Hydraulic performance

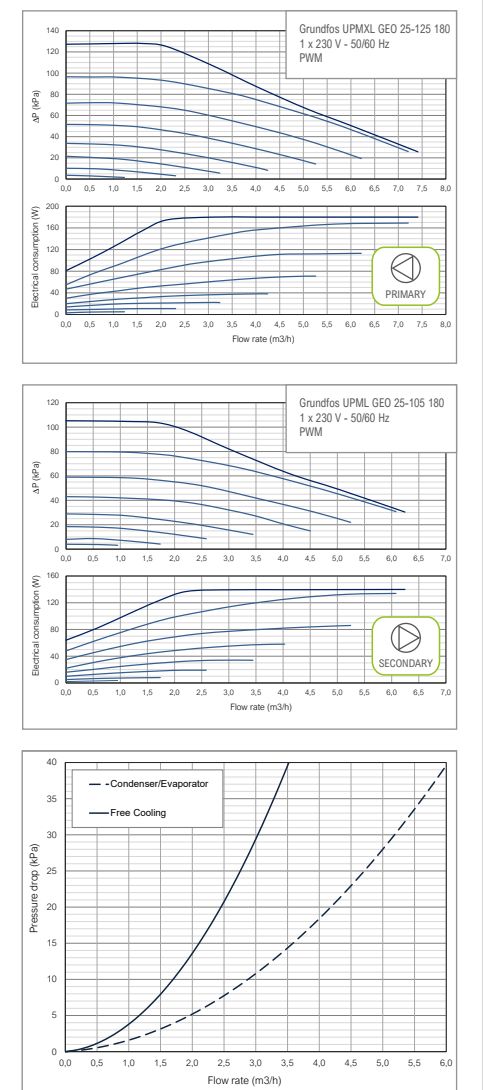

ecoGEO+ B/C 4-16 PRO



- Modulating thermal power control within a wide range (15-100%) and modulating flow rate control of both brine and production circuits (20-100%).
- Natural refrigerant R290 : GWP 3.
- Inverter technology.
- Compact design including brine and production circulation pumps, brine and production expansion vessels (8l and 12l respectively), brine and production safety valves and DHW three-way valve.
- Integrated management of up to 4 different emission temperatures, 2 buffer tanks (heating and cooling), 1 DHW tank, 1 pool and hourly control of DHW recirculation.
- Integrated management of air source collection modulating units, in case of air source or hybrid configurations.
- Integrated management of external On/Off or modulating auxiliary systems, such as electrical heaters, On/Off boilers or modulating boilers.
- Integrated free cooling in models 2 and 4.
- Integrated active cooling in models 3 and 4.
- Single-phase (230V) and three-phase (400V) version available.
- Integrated photovoltaic hybridisation.
- Integrated energy meters to measure the electrical consumption, the heating/cooling thermal power, the COP and the monthly and annual SPF.

SPECIFICATIONS ecoGEO+ B/C 4-16 PRO		UNITS	B1/C1	B2/C2	B3/C3	B4/C4
APPLICATION	Place of installation	-	Indoors			
	Type of brine system ¹	-	Ground source / Air source / Hybrid source			
	DHW, Heating and Pool	-	✓	✓	✓	✓
	High Temperature Recovery (HTR) system option ¹¹	-	✓	✓	✓	✓
	Integrated Active cooling	-	-	-	✓	✓
	Integrated Passive cooling	-	-	✓	-	✓
PERFORMANCE	Modulation range of the compressor	%	15 to 100			
	Heating power output ² , B0W35	kW	3,1 to 16,1			
	COP ² , B0W35	-	4,6			
	Active cooling power output ² , B35W7	kW	2,2 to 13,8			
	EER ² , B35W7	-	3,7			
	Max. DHW temperature without / with support ⁵	°C	75 / 80			
	Noise power emission level ⁶	db	35 to 46			
	Energy label / rjs / SCOP W35 average climate control	-	A+++ / 188% / 4,85			
OPERATION LIMITS	Energy label / rjs / SCOP W55 average climate control	-	A++ / 146% / 3,84			
	Distribution / Set heating outlet temperature range	°C	10 to 70 / 70			
	Distribution / Set cooling outlet temperature range	°C	-20 to 35 / -15			
	Brine inlet temperature range in heating applications	°C	-25 to 35			
	Brine inlet temperature range in cooling applications	°C	10 to 70			
	Minimum / Maximum refrigerant circuit pressure	bar	1 / 32			
	Production / Pre-load circuit pressure	bar	0,5 to 3,0 / 1,5			
	Brine / Pre-load circuit pressure	bar	0,5 to 3,0 / 0,7			
	Volume / Max. DHW storage tank pressure (ecoGEO+ C)	l / bar	165 / 8			
	WORKING FLUIDS	R290 Refrigerant load	kg	0,86		
Compressor oil type / load		kg	HXL4467 / 1,18			
CONTROL ELECTRICAL DATA	1/N/PE 230 V / 50-60 Hz ⁸	-	✓			
	Maximum recommended external protection ⁹	-	C16A			
	Transformer primary circuit fuse	A	0,5			
	Transformer secondary circuit fuse	A	2,5			
ELECTRICAL DATA: SINGLE-PHASE	1/N/PE 230 V / 50-60 Hz ⁸	-	✓			
	Maximum recommended external protection ⁹	-	C32A			
	Maximum consumption ² , B0W35	kW / A	4,4 / 19,2			
	Maximum consumption ² , B0W35	kW / A	5,5 / 23,9			
	Minimum / Maximum starting current ⁷	A	2,6 / 12,5			
ELECTRICAL DATA: THREE-PHASE	Correction of cosine Ø	-	0,96 / 1			
	3/N/PE 400 V / 50-60 Hz ⁸	-	✓			
	Maximum recommended external protection ⁹	-	C13A			
	Maximum consumption ² , B0W35	kW / A	4,4 / 6,4			
	Maximum consumption ² , B0W35	kW / A	5,5 / 7,9			
DIMENSIONS/WEIGHT	Height x width x depth	mm	ecoGEO+ B: 1051x609x716 · ecoGEO+ C: 1943x609x724			
	Empty weight (without assembly)	kg	B 195 · C 260	B 205 · C 270	B 195 · C 260	B 205 · C 270

1. Air source by replacing the ground source circuit by one or more ecoGEO+ AU air units. Consult the ecoGEO+ AU athermal units manual for more detailed information.
 2. In compliance with EN 14511, this includes the consumption of the circulation pumps and the compressor driver.
 3. Considering brine and production flow rates in compliance with EN 14511.
 4. Considering a heat slope from 20°C to 50°C in absence of consumption.
 5. Considering support provided by the emergency electrical heater.
 6. In compliance with EN 12102.
 7. Starting current depends on the working conditions of the hydraulic circuits.
 8. The admissible voltage range for proper operation of the heat pump is ±10%.
 9. Maximum consumption can vary significantly according to working conditions, or if the compressor's operation range is restricted. Consult the technical service manual for more detailed information.
 10. Certification in process.
 11. Integrated by default in modules B3/C3 and B4/C4.

Dimensions and hydraulic connections

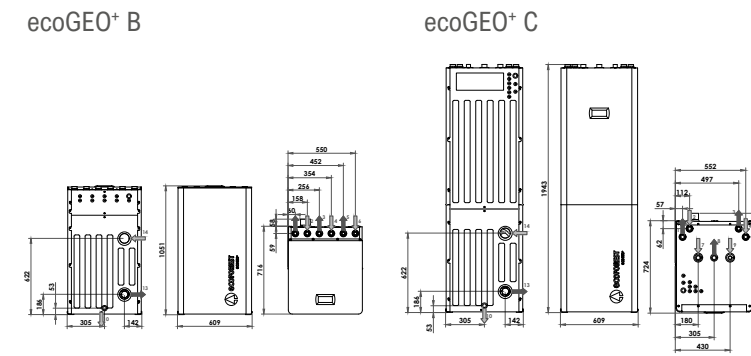

1. Heating/Cooling Outlet - 1 1/4" M
2. Heating/Cooling Inlet - 1 1/4" M
3. Brine Outlet - 1 1/4" M
4. Brine Inlet - 1 1/4" M
5. DHW system Outlet - 1 1/4" M
6. DHW System Inlet - 1 1/4" M
7. CW Inlet - 1" F
8. DHW Outlet - 1" F
9. DHW Recirculation Inlet - 3/4" F
10. Drain - 16 mm
11. Safety duct outlet - Ø80
12. Safety duct inlet - Ø80

Operational chart

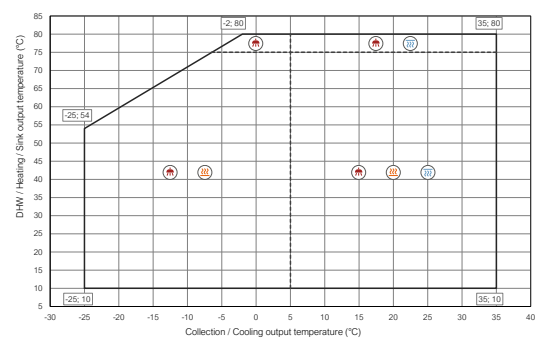

Installation management

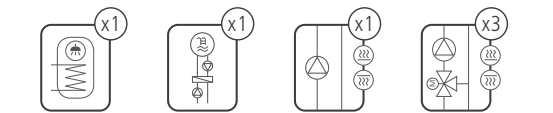

Performance curves

Thermal performance

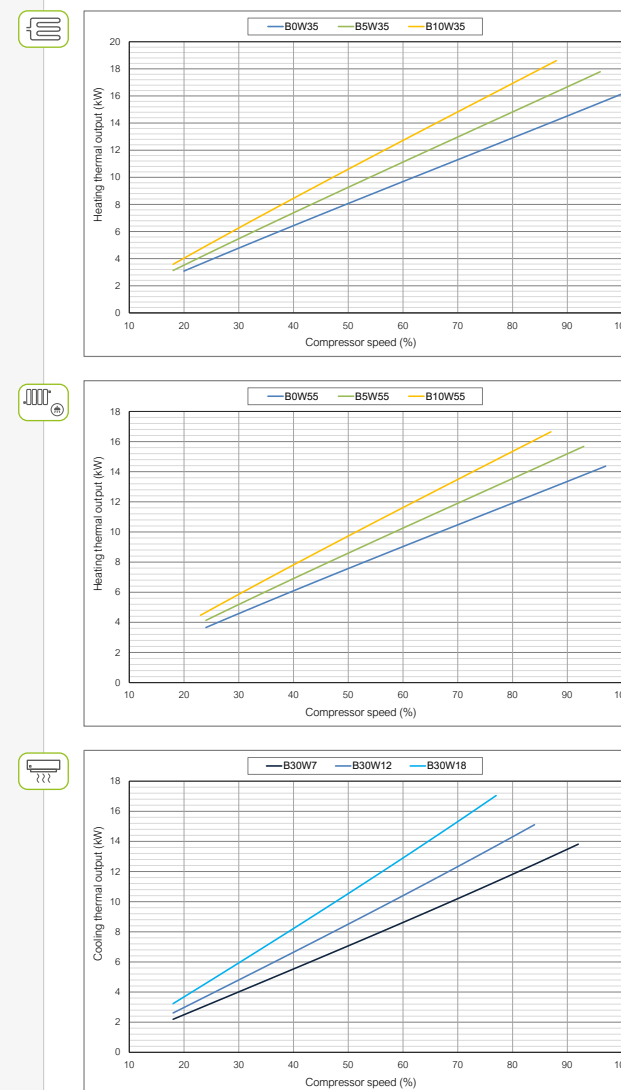

Hydraulic performance

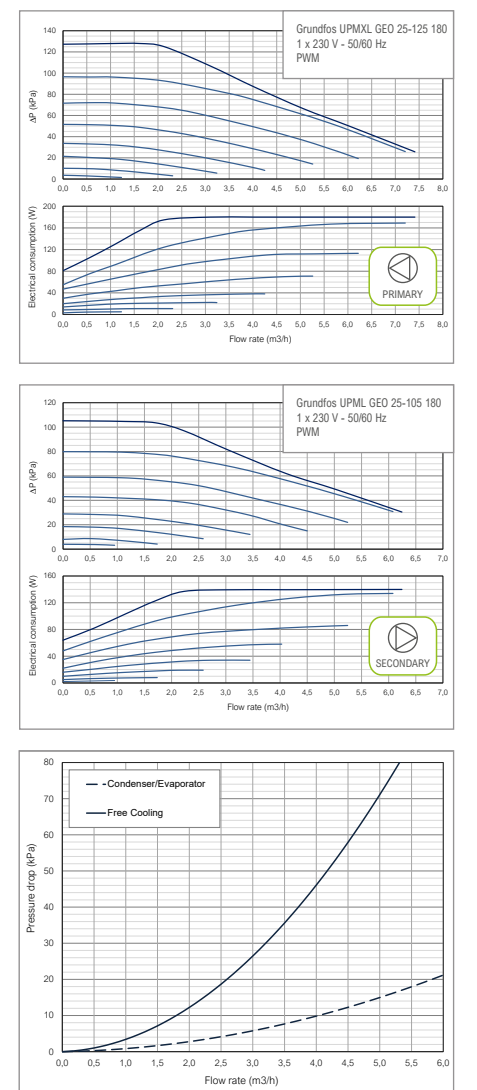

ecoGEO+ Basic / Compact

Residential range



Power ranges



Cascade

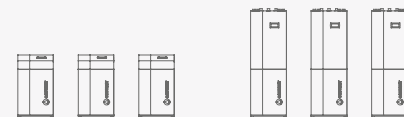

Services



DHW



Heating



Cooling



Pool

Models

ecoGEO+ B1/C1

DHW
Heating
Pool

ecoGEO+ B2/C2

DHW
Heating
Pool
Free Cooling

ecoGEO+ B3/C3

DHW
Heating
Pool
Active Cooling

ecoGEO+ B4/C4

DHW
Heating
Pool
Free Cooling
Active Cooling

Collection system



Ground



Open loop



Air



Hybrid

Inverter technology

Power ranges: 1-9 kW / 3-12 kW / 5-22 kW

Domestic hot water production

Heating and pool production

Integrated active cooling production

Integrated passive (free) cooling production

Internet connection through the ecoSMART Easynet

Integrated photovoltaic hybridisation

HTR technology for DHW production up to 70°C and simultaneous production of several services

Integrated cascade management up to 3 units

Single-phase (230V) or three-phase (400V) power supply



ecoGEO+ B/C 1-9

- Modulating thermal power control within a wide range (12,5-100%) and modulating flow rate control of both brine and production circuits (20-100%).
- Inverter technology and scroll compressor.
- Compact design including brine and production circulation pumps, brine and production expansion vessels (8l and 12l respectively), brine and production safety valves and DHW three-way valve.
- High Temperature Recovery system (HTR) for DHW production up to 70 °C without electrical support and simultaneous production of DHW and heating/cooling.
- Integrated management of up to 4 different emission temperatures, 2 buffer tanks (heating and cooling), 1 DHW tank, 1 pool and hourly control of DHW recirculation.
- Integrated management of aerothermal collection modulating units, in case of air source or hybrid configurations.
- Integrated management of external On/Off or modulating auxiliary systems, such as electrical heaters, On/Off boilers or modulating boilers.
- Integrated management of cascade systems up to 3 units.
- Integrated management of simultaneous cooling/heating systems according to scheme.
- Integrated free cooling in models 2 and 4.
- Integrated active cooling in models 3 and 4.
- Single-phase and Three-phase versions available.
- Integrated photovoltaic hybridisation.
- Integrated energy meters to measure the electrical consumption, the heating/cooling thermal power, the COP and the monthly and annual SPF.

SPECIFICATIONS ecoGEO+ B/C 1-9		UNITS	B1/C1	B2/C2	B3/C3	B4/C4	
APPLICATION	Place of installation	-	Indoors				
	Type of brine system ¹	-	Ground source / Air source / Hybrid source				
	DHW, Heating and Pool	-	✓	✓	✓	✓	
	High Temperature Recovery (HTR) system option	-	✓	✓	✓ by default	✓ by default	
	Integrated Active cooling	-	-	-	✓	✓	
	Integrated Passive cooling	-	-	✓	-	✓	
PERFORMANCE	Modulation range of the compressor	%	12,5 to 100				
	Heating power output ² , B0W35	kW	1,3 to 11,0				
	COP ² , B0W35	-	4,5				
	Active cooling power output ² , B35W7	kW	-	1,4 to 11,0			
	EER ² , B35W7	-	-	5,2			
	Max. DHW temperature without / with support ⁵	°C	63 / 70				
	Noise power emission level ⁶	db	33 to 44				
	Energy label / rjs / SCOP W35 average climate control	-	A+++ / 190% / 4,84				
	Energy label / rjs / SCOP W55 average climate control	-	A++ / 138% / 3,54				
	OPERATION LIMITS	Distribution / Set heating outlet temperature range	°C	10 to 60 / 20 to 60			
Distribution / Set cooling outlet temperature range		°C	5 to 35 / 7 to 25				
Brine inlet temperature range in heating applications		°C	-25 to 35				
Brine inlet temperature range in cooling applications		°C	10 to 60				
Minimum / Maximum refrigerant circuit pressure		bar	2 / 45				
Production / Pre-load circuit pressure		bar	0,5 to 3,0 / 1,5				
Brine / Pre-load circuit pressure		bar	0,5 to 3,0 / 0,7				
Volume / Max. DHW storage tank pressure (ecoGEO+ C)		l / bar	165 / 8				
WORKING FLUIDS	R410A Refrigerant load without HTR / with HTR	kg	0,8 / 0,85 1,0				
	Compressor oil type / load	kg	POE / 0,74				
CONTROL ELECTRICAL DATA	1/N/PE 230 V / 50-60 Hz ⁸	-	✓				
	Maximum recommended external protection ⁹	-	C16				
	Transformer primary circuit fuse	A	0,5				
ELECTRICAL DATA: SINGLE-PHASE	Transformer secondary circuit fuse	A	2,5				
	1/N/PE 230 V / 50-60 Hz ⁸	-	✓				
	Maximum recommended external protection ⁹	-	C25A				
	Maximum consumption ² , B0W35	kW / A	2,7 / 11,8				
	Maximum consumption ² , B0W55	kW / A	3,8 / 16,5				
ELECTRICAL DATA: THREE-PHASE	Minimum / Maximum starting current ⁷	A	2,8 / 5,8				
	Correction of cosine Ø	-	0,96 / 1				
	3/N/PE 400 V / 50-60Hz ⁸	-	✓				
	Maximum recommended external protection ⁹	-	C10A				
	Maximum consumption ² , B0W35	kW / A	2,7 / 4,0				
DIMENSIONS/WEIGHT	Maximum consumption ² , B0W55	kW / A	3,8 / 5,5				
	Minimum / Maximum starting current ⁷	A	0,9 / 1,9				
DIMENSIONS/WEIGHT	Correction of cosine Ø	-	0,96 / 1				
	Height x width x depth	mm	ecoGEO+ B: 1058x600x710 · ecoGEO+ C: 1851x600x720				
DIMENSIONS/WEIGHT	Empty weight (without assembly)	kg	B 184 · C 245 B 192 · C 253 B 184 · C 245 B 192 · C 253				

1. Air source/Hybrid source by replacing/combining the ground source circuit by/with one or more ecoGEO+ AU. Consult the ecoGEO+ AU manual for more detailed information.
 2. In compliance with EN 14511, this includes the consumption of the circulation pumps and the compressor driver.
 3. Considering brine and production flow rates in compliance with EN 14511.
 4. Considering a heat slope from 20°C to 50°C in absence of consumption.
 5. Considering support provided by the emergency electrical heater or the HTR system. Maximum DHW temperature with the HTR system can be limited by
 6. the compressor discharge temperature.
 7. In compliance with EN 12102.
 8. Starting current depends on the working conditions of the hydraulic circuits.
 9. The admissible voltage range for proper operation of the heat pump is ±10%.
 10. Maximum consumption can vary significantly according to working conditions, or if the compressor's operation range is restricted. Consult the technical service manual for more detailed information.
 Certification in process.

Dimensions and hydraulic connections

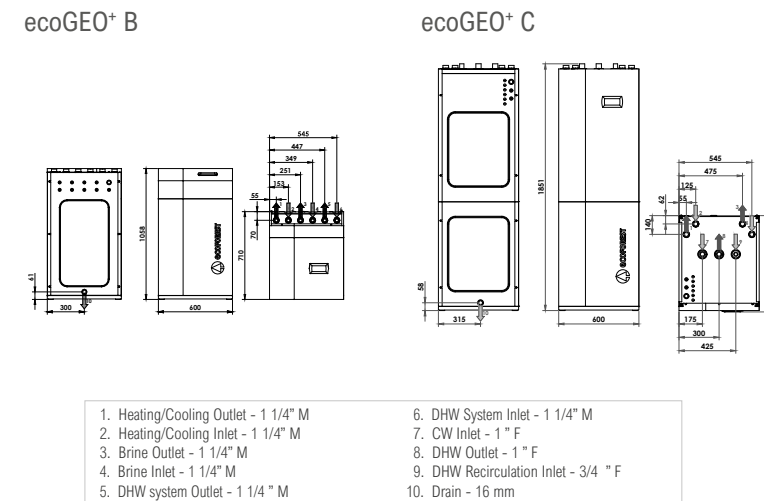

Operational chart

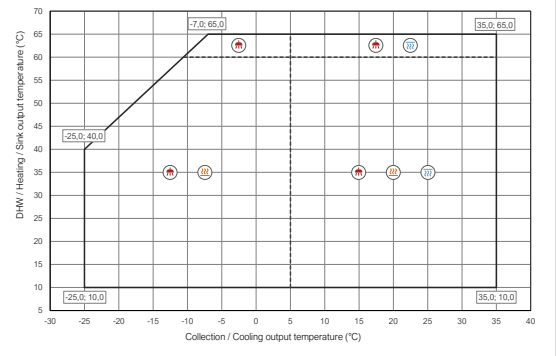

Installation management

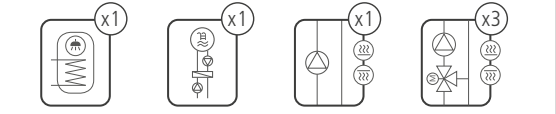

Performance curves

Thermal performance

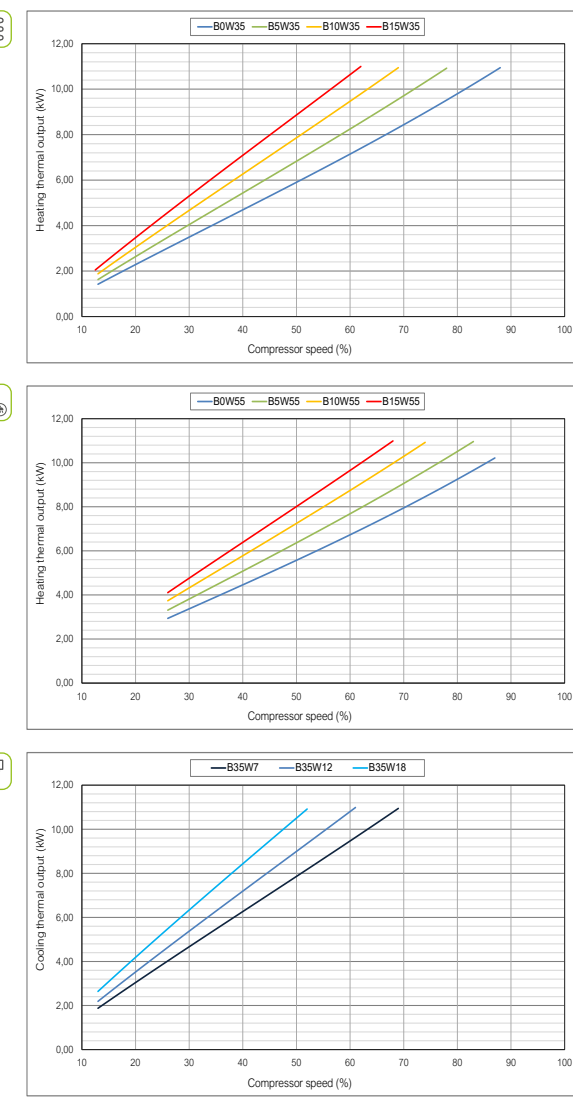

Hydraulic performance

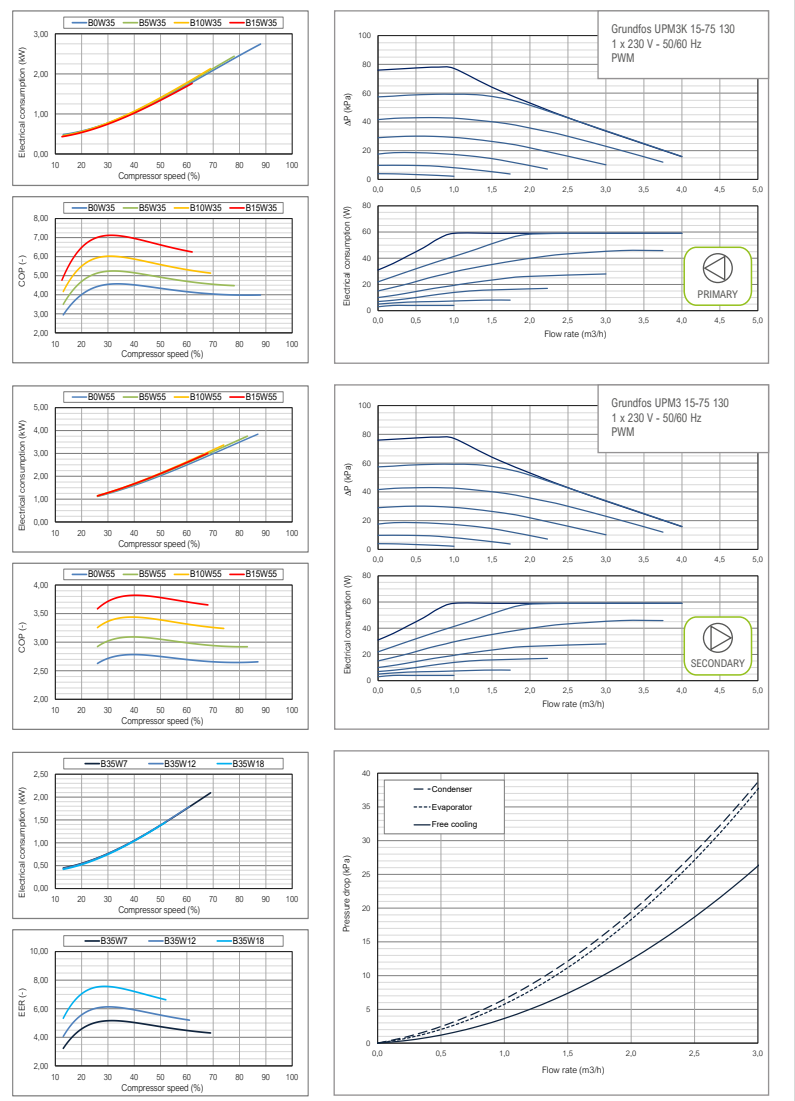

ecoGEO+ B/C 3-12

- Modulating thermal power control within a wide range (12,5-100%) and modulating flow rate control of both brine and production circuits (20-100%).
- Inverter technology and scroll compressor.
- Compact design including brine and production circulation pumps, brine and production expansion vessels (8l and 12l respectively), brine and production safety valves and DHW three-way valve.
- High Temperature Recovery system (HTR) for DHW production up to 70 °C without electrical support and simultaneous production of DHW and heating/cooling.
- Integrated management of up to 4 different emission temperatures, 2 buffer tanks (heating and cooling), 1 DHW tank, 1 pool and hourly control of DHW recirculation.
- Integrated management of aérothermal collection modulating units, in case of air source or hybrid configurations.
- Integrated management of external On/Off or modulating auxiliary systems, such as electrical heaters, On/Off boilers or modulating boilers.
- Integrated management of cascade systems up to 3 units.
- Integrated management of simultaneous cooling/heating systems according to scheme.
- Integrated free cooling in models 2 and 4.
- Integrated active cooling in models 3 and 4.
- Single-phase and Three-phase versions available.
- Integrated photovoltaic hybridisation.
- Integrated energy meters to measure the electrical consumption, the heating/cooling thermal power, the COP and the monthly and annual SPF.

SPECIFICATIONS ecoGEO+ B/C 3-12		UNITS	B1/C1	B2/C2	B3/C3	B4/C4
APPLICATION	Place of installation	-	Indoors			
	Type of brine system ¹	-	Ground source / Air source / Hybrid source			
	DHW, Heating and Pool	-	✓	✓	✓	✓
	High Temperature Recovery (HTR) system option	-	✓	✓	✓ by default	✓ by default
	Integrated Active cooling	-	-	-	✓	✓
	Integrated Passive cooling	-	-	✓	-	✓
PERFORMANCE	Modulation range of the compressor	%	12,5 to 100			
	Heating power output ² , B0W35	kW	2,1 to 16,0			
	COP ² , B0W35	-	4,6			
	Active cooling power output ² , B35W7	kW	2,1 to 15,0			
	EER ² , B35W7	-	5,2			
	Max. DHW temperature without / with support ⁵	°C	63 / 70			
	Noise power emission level ⁶	db	34 to 45			
	Energy label / rjs / SCOP W35 average climate control	-	A+++ / 194% / 4,95			
	Energy label / rjs / SCOP W55 average climate control	-	A++ / 142% / 3,65			
	Distribution / Set heating outlet temperature range	°C	10 to 60 / 20 to 60			
Distribution / Set cooling outlet temperature range	°C	5 to 35 / 7 to 25				
Brine inlet temperature range in heating applications	°C	-25 to 35				
Brine inlet temperature range in cooling applications	°C	10 to 60				
Minimum / Maximum refrigerant circuit pressure	bar	2 / 45				
Production / Pre-load circuit pressure	bar	0,5 to 3,0 / 1,5				
Brine / Pre-load circuit pressure	bar	0,5 to 3,0 / 0,7				
Volume / Max. DHW storage tank pressure (ecoGEO+ C)	l / bar	165 / 8				
WORKING FLUIDS	R410A Refrigerant load without HTR / with HTR	kg	0,9 / 1,0		1,0	
	Compressor oil type / load	kg	POE / 0,74			
CONTROL ELECTRICAL DATA	1/N/PE 230 V / 50-60 Hz ⁸	-	✓			
	Maximum recommended external protection ⁹	-	C16A			
	Transformer primary circuit fuse	A	0,5			
	Transformer secondary circuit fuse	A	2,5			
ELECTRICAL DATA: SINGLE-PHASE	1/N/PE 230 V / 50-60 Hz ⁸	-	✓			
	Maximum recommended external protection ⁹	-	C32A			
	Maximum consumption ² , B0W35	kW / A	4,2 / 18,6			
	Maximum consumption ² , B0W55	kW / A	5,0 / 21,7			
	Minimum / Maximum starting current ⁷	A	2,0 / 8,0			
ELECTRICAL DATA: THREE-PHASE	3/N/PE 400 V / 50-60Hz ⁸	-	✓			
	Maximum recommended external protection ⁹	-	C16A			
	Maximum consumption ² , B0W35	kW / A	4,2 / 6,2			
	Maximum consumption ² , B0W55	kW / A	5,0 / 7,2			
	Minimum / Maximum starting current ⁷	A	0,7 / 2,6			
DIMENSIONS/WEIGHT	Height x width x depth	mm	ecoGEO+ B: 1058x600x710 · ecoGEO+ C: 1851x600x720			
	Empty weight (without assembly)	kg	B 185 · C 246	B 193 · C 254	B 185 · C 246	B 193 · C 254

1. Air source/Hybrid source by replacing/combining the ground source circuit by/with one or more ecoGEO+ AU. Consult the ecoGEO+ AU manual for more detailed information.
 2. In compliance with EN 14511, this includes the consumption of the circulation pumps and the compressor driver.
 3. Considering brine and production flow rates in compliance with EN 14511.
 4. Considering a heat slope from 20°C to 50°C in absence of consumption.
 5. Considering support provided by the emergency electrical heater or the HTR system. Maximum DHW temperature with the HTR system can be limited by
 6. In compliance with EN 12102.
 7. Starting current depends on the working conditions of the hydraulic circuits.
 8. The admissible voltage range for proper operation of the heat pump is ±10%.
 9. Maximum consumption can vary significantly according to working conditions, or if the compressor's operation range is restricted. Consult the technical service manual for more detailed information.
 10. Certification in process.

Dimensions and hydraulic connections

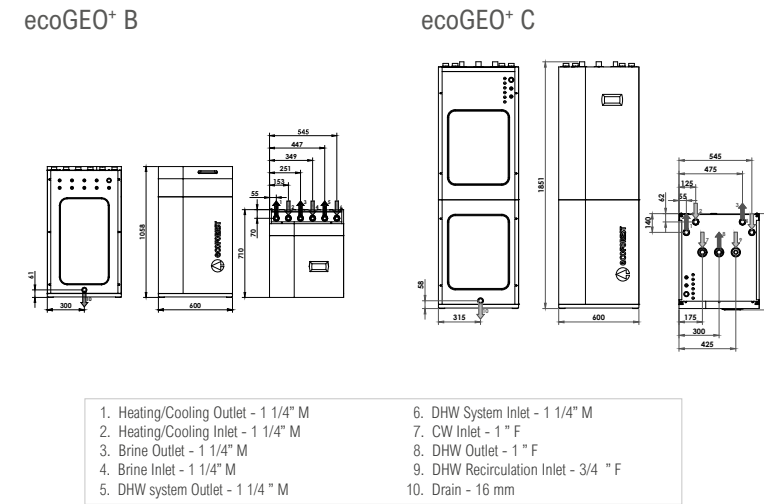

Operational chart

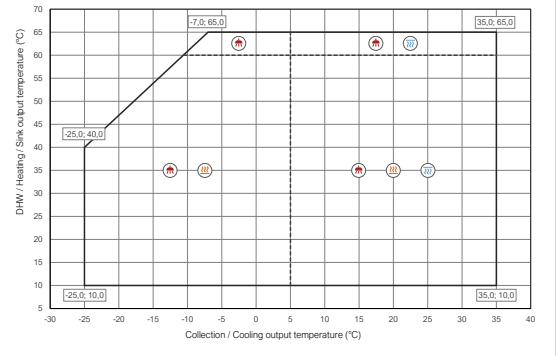

Installation management

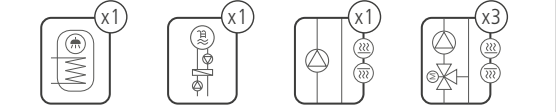

Performance curves

Thermal performance

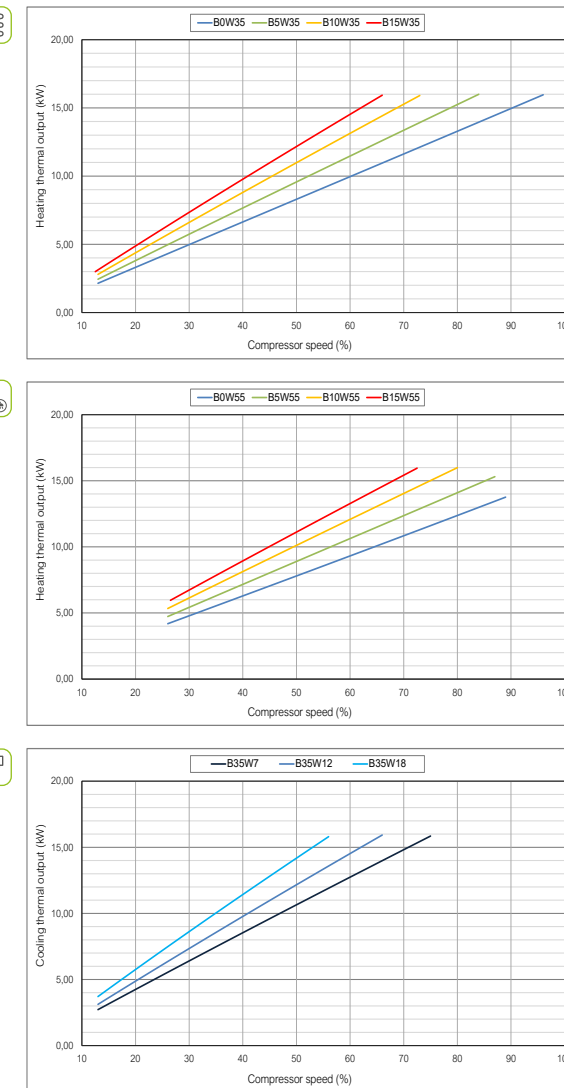

Hydraulic performance

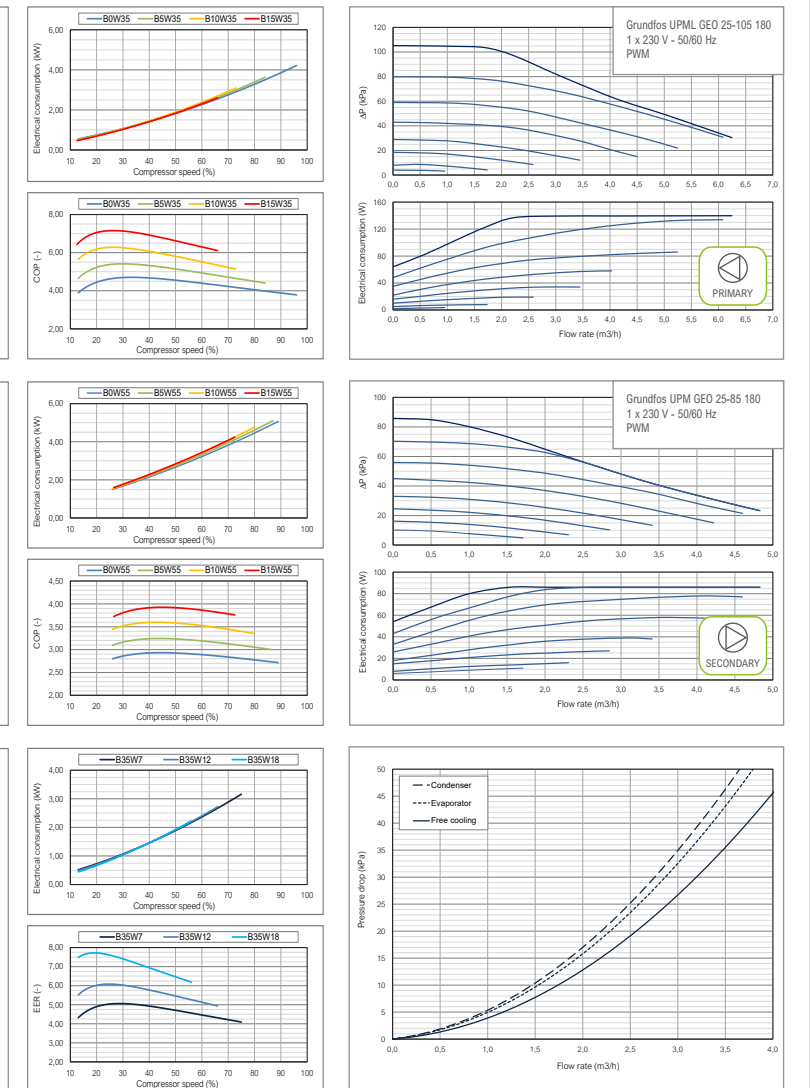

ecoGEO+ B/C 5-22

- Modulating thermal power control within a wide range (15-100%) and modulating flow rate control of both brine and production circuits (20-100%).
- Inverter technology and scroll compressor.
- Compact design including brine and production circulation pumps, brine and production expansion vessels (8l and 12l respectively), brine and production safety valves and DHW three-way valve.
- High Temperature Recovery system (HTR) for DHW production up to 70 °C without electrical support and simultaneous production of DHW and heating/cooling.
- Integrated management of up to 4 different emission temperatures, 2 buffer tanks (heating and cooling), 1 DHW tank, 1 pool and hourly control of DHW recirculation.
- Integrated management of aerothermal collection modulating units, in case of air source or hybrid configurations.
- Integrated management of external On/Off or modulating auxiliary systems, such as electrical heaters, On/Off boilers or modulating boilers.
- Integrated management of cascade systems up to 3 units.
- Integrated management of simultaneous cooling/heating systems according to scheme.
- Integrated free cooling in models 2 and 4.
- Integrated active cooling in models 3 and 4.
- Single-phase and Three-phase versions available.
- Integrated photovoltaic hybridisation.
- Integrated energy meters to measure the electrical consumption, the heating/cooling thermal power, the COP and the monthly and annual SPF.

SPECIFICATIONS ecoGEO+ B/C 5-22		UNITS	B1/C1	B2/C2	B3/C3	B4/C4	
APPLICATION	Place of installation	-	Indoors				
	Type of brine system ¹	-	Ground source / Air source / Hybrid source				
	DHW, Heating and Pool	-	✓	✓	✓	✓	
	High Temperature Recovery (HTR) system option	-	✓	✓	✓ by default	✓ by default	
	Integrated Active cooling	-	-	-	✓	✓	
	Integrated Passive cooling	-	-	✓	-	✓	
PERFORMANCE	Modulation range of the compressor	%	15 to 100				
	Heating power output ² , B0W35	kW	4,0 to 22,8				
	COP ² , B0W35	-	4,9				
	Active cooling power output ² , B35W7	kW	-	4,2 to 22,0			
	EER ² , B35W7	-	-	5,3			
	Max. DHW temperature without / with support ⁵	°C	63 / 70				
	Noise power emission level ⁶	db	35 to 46				
	Energy label / rjs / SCOP W35 average climate control	-	A+++ / 184% / 4,71				
	Energy label / rjs / SCOP W55 average climate control	-	A++ / 147% / 3,77				
	OPERATION LIMITS	Distribution / Set heating outlet temperature range	°C	10 to 60 / 20 to 60			
Distribution / Set cooling outlet temperature range		°C	5 to 35 / 7 to 25				
Brine inlet temperature range in heating applications		°C	-25 to 35				
Brine inlet temperature range in cooling applications		°C	10 to 60				
Minimum / Maximum refrigerant circuit pressure		bar	2 / 45				
Production / Pre-load circuit pressure		bar	0,5 to 3,0 / 1,5				
Brine / Pre-load circuit pressure		bar	0,5 to 3,0 / 0,7				
Volume / Max. DHW storage tank pressure (ecoGEO+ C)		l / bar	165 / 8				
WORKING FLUIDS	R410A Refrigerant load without HTR / with HTR	kg	1,4		1,5		
	Compressor oil type / load	kg	POE / 1,18				
CONTROL ELECTRICAL DATA	1/N/PE 230 V / 50-60 Hz ⁸	-	✓				
	Maximum recommended external protection ⁹	-	C16A				
	Transformer primary circuit fuse	A	0,5				
ELECTRICAL DATA: SINGLE-PHASE	Transformer secondary circuit fuse	A	2,5				
	1/N/PE 230 V / 50-60 Hz ⁸	-	✓				
	Maximum recommended external protection ⁹	-	C32A				
	Maximum consumption ² , B0W35	kW / A	5,5 / 23,9				
	Maximum consumption ² , B0W55	kW / A	5,5 / 23,9				
ELECTRICAL DATA: THREE-PHASE	Minimum / Maximum starting current ⁷	A	2,6 / 12,5				
	Correction of cosine Ø	-	0,96 / 1				
	3/N/PE 400 V / 50-60Hz ⁸	-	✓				
	Maximum recommended external protection ⁹	-	C16A				
	Maximum consumption ² , B0W35	kW / A	6,0 / 8,7				
DIMENSIONS/WEIGHT	Maximum consumption ² , B0W55	kW / A	6,0 / 8,7				
	Minimum / Maximum starting current ⁷	A	0,9 / 4,2				
DIMENSIONS/WEIGHT	Correction of cosine Ø	-	0,96 / 1				
	Height x width x depth	mm	ecoGEO+ B: 1058x600x710 · ecoGEO+ C: 1851x600x720				
DIMENSIONS/WEIGHT	Empty weight (without assembly)	kg	B 185 · C 247	B 193 · C 255	B 185 · C 247	B 193 · C 255	

1. Air source/Hybrid source by replacing/combining the ground source circuit by/with one or more ecoGEO+ AU. Consult the ecoGEO+ AU manual for more detailed information.
 2. In compliance with EN 14511, this includes the consumption of the circulation pumps and the compressor driver.
 3. Considering brine and production flow rates in compliance with EN 14511.
 4. Considering a heat slope from 20°C to 50°C in absence of consumption.
 5. Considering support provided by the emergency electrical heater or the HTR system. Maximum DHW temperature with the HTR system can be limited by
 6. In compliance with EN 12102.
 7. Starting current depends on the working conditions of the hydraulic circuits.
 8. The admissible voltage range for proper operation of the heat pump is ±10%.
 9. Maximum consumption can vary significantly according to working conditions, or if the compressor's operation range is restricted. Consult the technical service manual for more detailed information.
 10. Certification in process.

Dimensions and hydraulic connections

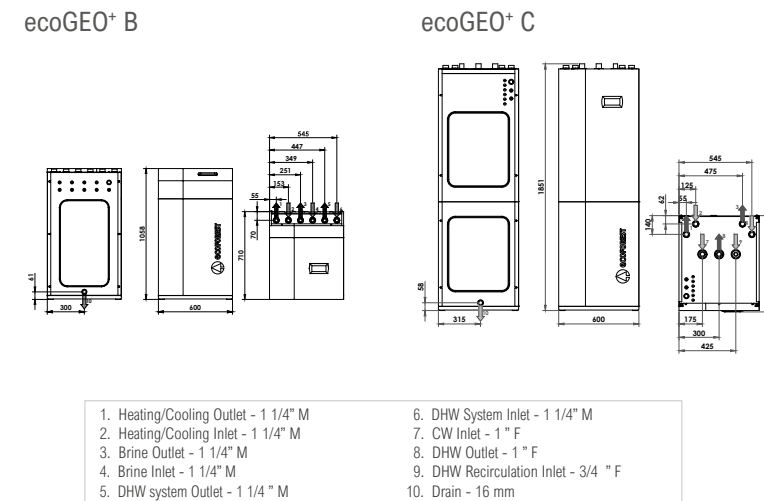

Operational chart

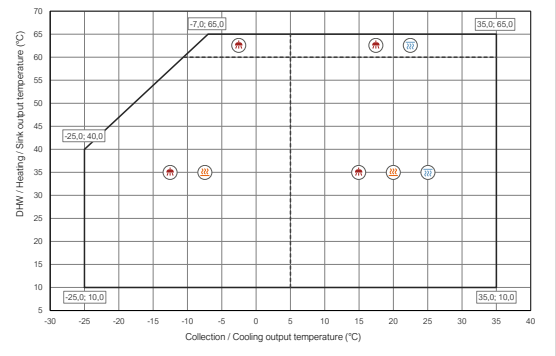

Installation management

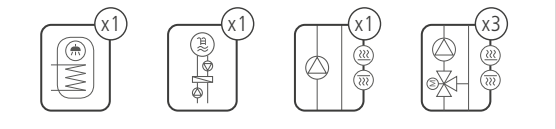

Performance curves

Thermal performance

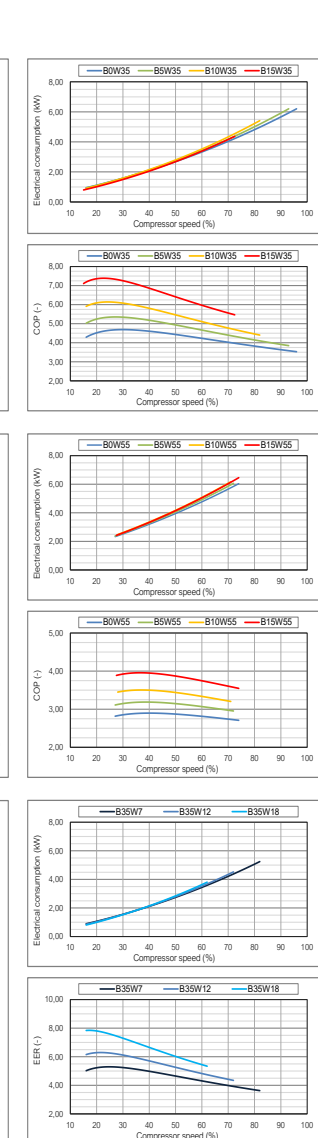
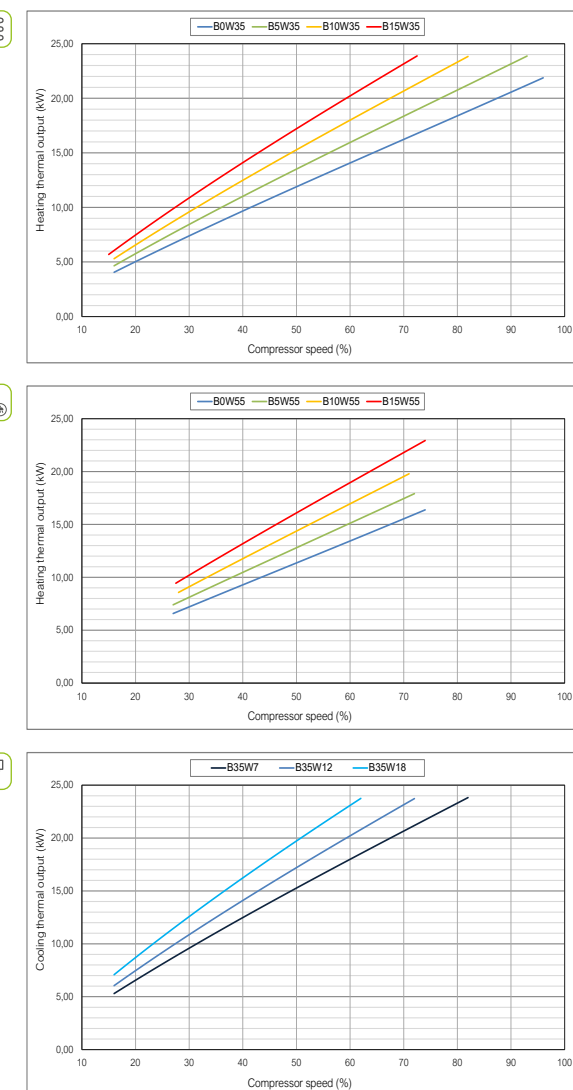

Hydraulic performance

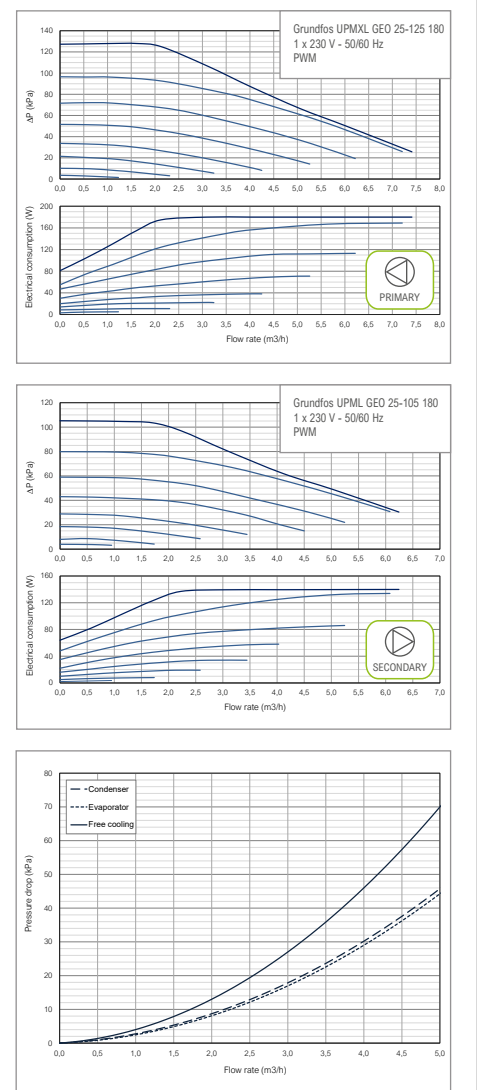

ecoGEO+ HP

High Power range



Power ranges

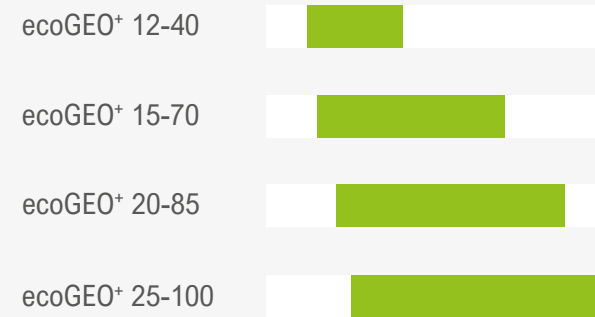

Cascade



Services



DHW



Heating



Cooling



Pool

Models

ecoGEO+ HP1

- DHW
- Heating
- Pool
- Free Cooling *

ecoGEO+ HP3

- DHW
- Heating
- Pool
- Free Cooling *
- Active Cooling

* External free cooling management

Inverter technology

Power ranges: 12-40 kW / 15-70 kW / 20-85 kW / 25-100 kW

Domestic hot water production

Heating and pool production

Integrated active cooling production

External passive (free) cooling production management

HTR technology for DHW production up to 75°C and simultaneous production of several services

Internet connection through the ecoSMART Easynet

Integrated photovoltaic hybridisation

Simultaneous heating and cooling production

Hybrid source management through ecoSMART e-source

Cascade management up to 6 units through cascade manager ecoSMART Supervisor

Three-phase (400V) power supply



Collection system



Ground



Open loop



Air



Hybrid



ecoGEO+ HP 12-40

- Modulating thermal power control within a wide range (25-100%) and modulating flow rate control of both brine and production circuits (20-100%).
- Inverter technology and scroll compressor.
- Integrated management of up to 5 different emission temperatures, 2 buffer tanks (heating and cooling), 1 DHW tank, 1 pool and hourly control of DHW recirculation.
- Management of aérothermal collection modulating units, in case of air source or hybrid configurations by means of the ecoSMART e-source.
- Integrated management of external On/Off or modulating auxiliary systems, such as electrical heaters, On/Off boilers or modulating boilers.
- Management of cascade systems up to 6 units by means of the ecoSMART Supervisor.
- Integrated management of simultaneous cooling/heating systems according to scheme.
- Free cooling (Passive cooling) management.
- Integrated active cooling in models 3.
- Three-phase version available.
- Integrated photovoltaic hybridisation.
- Integrated energy meters to measure the electrical consumption, the heating/cooling thermal power, the COP and the monthly and annual SPF.

SPECIFICATIONS ecoGEO+ HP 12-40		UNITS	HP1	HP3
APPLICATION	Place of installation	-	Indoors	
	Type of brine system ¹	-	Ground source / Air source / Hybrid source	
	DHW with external tank	-	✓	✓
	Heating and Pool	-	✓	✓
	External Passive cooling management	-	✓	✓
	Integrated Active cooling	-	-	✓
PERFORMANCE	Modulation range of the compressor	%	25 to 100	
	Heating power output ¹ , B0W35	kW	10,7 to 44,6	
	COP ¹ , B0W35	-	4,6	
	Active cooling power output ¹ , B35W7	kW	-	11,3 to 45,8
	EER ¹ , B35W7	-	-	4,4
	Max. DHW temperature without / with support	°C	60 / 70	
	Noise power emission level ³	db	53 to 71	
	Energy label / ηs / SCOP W35 average climate control	-	A+++ / 194% / 4,94	
	Energy label / ηs / SCOP W55 average climate control	-	A++ / 148% / 3,81	
	Distribution / Set heating outlet temperature range ²	°C	10 to 60 / 20 to 60	
OPERATION LIMITS	Distribution / Set cooling outlet temperature range ²	°C	5 to 35 / 7 to 25	
	Brine inlet temperature range in heating applications ²	°C	-20 to 35	
	Brine inlet temperature range in cooling applications ²	°C	10 to 60	
	Minimum / Maximum refrigerant circuit pressure	bar	2 / 45	
	Production / Pre-load circuit pressure	bar	0,5 to 5,0	
	Brine / Pre-load circuit pressure	bar	0,5 to 5,0	
WORKING FLUIDS	R410A Refrigerant load	kg	4,1	4,4
	Compressor oil type / load	kg	POE 160SZ / 3,8	
	Nominal primary flow rate, B0W35 (ΔT = 3 °C)	l/h	2405 to 9830	
	Nominal secondary flow rate, B0W35 (ΔT = 5 °C)	l/h	1845 to 7685	
CONTROL ELECTRICAL DATA	1/N/PE 230 V / 50-60 Hz ⁵	-	✓	
	Maximum recommended external protection ⁷	-	C1A	
	Transformer primary circuit fuse	A	0,63	
	Transformer secondary circuit fuse	A	4,0	
ELECTRICAL DATA: THREE-PHASE	3/N/PE 400 V / 50-60Hz ⁵	-	✓	
	Maximum recommended external protection ⁷	-	C40A	
	Maximum consumption ² , B0W35	kW / A	10,9 / 17,7	
	Maximum consumption ² , B0W55	kW / A	15,5 / 24,6	
	Maximum consumption	kW / A	18,1 / 28,6	
	Minimum / Maximum starting current ⁴	A	5,6 / 9,0	
DIMENSIONS/WEIGHT	Correction of cosine Ø	-	0,96 / 1	
	Height x width x depth	mm	1063x870x785	
	Empty weight (without assembly)	kg	295	307

1. In compliance with EN 14511, this includes the consumption of the circulation pumps and the compressor driver.
 2. With variable speed circulating pumps, managed by the ecoGEO+ HP heat pump.
 3. According to EN 12102.
 4. Starting current depends on working condition of the hydraulic circuits.
 5. The admissible voltage range for proper operation of the heat pump is ±10%.
 6. Maximum consumption can vary significantly according to working conditions, or if the compressor's range of operation is restricted.
 7. External protection exclusively regarding the ecoGEO+ heat pump controller electrical consumption. This protection should be updated in case of using the controller single-phase electrical supply to wire other equipments depending on the features of such equipments.
 8. In case of air source or hybrid source configuration, it is required to combine the ecoGEO+ HP heat pump with the ecoSMART e-source.
 Note: primary circuit and secondary circuit circulation pumps not included.

Dimensions and hydraulic connections

ecoGEO+ HP

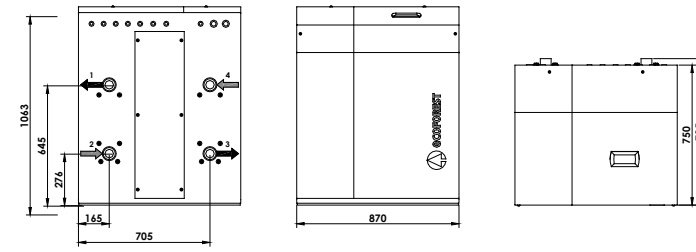

1. Secondary Outlet - 2" M
2. Secondary Inlet - 2" M
3. Primary Outlet - 2" M
4. Primary Inlet - 2" M

Operational chart

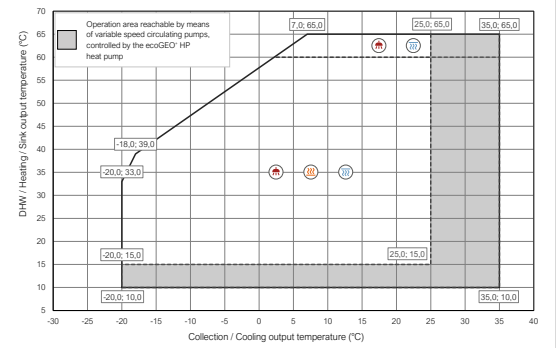

Installation management

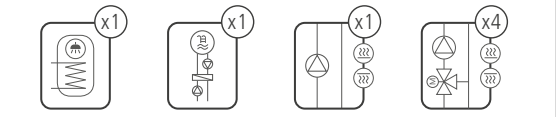

Performance curves

Thermal performance

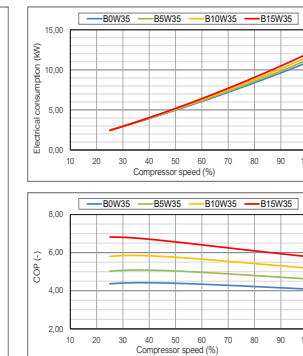
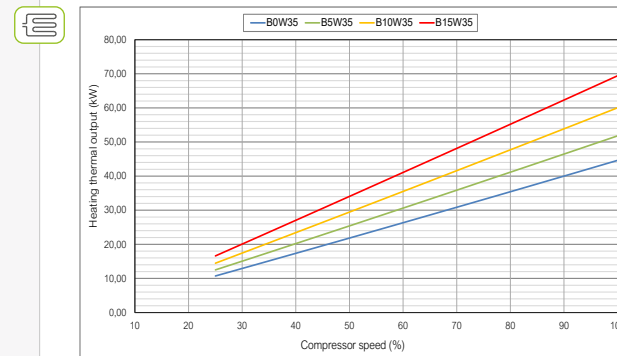

Hydraulic performance

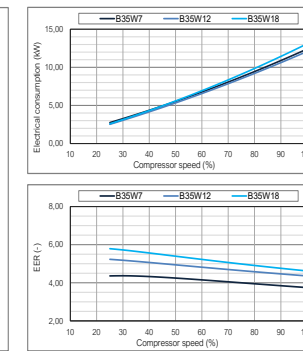
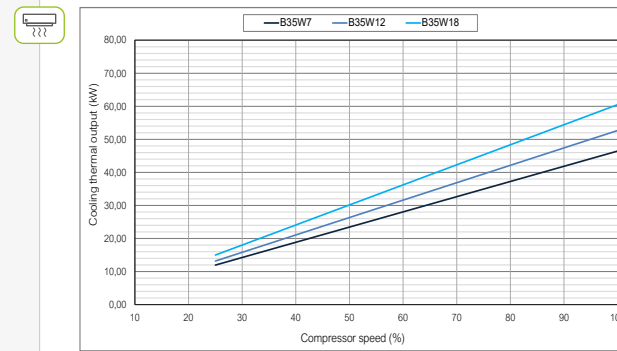
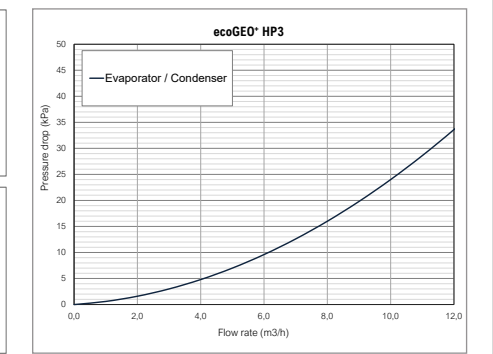
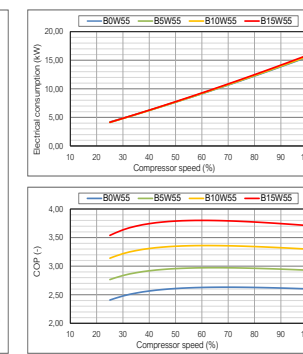
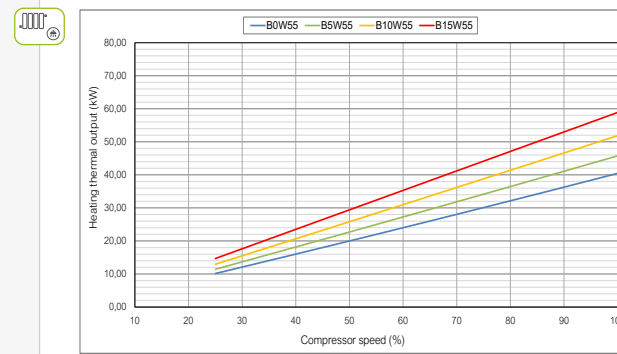
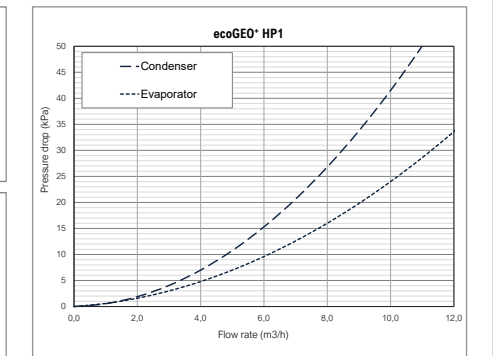

ecoGEO+ HP 15-70

- Modulating thermal power control within a wide range (25-100%) and modulating flow rate control of both brine and production circuits (20-100%).
- Inverter technology and scroll compressor.
- Integrated management of up to 5 different emission temperatures, 2 buffer tanks (heating and cooling), 1 DHW tank, 1 pool and hourly control of DHW recirculation.
- Management of aérothermal collection modulating units, in case of air source or hybrid configurations by means of the ecoSMART e-source.
- Integrated management of external On/Off or modulating auxiliary systems, such as electrical heaters, On/Off boilers or modulating boilers.
- Management of cascade systems up to 6 units by means of the ecoSMART Supervisor.
- Integrated management of simultaneous cooling/heating systems according to scheme.
- Free cooling (Passive cooling) management.
- Integrated active cooling in models 3.
- Three-phase version available.
- Integrated photovoltaic hybridisation.
- Integrated energy meters to measure the electrical consumption, the heating/cooling thermal power, the COP and the monthly and annual SPF.

SPECIFICATIONS ecoGEO+ HP 15-70		UNITS	HP1	HP3
APPLICATION	Place of installation	-	Indoors	
	Type of brine system ¹	-	Ground source / Air source / Hybrid source	
	DHW with external tank	-	✓	✓
	Heating and Pool	-	✓	✓
	External Passive cooling management	-	✓	✓
	Integrated Active cooling	-	-	✓
PERFORMANCE	Modulation range of the compressor	%	25 to 100	
	Heating power output ¹ , B0W35	kW	17,1 to 59,6	
	COP ¹ , B0W35	-	4,5	
	Active cooling power output ¹ , B35W7	kW	-	15,1 to 61,5
	EER ¹ , B35W7	-	-	4,5
	Max. DHW temperature without / with support	°C	60 / 70	
	Noise power emission level ³	db	53 to 71	
	Energy label / ηs / SCOP W35 average climate control	-	A+++ / 200% / 5,09	
	Energy label / ηs / SCOP W55 average climate control	-	A+++ / 152% / 3,90	
	OPERATION LIMITS	Distribution / Set heating outlet temperature range ²	°C	10 to 60 / 20 to 60
Distribution / Set cooling outlet temperature range ²		°C	5 to 35 / 7 to 25	
Brine inlet temperature range in heating applications ²		°C	-20 to 35	
Brine inlet temperature range in cooling applications ²		°C	10 to 60	
Minimum / Maximum refrigerant circuit pressure		bar	2 / 45	
Production / Pre-load circuit pressure		bar	0,5 to 5,0	
WORKING FLUIDS	Brine / Pre-load circuit pressure	bar	0,5 to 5,0	
	R410A Refrigerant load	kg	4,7	5,5
	Compressor oil type / load	kg	POE 160SZ / 4,1	
	Nominal primary flow rate, B0W35 (ΔT = 3 °C)	l/h	3230 to 13195	
CONTROL ELECTRICAL DATA	Nominal secondary flow rate, B0W35 (ΔT = 5 °C)	l/h	2465 to 10265	
	1/N/PE 230 V / 50-60 Hz ⁵	-	✓	
	Maximum recommended external protection ⁷	-	C1A	
	Transformer primary circuit fuse	A	0,63	
	Transformer secondary circuit fuse	A	4,0	
	ELECTRICAL DATA: THREE-PHASE	3/N/PE 400 V / 50-60Hz ⁵	-	✓
Maximum recommended external protection ⁷		-	C50A	
Maximum consumption ² , B0W35		kW / A	14,3 / 23,2	
Maximum consumption ² , B0W55		kW / A	20,4 / 32,3	
Maximum consumption		kW / A	23,7 / 37,0	
Minimum / Maximum starting current ⁴		A	7,5 / 11,8	
DIMENSIONS/WEIGHT	Correction of cosine Ø	-	0,96 / 1	
	Height x width x depth	mm	1063x870x785	
	Empty weight (without assembly)	kg	322	336

1. In compliance with EN 14511, this includes the consumption of the circulation pumps and the compressor driver.
 2. With variable speed circulating pumps, managed by the ecoGEO+ HP heat pump.
 3. According to EN 12102.
 4. Starting current depends on working condition of the hydraulic circuits.
 5. The admissible voltage range for proper operation of the heat pump is ±10%.
 6. Maximum consumption can vary significantly according to working conditions, or if the compressor's range of operation is restricted.
 7. External protection exclusively regarding the ecoGEO+ heat pump controller electrical consumption. This protection should be updated in case of using the controller single-phase electrical supply to wire other equipments depending on the features of such equipments.
 8. In case of air source or hybrid source configuration, it is required to combine the ecoGEO+ HP heat pump with the ecoSMART e-source.
 Note: primary circuit and secondary circuit circulation pumps not included.

Dimensions and hydraulic connections

ecoGEO+ HP

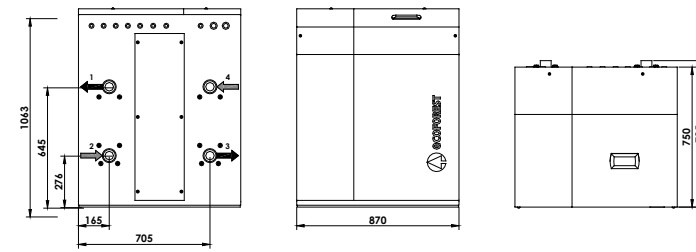

1. Secondary Outlet - 2" M
2. Secondary Inlet - 2" M
3. Primary Outlet - 2" M
4. Primary Inlet - 2" M

Operational chart

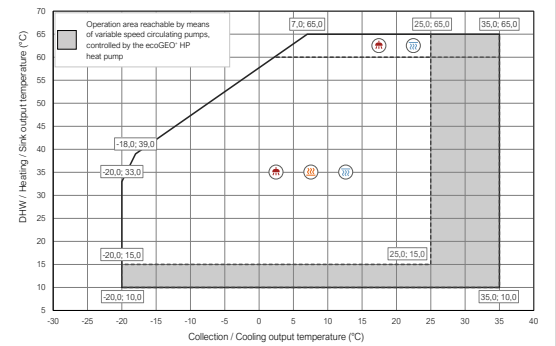

Installation management

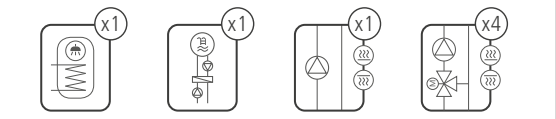

Performance curves

Thermal performance

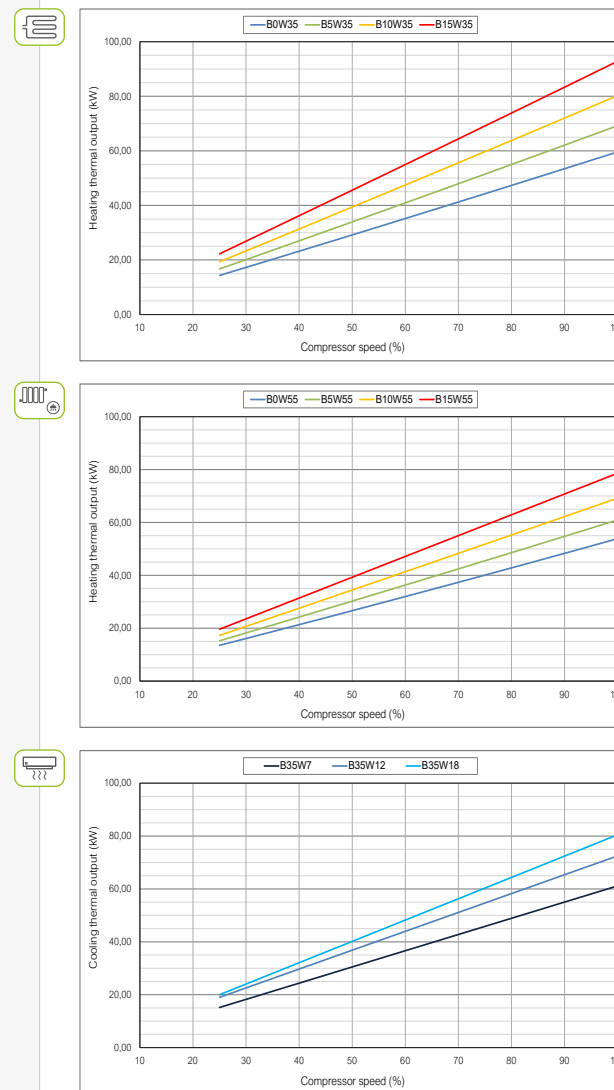

Hydraulic performance

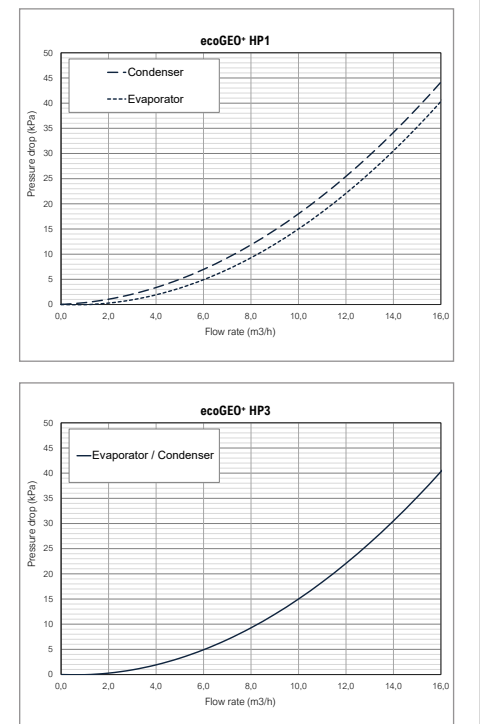

ecoGEO+ HP 20-85

- Modulating thermal power control within a wide range (25-100%) and modulating flow rate control of both brine and production circuits (20-100%).
- Inverter technology and scroll compressor.
- Integrated management of up to 5 different emission temperatures, 2 buffer tanks (heating and cooling), 1 DHW tank, 1 pool and hourly control of DHW recirculation.
- Management of athermal collection modulating units, in case of air source or hybrid configurations by means of the ecoSMART e-source.
- High Temperature Recovery system (HTR) for DHW production up to 70 °C without electrical support and simultaneous production of DHW and heating/cooling.
- Integrated management of external On/Off or modulating auxiliary systems, such as electrical heaters, On/Off boilers or modulating boilers.
- Management of cascade systems up to 6 units by means of the ecoSMART Supervisor.
- Integrated management of simultaneous cooling/heating systems according to scheme.
- Free cooling (Passive cooling) management.
- Integrated active cooling in models 3.
- Three-phase version available.
- Integrated photovoltaic hybridisation.
- Integrated energy meters to measure the electrical consumption, the heating/cooling thermal power, the COP and the monthly and annual SPF.

SPECIFICATIONS ecoGEO+ HP 20-85		UNITS	HP1	HP3
APPLICATION	Place of installation	-	Indoors	
	Type of brine system ¹	-	Ground source / Air source / Hybrid source	
	DHW with external tank	-	✓	✓
	Heating and Pool	-	✓	✓
	External Passive cooling management	-	✓	✓
	Integrated Active cooling	-	-	✓
PERFORMANCE	Modulation range of the compressor	%	25 to 100	
	Heating power output ¹ , B0W35	kW	21,5 to 86,5	
	COP ¹ , B0W35	-	4,6	
	Active cooling power output ¹ , B35W7	kW	-	21,4 to 73,7
	EER ¹ , B35W7	-	-	4,5
	Max. DHW temperature without / with support	°C	60 / 80	
	Noise power emission level ³	db	59 to 72	
	Energy label W35 with average climate control	-	A+++	
	Energy label W55 average climate control	-	A++	
	OPERATION LIMITS	Distribution / Set heating outlet temperature range ²	°C	10 to 60 / 20 to 60
Distribution / Set cooling outlet temperature range ²		°C	5 to 35 / 7 to 25	
Brine inlet temperature range in heating applications ²		°C	-20 to 35	
Brine inlet temperature range in cooling applications ²		°C	10 to 60	
Minimum / Maximum refrigerant circuit pressure		bar	2 / 45	
Production / Pre-load circuit pressure		bar	0,5 to 5,0	
WORKING FLUIDS	Brine / Pre-load circuit pressure	bar	0,5 to 5,0	
	R410A Refrigerant load	kg	10	
	Compressor oil type / load	kg	POE 160SZ / 7,7	
	Nominal primary flow rate, B0W35 ¹ (ΔT = 3 °C)	l/h	4612 to 18057	
CONTROL ELECTRICAL DATA	Nominal secondary flow rate, B0W35 ¹ (ΔT = 5 °C)	l/h	3572 to 14398	
	1/N/PE 230 V / 50-60 Hz ⁵	-	✓	
	Maximum recommended external protection ⁷	-	C1A	
	Transformer primary circuit fuse	A	0,63	
	Transformer secondary circuit fuse	A	4,0	
	ELECTRICAL DATA: THREE-PHASE	3/N/PE 400 V / 50-60Hz ⁵	-	✓
Maximum recommended external protection ⁷		-	C63A	
Maximum consumption ² , B0W35		kW / A	20,3 / 31,8	
Maximum consumption ² , B0W55		kW / A	29,6 / 45,1	
Maximum consumption		kW / A	33,7 / 52,9	
Minimum / Maximum starting current ⁴		A	10,8 / 16,7	
DIMENSIONS/WEIGHT	Correction of cosine Ø	-	0,96 / 1	
	Height x width x depth	mm	1074 x 1009 x 916	
	Empty weight (without assembly)	kg	450	465

1. In compliance with EN 14511, this includes the consumption of the circulation pumps and the compressor driver.
 2. With variable speed circulating pumps, managed by the ecoGEO+ HP heat pump.
 3. According to EN 12102.
 4. Starting current depends on working condition of the hydraulic circuits.
 5. The admissible voltage range for proper operation of the heat pump is ±10%.
 6. Maximum consumption can vary significantly according to working conditions, or if the compressor's range of operation is restricted.
 7. External protection exclusively regarding the ecoGEO+ heat pump controller electrical consumption. This protection should be updated in case of using the controller single-phase electrical supply to wire other equipments depending on the features of such equipments.
 8. In case of air source or hybrid source configuration, it is required to combine the ecoGEO+ HP heat pump with the ecoSMART e-source.
 Note: primary circuit and secondary circuit circulation pumps not included.

Dimensions and hydraulic connections

ecoGEO+ HP

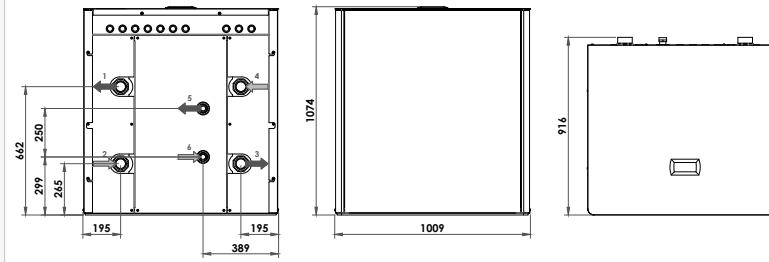

1. Secondary Outlet - 2 1/2" M
2. Secondary Inlet - 2 1/2" M
3. Primary Outlet - 2 1/2" M
4. Primary Inlet - 2 1/2" M
5. HTR Inlet - 1 1/4" M
6. HTR Outlet - 1 1/4" M

Operational chart

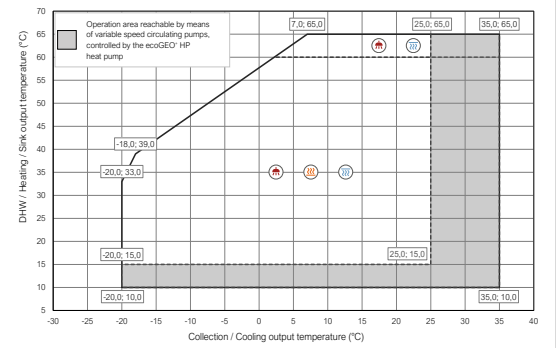

Installation management

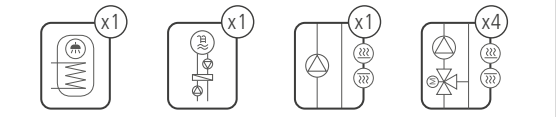

Performance curves

Thermal performance

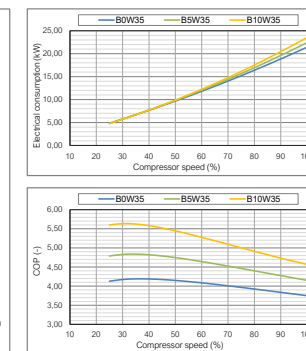
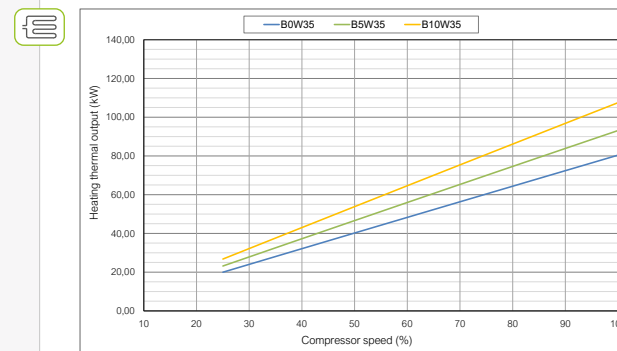

Hydraulic performance

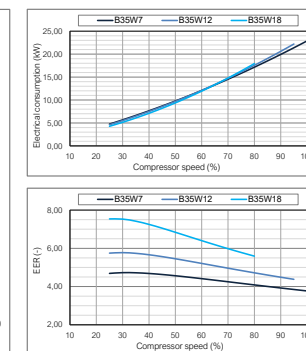
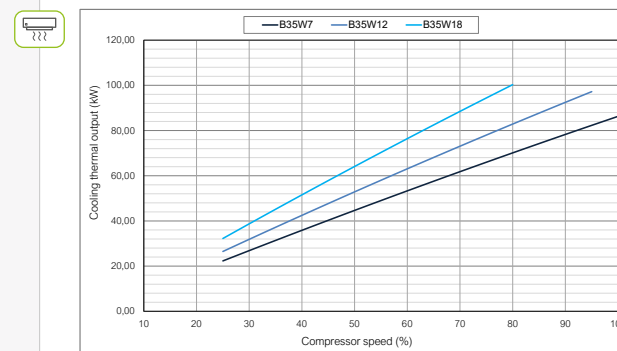
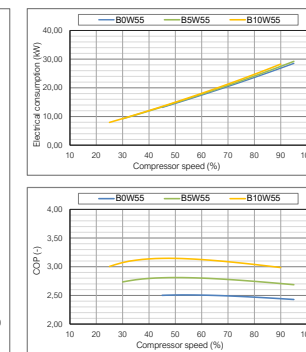
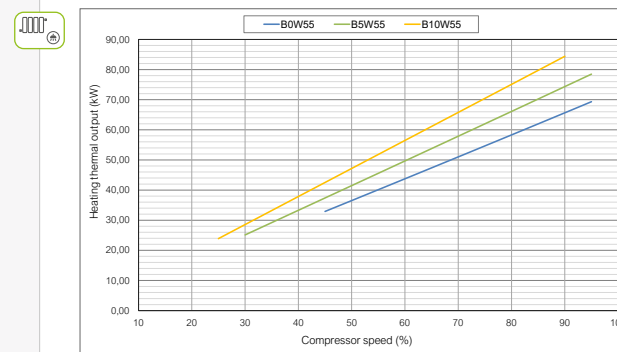
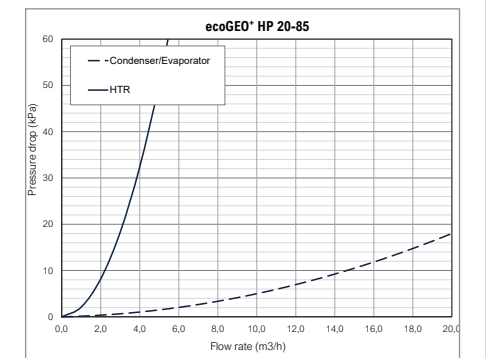

ecoGEO+ HP 25-100

- Modulating thermal power control within a wide range (25-100%) and modulating flow rate control of both brine and production circuits (20-100%).
- Inverter technology and scroll compressor.
- Integrated management of up to 5 different emission temperatures, 2 buffer tanks (heating and cooling), 1 DHW tank, 1 pool and hourly control of DHW recirculation.
- Management of aérothermal collection modulating units, in case of air source or hybrid configurations by means of the ecoSMART e-source.
- Integrated management of external On/Off or modulating auxiliary systems, such as electrical heaters, On/Off boilers or modulating boilers.
- Management of cascade systems up to 6 units by means of the ecoSMART Supervisor.
- Integrated management of simultaneous cooling/heating systems according to scheme.
- Free cooling (Passive cooling) management.
- Integrated active cooling in models 3.
- Three-phase version available.
- Integrated photovoltaic hybridisation.
- Integrated energy meters to measure the electrical consumption, the heating/cooling thermal power, the COP and the monthly and annual SPF.

SPECIFICATIONS ecoGEO+ HP 25-100		UNITS	HP1	HP3
APPLICATION	Place of installation	-	Indoors	
	Type of brine system ¹	-	Ground source / Air source / Hybrid source	
	DHW with external tank	-	✓	✓
	Heating and Pool	-	✓	✓
	External Passive cooling management	-	✓	✓
	Integrated Active cooling	-	-	✓
PERFORMANCE	Modulation range of the compressor	%	25 to 100	
	Heating power output ¹ , B0W35	kW	21,1 to 86,7	
	COP ¹ , B0W35	-	4,5	
	Active cooling power output ¹ , B35W7	kW	-	22,3 to 90,3
	EER ¹ , B35W7	-	-	4,6
	Max. DHW temperature without / with support	°C	60 / 70	
	Noise power emission level ³	db	59 to 72	
	Energy label / ηs / SCOP W35 average climate control	-	A+++ / 199% / 5,08	
OPERATION LIMITS	Energy label / ηs / SCOP W55 average climate control	-	A++ / 147% / 3,78	
	Distribution / Set heating outlet temperature range ²	°C	10 to 60 / 20 to 60	
	Distribution / Set cooling outlet temperature range ²	°C	5 to 35 / 7 to 25	
	Brine inlet temperature range in heating applications ²	°C	-20 to 35	
	Brine inlet temperature range in cooling applications ²	°C	10 to 60	
	Minimum / Maximum refrigerant circuit pressure	bar	2 / 45	
	Production / Pre-load circuit pressure	bar	0,5 to 5,0	
	Brine / Pre-load circuit pressure	bar	0,5 to 5,0	
WORKING FLUIDS	R410A Refrigerant load	kg	8,5	9,1
	Compressor oil type / load	kg	POE 160SZ / 7,7	
	Nominal primary flow rate, B0W35 ¹ (ΔT = 3 °C)	l/h	4765 to 19360	
	Nominal secondary flow rate, B0W35 ¹ (ΔT = 5 °C)	l/h	3625 to 14935	
CONTROL ELECTRICAL DATA	1/N/PE 230 V / 50-60 Hz ⁵	-	✓	
	Maximum recommended external protection ⁷	-	C1A	
	Transformer primary circuit fuse	A	0,63	
	Transformer secondary circuit fuse	A	4,0	
ELECTRICAL DATA: THREE-PHASE	3/N/PE 400 V / 50-60Hz ⁵	-	✓	
	Maximum recommended external protection ⁷	-	C63A	
	Maximum consumption ² , B0W35	kW / A	20,3 / 31,8	
	Maximum consumption ² , B0W55	kW / A	29,6 / 45,1	
	Maximum consumption	kW / A	33,7 / 52,9	
	Minimum / Maximum starting current ⁴	A	10,8 / 16,7	
DIMENSIONS/WEIGHT	Correction of cosine Ø	-	0,96 / 1	
	Height x width x depth	mm	1063x950x886	
	Empty weight (without assembly)	kg	450	465

1. In compliance with EN 14511, this includes the consumption of the circulation pumps and the compressor driver.
 2. With variable speed circulating pumps, managed by the ecoGEO+ HP heat pump.
 3. According to EN 12102.
 4. Starting current depends on working condition of the hydraulic circuits.
 5. The admissible voltage range for proper operation of the heat pump is ±10%.
 6. Maximum consumption can vary significantly according to working conditions, or if the compressor's range of operation is restricted.
 7. External protection exclusively regarding the ecoGEO+ heat pump controller electrical consumption. This protection should be updated in case of using the controller single-phase electrical supply to wire other equipments depending on the features of such equipments.
 8. In case of air source or hybrid source configuration, it is required to combine the ecoGEO+ HP heat pump with the ecoSMART e-source.
 Note: primary circuit and secondary circuit circulation pumps not included.

Dimensions and hydraulic connections

ecoGEO+ HP

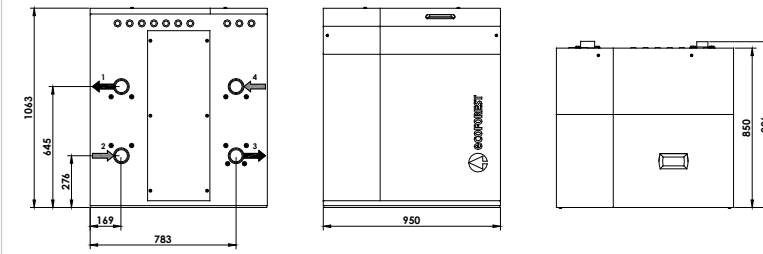

1. Secondary Outlet - 2 1/2" M
2. Secondary Inlet - 2 1/2" M
3. Primary Outlet - 2 1/2" M
4. Primary Inlet - 2 1/2" M

Operational chart

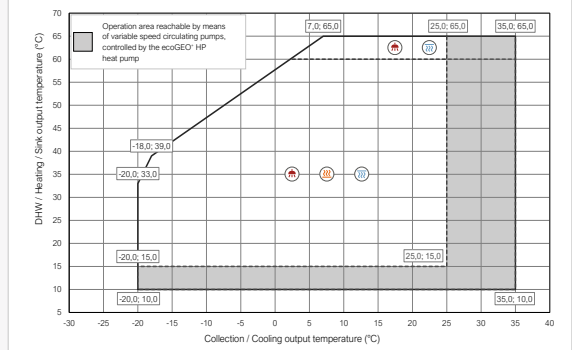

Installation management

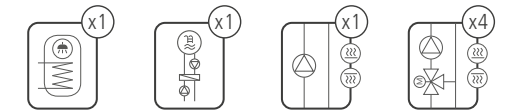

Performance curves

Thermal performance

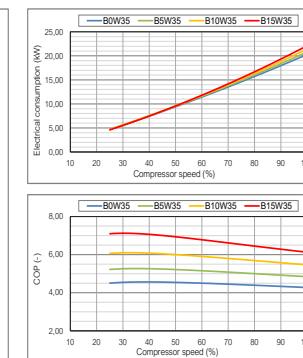
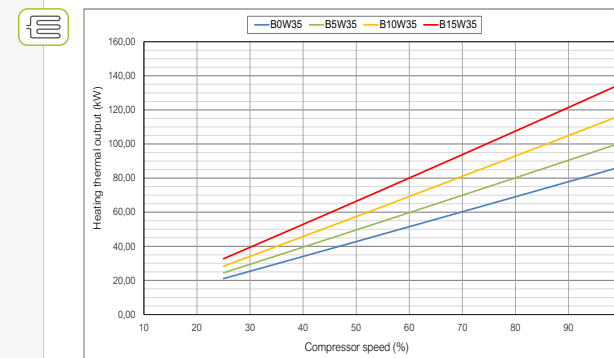

Hydraulic performance

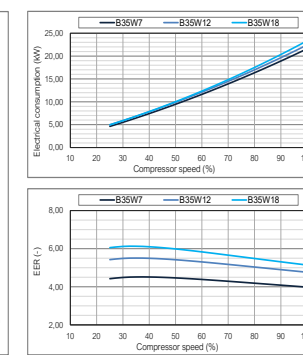
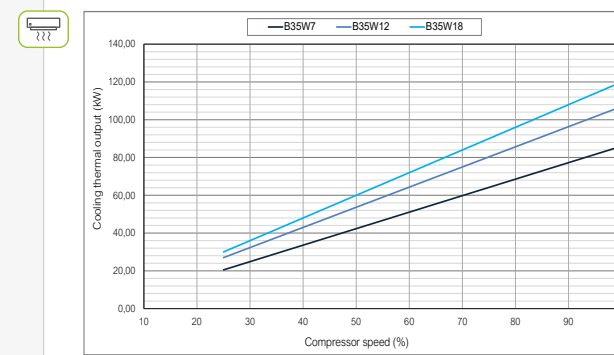
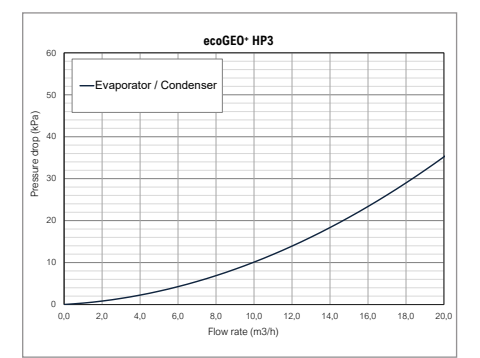
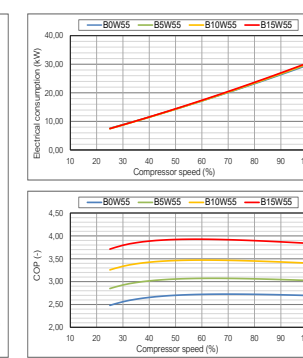
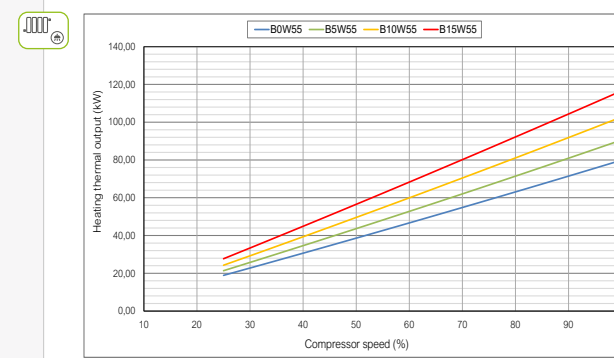
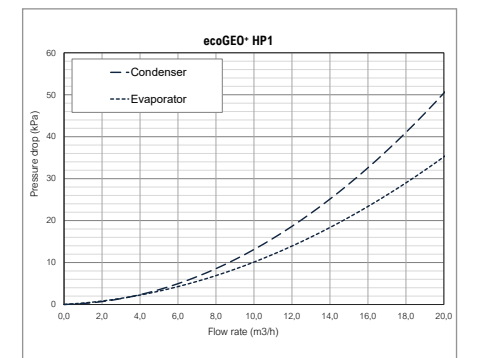

ecoGEO+ & AU

Water-to-water air source heat pumps



ecoGEO+ & AU

Inverter water-to-water air source, a unique solution

The ecoGEO+ range is the Ecoforest range of water-to-water heat pumps. These heat pumps, both domestic and high power, are compatible with aérothermal collection systems and even with hybrid aérothermal-geothermal collection systems. Likewise, they are also capable of offering all the services required in a HVAC system in an integrated way: DHW, Heating, Pool and Active Cooling.



All ecoGEO+ heat pumps make use of Inverter technology, which allows them to modulate their power in order to adapt to the thermal demands of the installation with the highest efficiency. This translates into a very considerable reduction in electrical consumption and great savings. In addition, this air source solution presents a series of considerable advantages compared to conventional aérothermal units: a lower acoustic emission level, a unique defrost system that results in higher seasonal performance, and an easier installation. Thanks to the technology and control strategies developed by Ecoforest, the installation of ecoGEO+ heat pumps also becomes simpler, more compact and cheaper than those of other heat pumps on the market, since it allows to dispense with certain components that would be necessary in traditional heat pump installations.

ecoGEO+ Basic/Compact & AU

Residential range

Power ranges

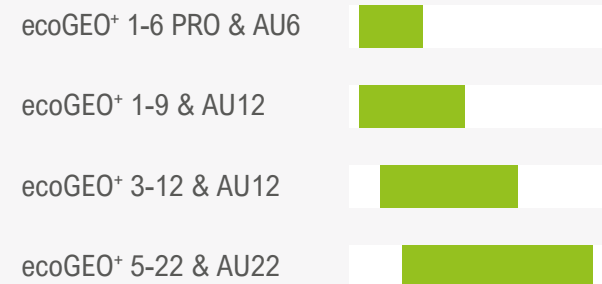

Cascade

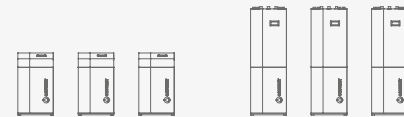

Services



DHW



Heating



Cooling



Pool

Models

ecoGEO+ B2/C2 & AU

DHW
Heating
Pool

ecoGEO+ B4/C4 & AU

DHW
Heating
Pool
Active Cooling

165 l

- Inverter technology
- Power ranges: 1-6 kW / 1-9 kW / 3-12 kW / 5-22 kW
- Domestic hot water production
- Heating and pool production
- Integrated active cooling production
- Modulating speed hydraulic aérothermal unit
- Internet connection through the ecoSMART Easynet
- Integrated photovoltaic hybridisation
- HTR technology for DHW production up to 70°C and simultaneous production of several services
- Natural refrigerant used in ecoGEO+ PRO models allowing DHW production temperature up to 75°C
- Integrated cascade management up to 3 units
- Single-phase (230V) or three-phase (400V) power supply

Exclusive performances



ecoGEO+ defrost system



Minimum sound level



Limitless layout



Greater lifespan



Outdoor aerothermal units

AU6 / AU12 / AU22

- Outdoor aerothermal units.
- Compatibles with ecoGEO+ B2/C2/B4/C4 models.
- Modulating collection thermal power control by means of the modulation of the fan speed (25-100%) and the modulation of the flow rate control of the brine circulation pump (20-100%).
- Exclusively hydraulic air source system allowing to replace a geothermal collection system by an aerothermal or a hybrid geothermal-aerothermal system.
- ecoGEO+ defrost system: defrosting without starting the compressor or activating electrical support systems.
- Working condition as collection system as well as dissipation system.
- Enhanced lifespan of the heat pump, which is placed indoors, compared to outdoor conventional monobloc or biblock units.
- Selection of the defrosting energy source: the ecoGEO+ control strategies allow to select the energy source for defrosting cycles depending of the installation features (DHW tank, heating buffer tank, pool, ...).

SPECIFICATIONS AU		UNITS	AU6	AU12	AU22
COMPATIBILITY AND DIMENSIONING	ecoGEO+ compatible models ¹	-	B2 / C2 / B4 / C4		
	Aerothermal collection with ecoGEO+ 1-6 kW PRO	-	✓	-	-
	Aerothermal collection with ecoGEO+ 1-9 kW	-	-	✓	-
	Aerothermal collection with ecoGEO+ 3-12 kW	-	-	✓	-
	Aerothermal collection with ecoGEO+ 5-22 kW	-	-	✓	✓
	Hybrid ground-air collection with ecoGEO+ 3-12 kW	-	-	✓	-
DEFROSTING	ecoGEO+ defrosting system ²	-	Source selection: DHW / Heating / Pool		
	Defrosted water volume per defrosting cycle	l	3	6	12
OPERATION LIMITS	Minimum / Maximum outdoor temperature	°C	-12 / 42		
	Minimum / Maximum working fluid temperature	°C	-18 / 55		
WORKING FLUIDS	Recommended working fluid ³	-	Water-propylene glycol mixture		
	Freezing temperature ⁴	°C	-25		
	Filling volume	l	6	19	33
	Maximum pressure	bar	6		
SOUND LEVEL	Nominal air flow rate	m ³ /h	2721	3309	6618
	Sound pressure level ⁵ (L _{PA}) - 2,5 m	dB(A)	52,6	53,1	56,1
	Sound pressure level ⁵ (L _{PA}) - 5 m	dB(A)	46,5	47,0	50,0
	Sound pressure level ⁵ (L _{PA}) - 10 m	dB(A)	40,5	41,0	44,0
ELECTRICAL DATA: SINGLE-PHASE	1/N/PE 230 V / 50-60 Hz ⁶	-	✓		
	Number of fans	-	1	1	2
HYDRAULIC CONNECTIONS	Maximum consumption	W / A	154 / 1,36	163 / 1,34	326 / 2,68
	Correction of cosine Ø	-	0,96 / 1		
	Working fluid inlet and outlet	-	G1 " M	G1 1/2 " M	G1 1/2 " M
DIMENSIONS AND WEIGHT	Drain diameter	mm	15		
	Height x width x depth	mm	670x790x520	900x1000x600	903x1800x600
	Fan diameter	mm	400	450	
	Nozzle diameter	mm	540		
Empty weight (without assembly)	kg	54	92	175	

1. Air source/Hybrid source by replacing/combining the ground source circuit by/with one or more ecoGEO+ AU. Consult the ecoGEO+ AU manual for more detailed information.
 2. Compressor turned off. Defrosting cycle by means of the thermal energy directly taken from the DHW tank, heating tank or pool. Compatible with the ecoGEO+ B2/B4/C2/C4 heat pump models.
 3. Consult local regulations before selecting the antifreeze for the working fluid mixture.
 4. Adapt the freezing temperature to the type of installation and the location climatic conditions and configure the corresponding protections. Prepare the antifreeze-water mixture in the right proportions depending on the required freezing temperature.
 5. Sound pressure level calculated in compliance with UNE-EN-ISO 3746:2010, maximum fan speed conditions in default configuration settings.
 6. Admissible voltage for the correct operation of the unit: ±10%.

Dimensions and hydraulic connections

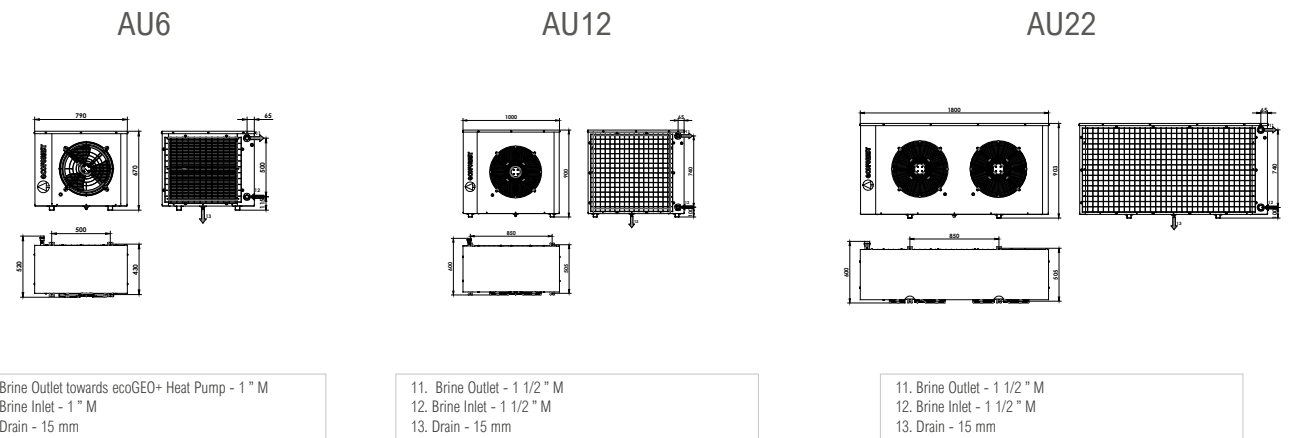

Layout and pressure drop

Hydraulic configurations

ecoGEO+ B/C PRO & AU

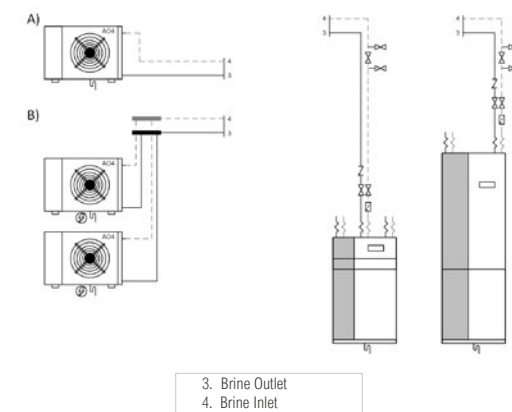

ecoGEO+ B/C & AU

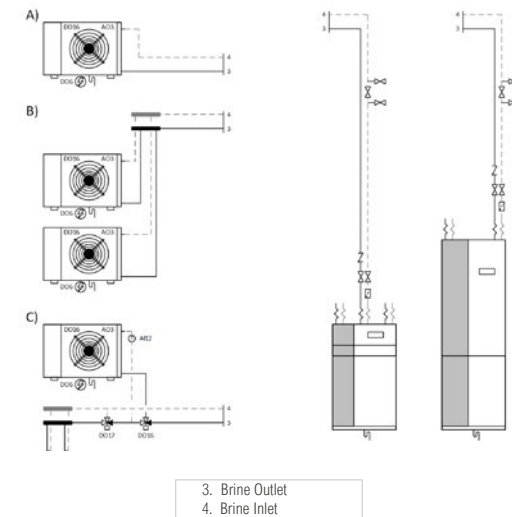

Service areas

Single AU

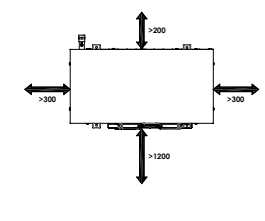

Several AUs in parallel

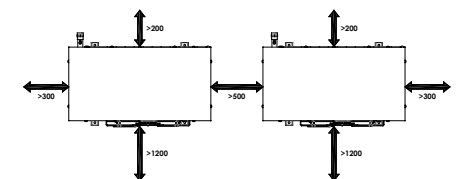

Pressure Drops

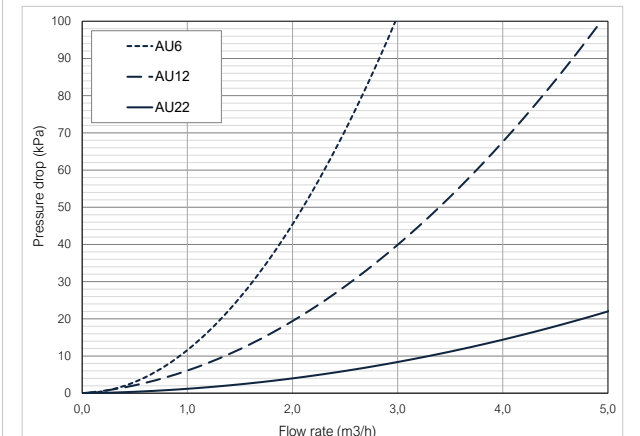

ecoGEO+ B/C 1-6 PRO & AU6

- Modulating thermal power control within a wide range (12,5-100%) and modulating flow rate control of both brine and production circuits (20-100%).
- Natural refrigerant R290 : GWP 3.
- Inverter technology.
- Compact design including brine and production circulation pumps, brine and production expansion vessels (8l and 12l respectively), brine and production safety valves and DHW three-way valve.
- Integrated management of up to 2 different emission temperatures, 2 buffer tanks (heating and cooling), 1 DHW tank, 1 pool and hourly control of DHW recirculation.
- Integrated management of aerothermal collection modulating units, in case of air source or hybrid configurations.
- Integrated management of external On/Off or modulating auxiliary systems, such as electrical heaters, On/Off boilers or modulating boilers.
- Exclusive defrosting system.
- Integrated active cooling in models 4.
- Single-phase version available.
- Integrated photovoltaic hybridisation.
- Integrated energy meters to measure the electrical consumption, the heating/cooling thermal power, the COP and the monthly and annual SPF.

SPECIFICATIONS ecoGEO+ B/C 1-6 PRO & AU6		UNITS	B2/C2	B4/C4
APPLICATION	Place of installation	-	Indoors: ecoGEO+ 1-6 PRO - Outdoors: AU6	
	Type of brine system ¹	-	Air source / Hybrid source	
	DHW, Heating and Pool	-	✓	✓
	High Temperature Recovery (HTR) system option	-	-	-
	Integrated Active cooling	-	-	✓
	Integrated ecoGEO+ defrosting system	-	✓	✓
PERFORMANCE	Modulation range of the compressor	%	12,5 to 100	
	Heating power output ² , A7W35	kW	0,5 to 5,6	
	COP ² , A7W35	-	4,0	
	Active cooling power output ² , A35W7	kW	-	0,8 to 5,0
	EER ² , A35W7	-	-	3,5
	Max. DHW temperature without / with support ⁵	°C	75 / 80	
	Noise power emission level ⁶	db	33 to 44	
OPERATION LIMITS	Energy label / rjs / SCOP W35 average climate control	-	A++ / 169% / 4,33	
	Energy label / rjs / SCOP W55 average climate control	-	A++ / 135% / 3,48	
	Distribution / Set heating outlet temperature range	°C	10 to 75 / 20 to 75	
	Distribution / Set cooling outlet temperature range	°C	5 to 35 / 7 to 25	
	Brine inlet temperature range in heating applications	°C	-25 to 35	
	Brine inlet temperature range in cooling applications	°C	10 to 75	
WORKING FLUIDS	Minimum / Maximum refrigerant circuit pressure	bar	0,5 / 32	
	Production / Pre-load circuit pressure	bar	0,5 a 3,0 / 1,5	
	Brine / Pre-load circuit pressure	bar	0,5 a 3,0 / 0,7	
	Volume / Max. DHW storage tank pressure (ecoGEO+ C)	l / bar	165 / 8	
	R290 Refrigerant load	kg	0,15	
CONTROL ELECTRICAL DATA	Compressor oil type / load	kg	PZ46M / 0,3	
	1/N/PE 230 V / 50-60 Hz ⁸	-	✓	
	Transformer primary circuit fuse	A	0,5	
	Transformer secondary circuit fuse	A	2,5	
ELECTRICAL DATA: SINGLE-PHASE	1/N/PE 230 V / 50-60 Hz ⁸	-	✓	
	Maximum recommended external protection ⁹	-	C16A	
	Maximum consumption ² , A7W35	kW / A	1,6 / 6,8	
	Maximum consumption ² , A7W55	kW / A	2,0 / 8,6	
	Minimum / Maximum starting current ⁷	A	0,6 / 1,8	
DIMENSIONS/WEIGHT	Correction of cosine Ø	-	0,96 / 1	
	Height x width x depth	mm	ecoGEO+ B: 1058x550x602 · ecoGEO+ C: 1851x600x720 / AU6: 670x790x520	
	Empty weight (without assembly)	kg	ecoGEO+ B: 133 · ecoGEO+ C: 194 / AU6: 54	

1. Air source by replacing the ground source circuit by one or more ecoGEO+ AU air units. Consult the ecoGEO+ AU aerothermal units manual for more detailed information.
 2. In compliance with EN 14511, this includes the consumption of the circulation pumps and the compressor driver.
 3. Considering brine and production flow rates in compliance with EN 14511.
 4. Considering a heat slope from 20°C to 50°C in absence of consumption.
 5. Considering support provided by the emergency electrical heater.
 6. In compliance with EN 12102.
 7. Starting current depends on the working conditions of the hydraulic circuits.
 8. The admissible voltage range for proper operation of the heat pump is ±10%.
 9. Maximum consumption can vary significantly according to working conditions, or if the compressor's operation range is restricted. Consult the technical service manual for more detailed information.
 10. Certification in process.

Dimensions and hydraulic connections

Indoor unit - ecoGEO+ B

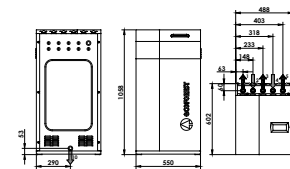

Indoor unit - ecoGEO+ C

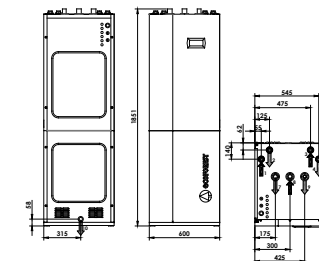

Outdoor unit - AU6

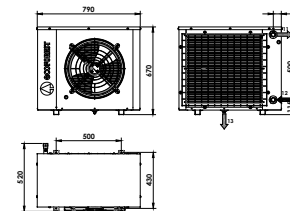

1. Heating/Cooling Outlet - 1" M
2. Heating/Cooling Inlet - 1" M
3. Brine Outlet - 1" M
4. Brine Inlet - 1" M
5. DHW System Outlet - 1" M
6. DHW System Inlet - 1" M
7. CW Inlet - 1" F
8. DHW Outlet - 1" F
9. DHW Recirculation Inlet - 3/4" F
10. Drain - 16 mm
11. AU Source Inlet - 1" M
12. AU Source Outlet - 1" M
13. AU Drain - 15 mm

Operational chart

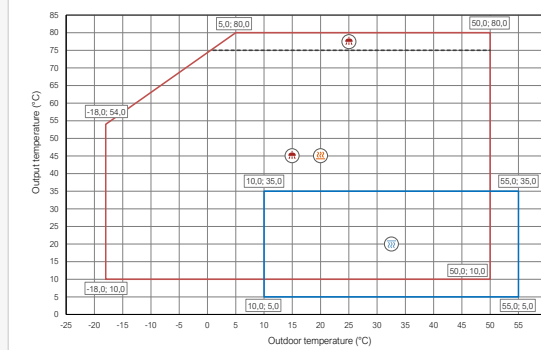

Installation management

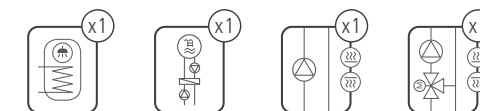

Performance curves

Thermal performance

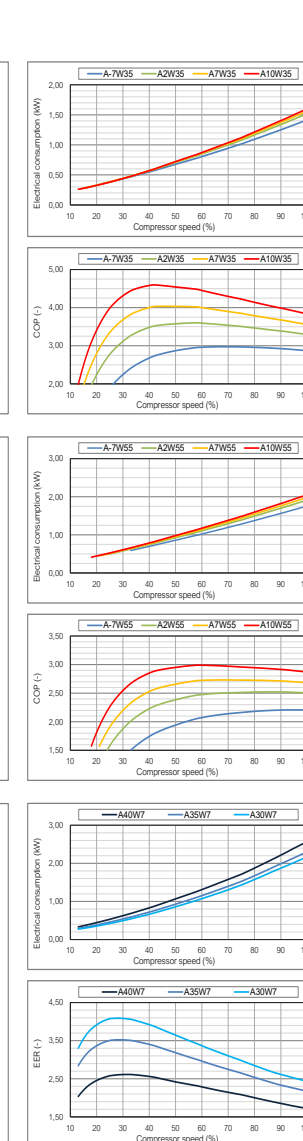
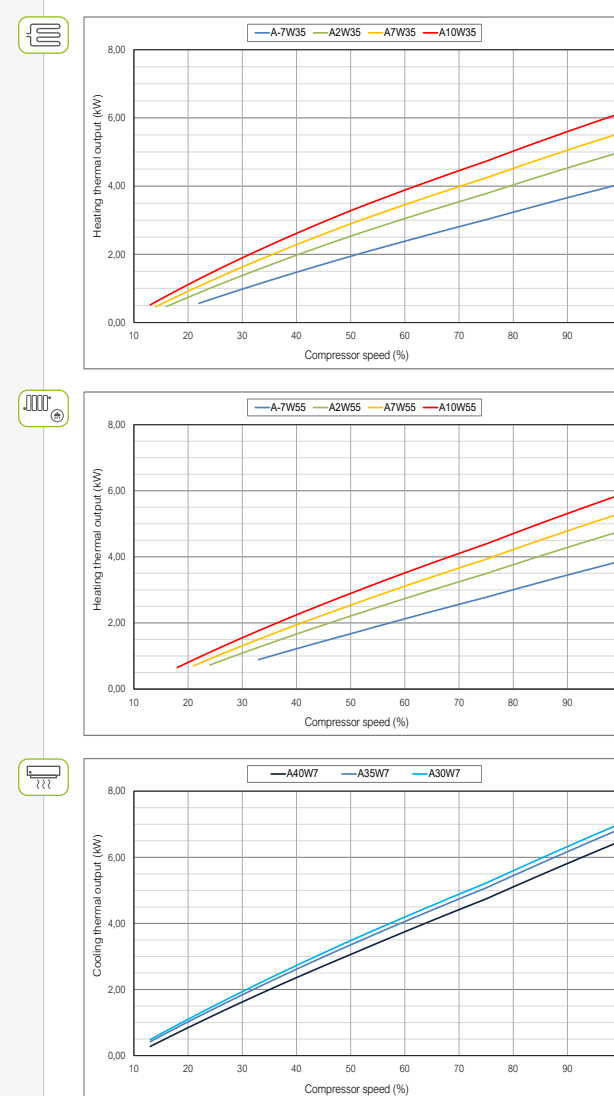

Hydraulic performance

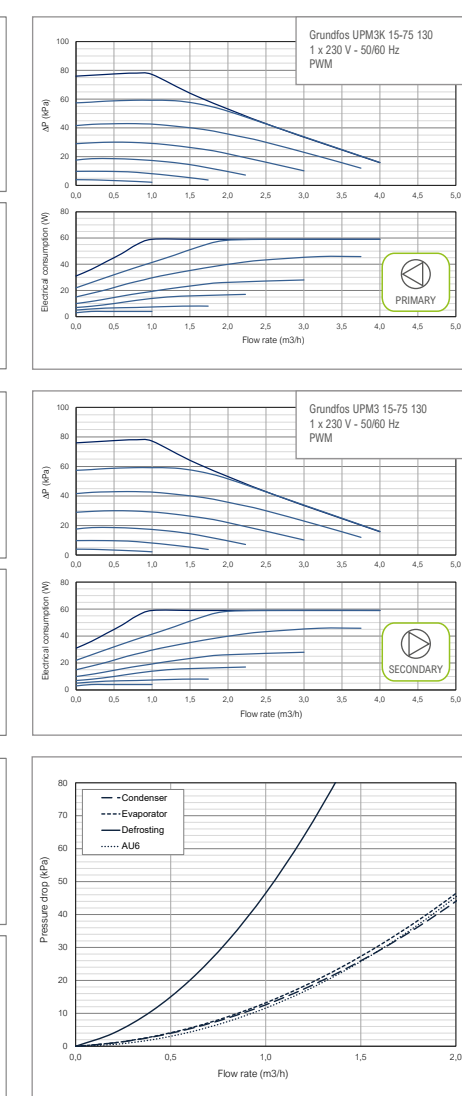

ecoGEO+ B/C 1-9 & AU12

- Modulating thermal power control within a wide range (12,5-100%) and modulating flow rate control of both brine and production circuits (20-100%).
- Inverter technology and scroll compressor.
- Compact design including brine and production circulation pumps, brine and production expansion vessels (8l and 12l respectively), brine and production safety valves and DHW three-way valve.
- High Temperature Recovery system (HTR) for DHW production up to 70 °C without electrical support and simultaneous production of DHW and heating/cooling.
- Integrated management of up to 3 different emission temperatures, 2 buffer tanks (heating and cooling), 1 DHW tank, 1 pool and hourly control of DHW recirculation.
- Integrated management of aerothermal collection modulating units, in case of air source or hybrid configurations.
- Integrated management of external On/Off or modulating auxiliary systems, such as electrical heaters, On/Off boilers or modulating boilers.
- Integrated management of cascade systems up to 3 units.
- Exclusive defrosting system.
- Integrated active cooling in models 4.
- Single-phase and Three-phase versions available.
- Integrated photovoltaic hybridisation.
- Integrated energy meters to measure the electrical consumption, the heating/cooling thermal power, the COP and the monthly and annual SPF.

SPECIFICATIONS ecoGEO+ B/C 1-9 & AU12		UNITS	B2/C2	B4/C4
APPLICATION	Place of installation	-	Indoors: ecoGEO+ 1-9 · Outdoors: AU12	
	Type of brine system ¹	-	Air source / Hybrid source	
	DHW, Heating and Pool	-	✓	✓
	High Temperature Recovery (HTR) system option	-	✓	✓ by default
	Integrated Active cooling	-	-	-
	Integrated ecoGEO+ defrosting system	-	✓	✓
PERFORMANCE	Modulation range of the compressor	%	12,5 to 100	
	Heating power output ² , A7W35	kW	1,7 to 11,0	
	COP ² , A7W35	-	5,0	
	Active cooling power output ² , A35W7	kW	-	1,5 to 9,8
	EER ² , A35W7	-	-	3,6
	Max. DHW temperature without / with support ⁵	°C	63 / 70	
	Noise power emission level ⁶	db	33 to 44	
	Energy label / rjs / SCOP W35 average climate control	-	A+++ / 192% / 4,91	
	Energy label / rjs / SCOP W55 average climate control	-	A++ / 143% / 3,68	
	OPERATION LIMITS	Distribution / Set heating outlet temperature range	°C	10 to 60 / 20 to 60
Distribution / Set cooling outlet temperature range		°C	5 to 35 / 7 to 25	
Brine inlet temperature range in heating applications		°C	-25 to 35	
Brine inlet temperature range in cooling applications		°C	10 to 60	
Minimum / Maximum refrigerant circuit pressure		bar	2 / 45	
Production / Pre-load circuit pressure		bar	0,5 to 3,0 / 1,5	
Brine / Pre-load circuit pressure		bar	0,5 to 3,0 / 0,7	
Volume / Max. DHW storage tank pressure (ecoGEO+ C)		l / bar	165 / 8	
WORKING FLUIDS	R410A Refrigerant load without HTR / with HTR	kg	0,8 / 0,85	1,0
	Compressor oil type / load	kg	POE / 0,74	
CONTROL ELECTRICAL DATA	1/N/PE 230 V / 50-60 Hz ⁸	-	✓	
	Maximum recommended external protection ⁹	-	C16A	
	Transformer primary circuit fuse	A	0,5	
ELECTRICAL DATA: SINGLE-PHASE	Transformer secondary circuit fuse	A	2,5	
	1/N/PE 230 V / 50-60 Hz ⁸	-	✓	
	Maximum recommended external protection ⁹	-	C25A	
	Maximum consumption ² , A7W35	kW / A	2,7 / 11,8	
	Maximum consumption ² , A7W55	kW / A	3,8 / 16,5	
ELECTRICAL DATA: THREE-PHASE	Minimum / Maximum starting current ⁷	A	2,8 / 5,8	
	Correction of cosine Ø	-	0,96 / 1	
	3/N/PE 400 V / 50-60Hz ⁸	-	✓	
	Maximum recommended external protection ⁹	-	C10A	
	Maximum consumption ² , A7W35	kW / A	2,7 / 4,0	
DIMENSIONS/WEIGHT	Maximum consumption ² , A7W55	kW / A	3,8 / 5,5	
	Minimum / Maximum starting current ⁷	A	0,9 / 1,9	
DIMENSIONS/WEIGHT	Correction of cosine Ø	-	0,96 / 1	
	Height x width x depth	mm	ecoGEO+ B: 1058x600x710 · ecoGEO+ C: 1851x600x720 / AU12: 900x1000x600	
	Empty weight (without assembly)	kg	ecoGEO+ B: 192 · ecoGEO+ C: 253 / AU12: 92	

1. Air source/Hybrid source by replacing/combining the ground source circuit by/with one or more ecoGEO+ AU. Consult the ecoGEO+ AU manual for more detailed information.
 2. In compliance with EN 14511, this includes the consumption of the circulation pumps and the compressor driver.
 3. Considering brine and production flow rates in compliance with EN 14511.
 4. Considering a heat slope from 20°C to 50°C in absence of consumption.
 5. Considering support provided by the emergency electrical heater or the HTR system. Maximum DHW temperature with the HTR system can be limited by
 6. the compressor discharge temperature.
 7. In compliance with EN 12102.
 8. Starting current depends on the working conditions of the hydraulic circuits.
 9. The admissible voltage range for proper operation of the heat pump is ±10%.
 10. Maximum consumption can vary significantly according to working conditions, or if the compressor's operation range is restricted. Consult the technical service manual for more detailed information.
 10. Certification in process.

Dimensions and hydraulic connections

Indoor unit - ecoGEO+ B

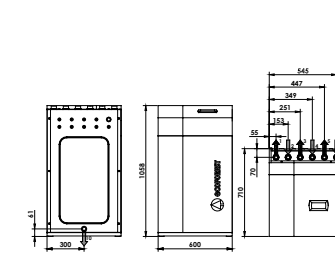

Indoor unit - ecoGEO+ C

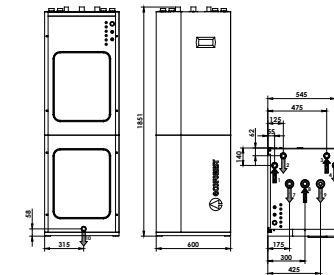

Outdoor unit - AU12

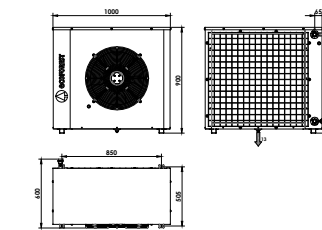

1. Heating/Cooling Outlet - 1 1/4" M
2. Heating/Cooling Inlet - 1 1/4" M
3. Brine Outlet - 1 1/4" M
4. Brine Inlet - 1 1/4" M
5. DHW System Outlet - 1 1/4" M
6. DHW System Inlet - 1 1/4" M
7. CW Inlet - 1" F
8. DHW Outlet - 1" F
9. DHW Recirculation Inlet - 3/4" F
10. Drain - 16 mm
11. AU Source Inlet - 1 1/2" M
12. AU Source Outlet - 1 1/2" M
13. AU Drain - 15 mm

Operational chart

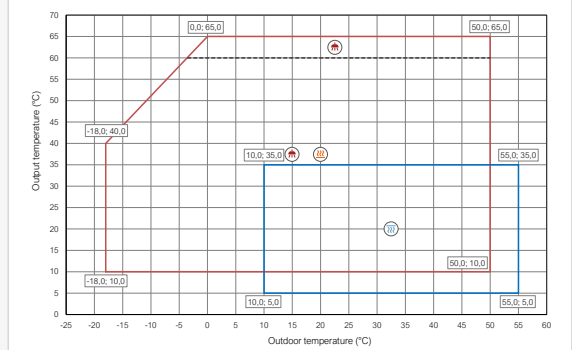

Installation management

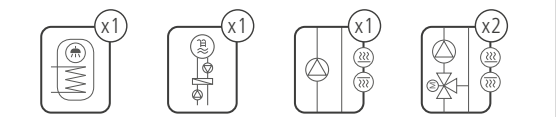

Performance curves

Thermal performance

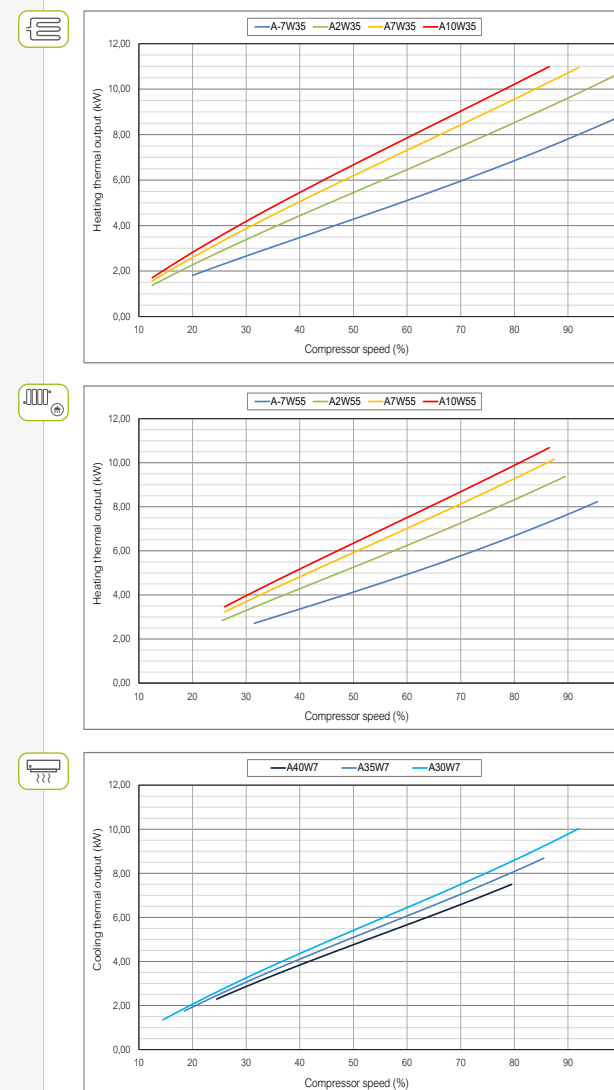

Hydraulic performance

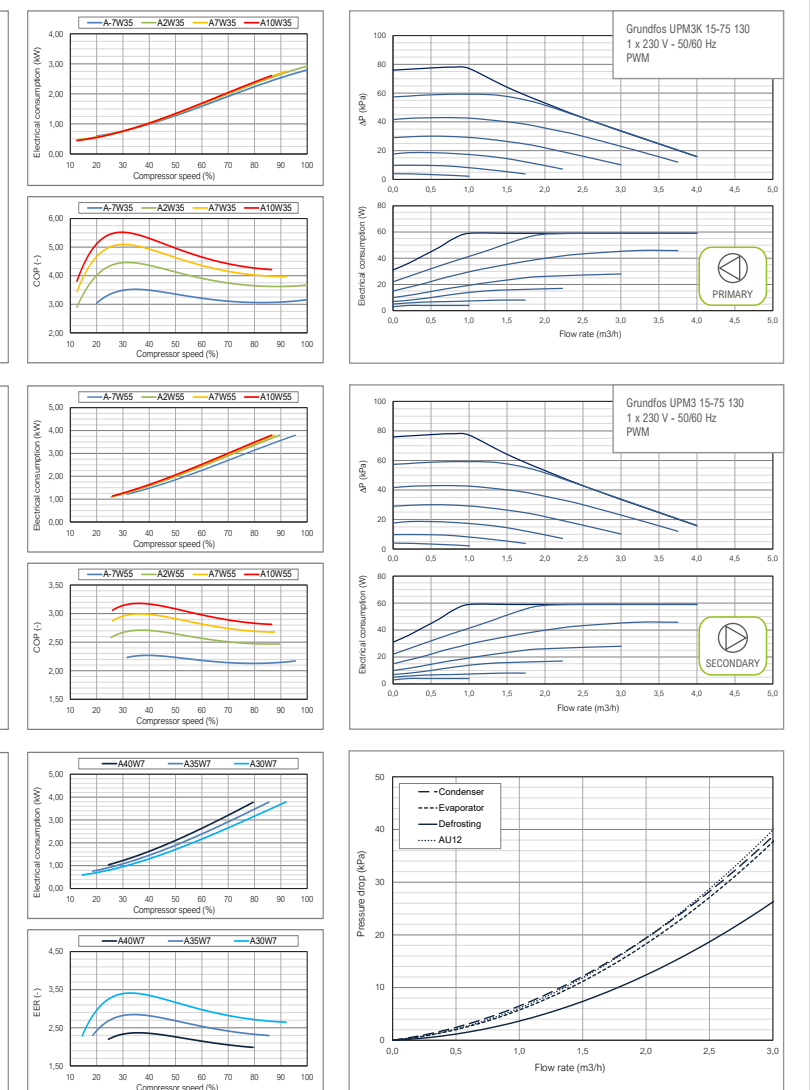

ecoGEO+ B/C 3-12 & AU12

- Modulating thermal power control within a wide range (12,5-100%) and modulating flow rate control of both brine and production circuits (20-100%).
- Inverter technology and scroll compressor.
- Compact design including brine and production circulation pumps, brine and production expansion vessels (8l and 12l respectively), brine and production safety valves and DHW three-way valve.
- High Temperature Recovery system (HTR) for DHW production up to 70 °C without electrical support and simultaneous production of DHW and heating/cooling.
- Integrated management of up to 3 different emission temperatures, 2 buffer tanks (heating and cooling), 1 DHW tank, 1 pool and hourly control of DHW recirculation.
- Integrated management of aerothermal collection modulating units, in case of air source or hybrid configurations.
- Integrated management of external On/Off or modulating auxiliary systems, such as electrical heaters, On/Off boilers or modulating boilers.
- Integrated management of cascade systems up to 3 units.
- Exclusive defrosting system.
- Integrated active cooling in models 4.
- Single-phase and Three-phase versions available.
- Integrated photovoltaic hybridisation.
- Integrated energy meters to measure the electrical consumption, the heating/cooling thermal power, the COP and the monthly and annual SPF.

SPECIFICATIONS ecoGEO+ B/C 3-12 & AU12		UNITS	B2/C2	B4/C4
APPLICATION	Place of installation	-	Indoors: ecoGEO+ 3-12 - Outdoors: AU12	
	Type of brine system ¹	-	Air source / Hybrid source	
	DHW, Heating and Pool	-	✓	✓
	High Temperature Recovery (HTR) system option	-	✓	✓ by default
	Integrated Active cooling	-	-	-
	Integrated ecoGEO+ defrosting system	-	✓	✓
PERFORMANCE	Modulation range of the compressor	%	12,5 to 100	
	Heating power output ² , A7W35	kW	2,5 to 15,3	
	COP ² , A7W35	-	5,0	
	Active cooling power output ² , A35W7	kW	-	2,4 to 11,7
	EER ² , A35W7	-	-	3,4
	Max. DHW temperature without / with support ⁵	°C	63 / 70	
	Noise power emission level ⁶	db	33 to 45	
OPERATION LIMITS	Energy label / rjs / SCOP W35 average climate control	-	A+++ / 193% / 4,92	
	Energy label / rjs / SCOP W55 average climate control	-	A++ / 148% / 3,79	
	Distribution / Set heating outlet temperature range	°C	10 to 60 / 20 to 60	
	Distribution / Set cooling outlet temperature range	°C	5 to 35 / 7 to 25	
	Brine inlet temperature range in heating applications	°C	-25 to 35	
	Brine inlet temperature range in cooling applications	°C	10 to 60	
	Minimum / Maximum refrigerant circuit pressure	bar	2 / 45	
	Production / Pre-load circuit pressure	bar	0,5 to 3,0 / 1,5	
	Brine / Pre-load circuit pressure	bar	0,5 to 3,0 / 0,7	
	Volume / Max. DHW storage tank pressure (ecoGEO+ C)	l / bar	165 / 8	
WORKING FLUIDS	R410A Refrigerant load without HTR / with HTR	kg	0,9 / 1,0	1,0
	Compressor oil type / load	kg	POE / 0,74	
CONTROL ELECTRICAL DATA	1/N/PE 230 V / 50-60 Hz ⁸	-	✓	
	Maximum recommended external protection ⁹	-	C16A	
	Transformer primary circuit fuse	A	0,5	
ELECTRICAL DATA: SINGLE-PHASE	Transformer secondary circuit fuse	A	2,5	
	1/N/PE 230 V / 50-60 Hz ⁸	-	✓	
	Maximum recommended external protection ⁹	-	C32A	
	Maximum consumption ² , A7W35	kW / A	4,2 / 18,6	
	Maximum consumption ² , A7W55	kW / A	5,0 / 21,7	
ELECTRICAL DATA: THREE-PHASE	Minimum / Maximum starting current ⁷	A	2,0 / 8,0	
	Correction of cosine Ø	-	0,96 / 1	
	3/N/PE 400 V / 50-60Hz ⁸	-	✓	
	Maximum recommended external protection ⁹	-	C16A	
	Maximum consumption ² , A7W35	kW / A	4,2 / 6,2	
DIMENSIONS/WEIGHT	Maximum consumption ² , A7W55	kW / A	5,0 / 7,2	
	Minimum / Maximum starting current ⁷	A	0,7 / 2,6	
DIMENSIONS/WEIGHT	Correction of cosine Ø	-	0,96 / 1	
	Height x width x depth	mm	ecoGEO+ B: 1058x600x710 - ecoGEO+ C: 1851x600x720 / AU12: 900x1000x600	
	Empty weight (without assembly)	kg	ecoGEO+ B: 193 - ecoGEO+ C: 254 / AU12: 92	

1. Air source/Hybrid source by replacing/combining the ground source circuit by/with one or more ecoGEO+ AU. Consult the ecoGEO+ AU manual for more detailed information.
 2. In compliance with EN 14511, this includes the consumption of the circulation pumps and the compressor driver.
 3. Considering brine and production flow rates in compliance with EN 14511.
 4. Considering a heat slope from 20°C to 50°C in absence of consumption.
 5. Considering support provided by the emergency electrical heater or the HTR system. Maximum DHW temperature with the HTR system can be limited by
 6. In compliance with EN 12102.
 7. Starting current depends on the working conditions of the hydraulic circuits.
 8. The admissible voltage range for proper operation of the heat pump is ±10%.
 9. Maximum consumption can vary significantly according to working conditions, or if the compressor's operation range is restricted. Consult the technical service manual for more detailed information.
 10. Certification in process.

Dimensions and hydraulic connections

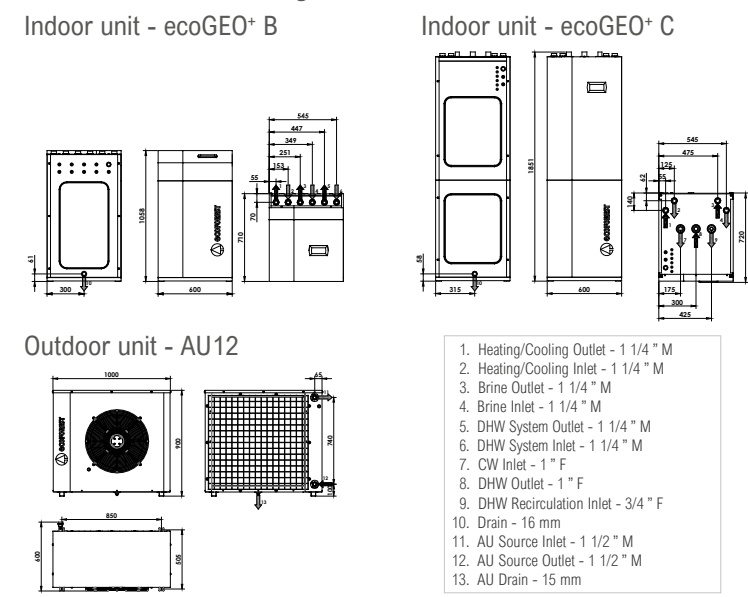

Operational chart

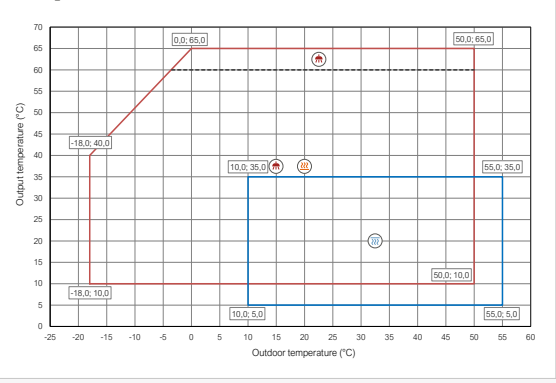

Installation management

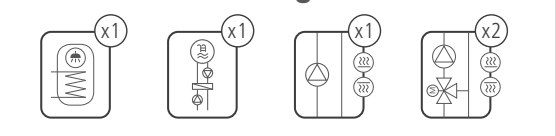

Performance curves

Thermal performance

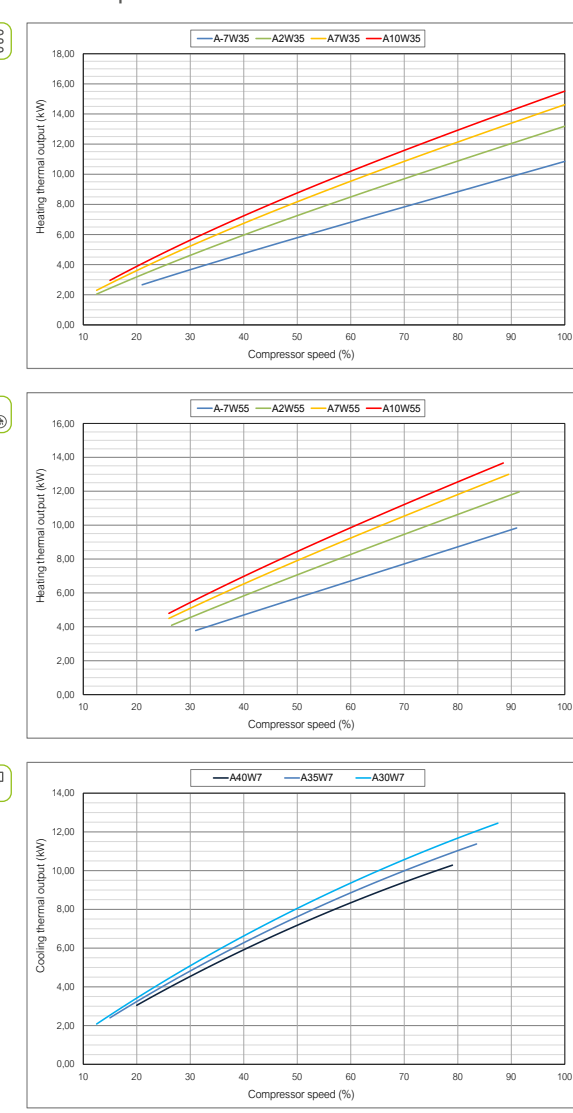

Hydraulic performance

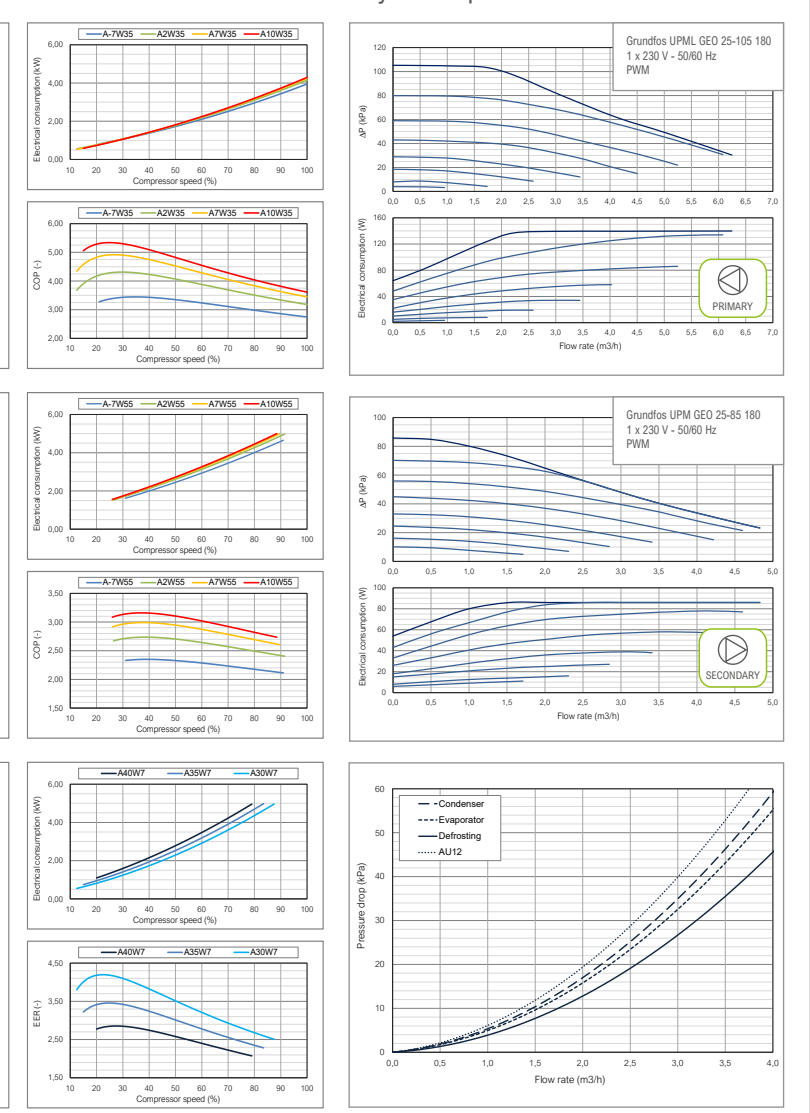

ecoGEO+ B/C 5-22 & AU12

- Modulating thermal power control within a wide range (15-100%) and modulating flow rate control of both brine and production circuits (20-100%).
- Inverter technology and scroll compressor.
- Compact design including brine and production circulation pumps, brine and production expansion vessels (8l and 12l respectively), brine and production safety valves and DHW three-way valve.
- High Temperature Recovery system (HTR) for DHW production up to 70 °C without electrical support and simultaneous production of DHW and heating/cooling.
- Integrated management of up to 3 different emission temperatures, 2 buffer tanks (heating and cooling), 1 DHW tank, 1 pool and hourly control of DHW recirculation.
- Integrated management of aerothermal collection modulating units, in case of air source or hybrid configurations.
- Integrated management of external On/Off or modulating auxiliary systems, such as electrical heaters, On/Off boilers or modulating boilers.
- Integrated management of cascade systems up to 3 units.
- Exclusive defrosting system.
- Integrated active cooling in models 4.
- Single-phase and Three-phase versions available.
- Integrated photovoltaic hybridisation.
- Integrated energy meters to measure the electrical consumption, the heating/cooling thermal power, the COP and the monthly and annual SPF.

SPECIFICATIONS ecoGEO+ B/C 5-22 & AU12		UNITS	B2/C2	B4/C4
APPLICATION	Place of installation	-	Indoors: ecoGEO+ 5-22 · Outdoors: AU12	
	Type of brine system ¹	-	Air source / Hybrid source	
	DHW, Heating and Pool	-	✓	✓
	High Temperature Recovery (HTR) system option	-	✓	✓ by default
	Integrated Active cooling	-	-	-
	Integrated ecoGEO+ defrosting system	-	✓	✓
PERFORMANCE	Modulation range of the compressor	%	15 to 100	
	Heating power output ² , A7W35	kW	4,5 to 19,7	
	COP ² , A7W35	-	4,8	
	Active cooling power output ² , A35W7	kW	-	5,5 to 13,3
	EER ² , A35W7	-	-	3,4
	Max. DHW temperature without / with support ⁵	°C	63 / 70	
	Noise power emission level ⁶	db	35 to 46	
	Energy label / rjs / SCOP W35 average climate control	-	A+++ / 185% / 4,73	
OPERATION LIMITS	Energy label / rjs / SCOP W55 average climate control	-	A++ / 143% / 3,67	
	Distribution / Set heating outlet temperature range	°C	10 to 60 / 20 to 60	
	Distribution / Set cooling outlet temperature range	°C	5 to 35 / 7 to 25	
	Brine inlet temperature range in heating applications	°C	-25 to 35	
	Brine inlet temperature range in cooling applications	°C	10 to 60	
	Minimum / Maximum refrigerant circuit pressure	bar	2 / 45	
	Production / Pre-load circuit pressure	bar	0,5 to 3,0 / 1,5	
	Brine / Pre-load circuit pressure	bar	0,5 to 3,0 / 0,7	
	Volume / Max. DHW storage tank pressure (ecoGEO+ C)	l / bar	165 / 8	
	WORKING FLUIDS	R410A Refrigerant load without HTR / with HTR	kg	1,4
Compressor oil type / load		kg	POE / 1,18	
CONTROL ELECTRICAL DATA	1/N/PE 230 V / 50-60 Hz ⁸	-	✓	
	Maximum recommended external protection ⁹	-	C16A	
	Transformer primary circuit fuse	A	0,5	
ELECTRICAL DATA: SINGLE-PHASE	Transformer secondary circuit fuse	A	2,5	
	1/N/PE 230 V / 50-60 Hz ⁸	-	✓	
	Maximum recommended external protection ⁹	-	C32A	
	Maximum consumption ² , A7W35	kW / A	5,5 / 23,9	
	Maximum consumption ² , A7W55	kW / A	5,5 / 23,9	
ELECTRICAL DATA: THREE-PHASE	Minimum / Maximum starting current ⁷	A	2,6 / 12,5	
	Correction of cosine Ø	-	0,96 / 1	
	3/N/PE 400 V / 50-60Hz ⁸	-	✓	
	Maximum recommended external protection ⁹	-	C13A	
	Maximum consumption ² , A7W35	kW / A	6,0 / 8,7	
DIMENSIONS/WEIGHT	Maximum consumption ² , A7W55	kW / A	6,0 / 8,7	
	Minimum / Maximum starting current ⁷	A	0,9 / 4,2	
	Correction of cosine Ø	-	0,96 / 1	
	Height x width x depth	mm	ecoGEO+ B: 1058x600x710 · ecoGEO+ C: 1851x600x720 / AU12: 900x1000x600	
	Empty weight (without assembly)	kg	ecoGEO+ B: 193 · ecoGEO+ C: 255 / AU12: 92	

1. Air source/Hybrid source by replacing/combining the ground source circuit by/with one or more ecoGEO+ AU. Consult the ecoGEO+ AU manual for more detailed information.
 2. In compliance with EN 14511, this includes the consumption of the circulation pumps and the compressor driver.
 3. Considering brine and production flow rates in compliance with EN 14511.
 4. Considering a heat slope from 20°C to 50°C in absence of consumption.
 5. Considering support provided by the emergency electrical heater or the HTR system. Maximum DHW temperature with the HTR system can be limited by
 6. In compliance with EN 12102.
 7. Starting current depends on the working conditions of the hydraulic circuits.
 8. The admissible voltage range for proper operation of the heat pump is ±10%.
 9. Maximum consumption can vary significantly according to working conditions, or if the compressor's operation range is restricted. Consult the technical service manual for more detailed information.
 10. Certification in process.

Dimensions and hydraulic connections

Indoor unit - ecoGEO+ B

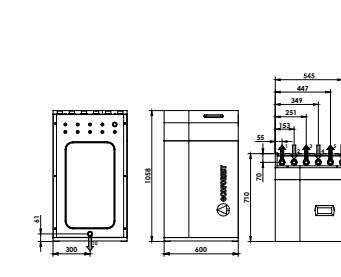

Indoor unit - ecoGEO+ C

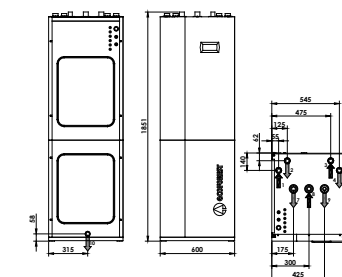

Outdoor unit - AU12

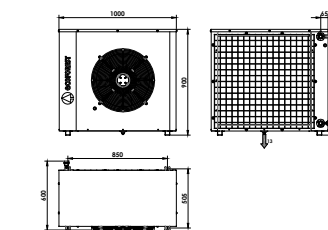

1. Heating/Cooling Outlet - 1 1/4" M
2. Heating/Cooling Inlet - 1 1/4" M
3. Brine Outlet - 1 1/4" M
4. Brine Inlet - 1 1/4" M
5. DHW System Outlet - 1 1/4" M
6. DHW System Inlet - 1 1/4" M
7. CW Inlet - 1" F
8. DHW Outlet - 1" F
9. DHW Recirculation Inlet - 3/4" F
10. Drain - 16 mm
11. AU Source Inlet - 1 1/2" M
12. AU Source Outlet - 1 1/2" M
13. AU Drain - 15 mm

Operational chart

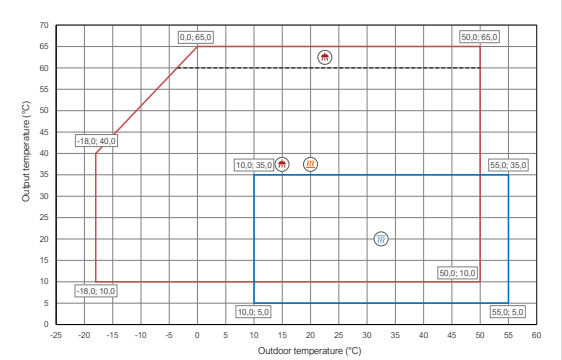

Installation management

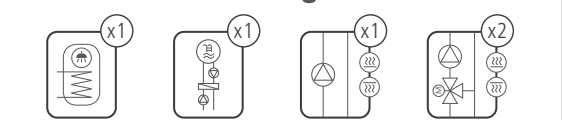

Performance curves

Thermal performance

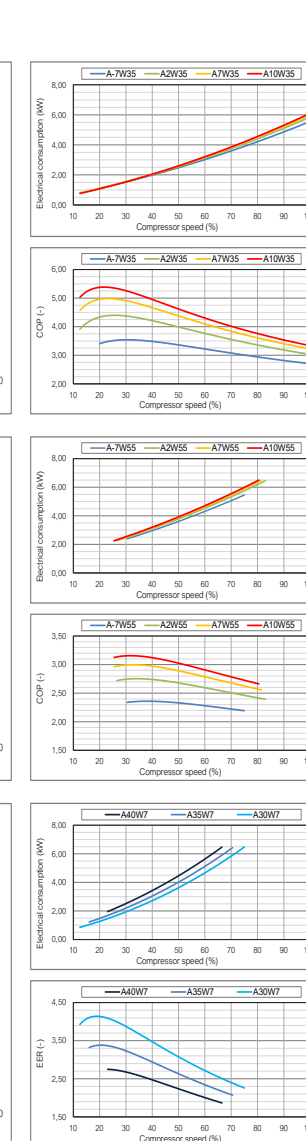
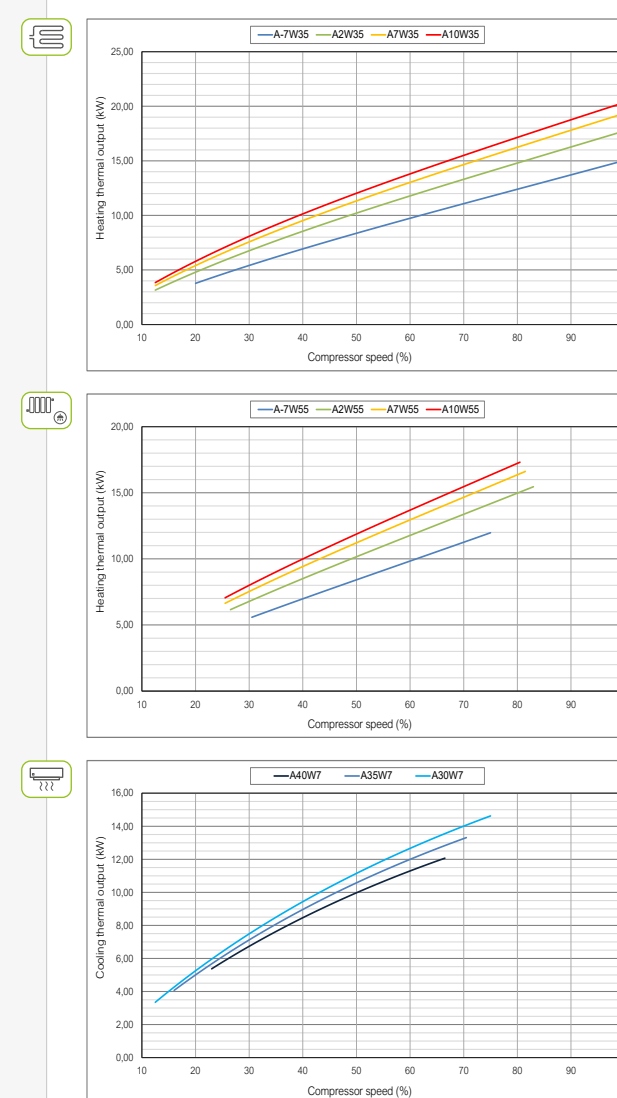

Hydraulic performance

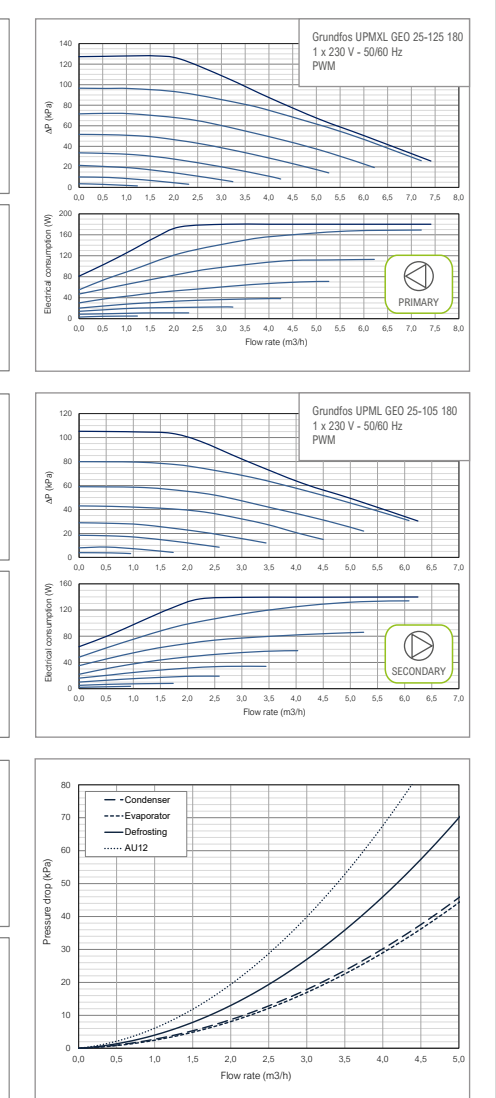

ecoGEO+ B/C 5-22 & AU22

- Modulating thermal power control within a wide range (20-100%) and modulating flow rate control of both brine and production circuits (20-100%).
- Inverter technology and scroll compressor.
- Compact design including brine and production circulation pumps, brine and production expansion vessels (8l and 12l respectively), brine and production safety valves and DHW three-way valve.
- High Temperature Recovery system (HTR) for DHW production up to 70 °C without electrical support and simultaneous production of DHW and heating/cooling.
- Integrated management of up to 3 different emission temperatures, 2 buffer tanks (heating and cooling), 1 DHW tank, 1 pool and hourly control of DHW recirculation.
- Integrated management of aerothermal collection modulating units, in case of air

- source or hybrid configurations.
- Integrated management of external On/Off or modulating auxiliary systems, such as electrical heaters, On/Off boilers or modulating boilers.
- Integrated management of cascade systems up to 3 units.
- Exclusive defrosting system.
- Integrated active cooling in models 4.
- Single-phase and Three-phase versions available.
- Integrated photovoltaic hybridisation.
- Integrated energy meters to measure the electrical consumption, the heating/cooling thermal power, the COP and the monthly and annual SPF.

SPECIFICATIONS ecoGEO+ B/C 5-22 & AU22		UNITS	B2/C2	B4/C4
APPLICATION	Place of installation	-	Indoors: ecoGEO+ 5-22 · Outdoors: AU22	
	Type of brine system ¹	-	Air source / Hybrid source	
	DHW, Heating and Pool	-	✓	✓
	High Temperature Recovery (HTR) system option	-	✓	✓ by default
	Integrated Active cooling	-	-	-
	Integrated ecoGEO+ defrosting system	-	✓	✓
PERFORMANCE	Modulation range of the compressor	%	15 to 100	
	Heating power output ² , A7W35	kW	4,6 to 21,3	
	COP ² , A7W35	-	5,1	
	Active cooling power output ² , A35W7	kW	-	5,1 to 15,2
	EER ² , A35W7	-	-	3,7
	Max. DHW temperature without / with support ⁵	°C	63 / 70	
	Noise power emission level ⁶	db	35 to 46	
	Energy label / rjs / SCOP W35 average climate control	-	A+++ / 194% / 4,95	
Energy label / rjs / SCOP W55 average climate control	-	A++ / 148% / 3,80		
OPERATION LIMITS	Distribution / Set heating outlet temperature range	°C	10 to 60 / 20 to 60	
	Distribution / Set cooling outlet temperature range	°C	5 to 35 / 7 to 25	
	Brine inlet temperature range in heating applications	°C	-25 to 35	
	Brine inlet temperature range in cooling applications	°C	10 to 60	
	Minimum / Maximum refrigerant circuit pressure	bar	2 / 45	
	Production / Pre-load circuit pressure	bar	0,5 to 3,0 / 1,5	
	Brine / Pre-load circuit pressure	bar	0,5 to 3,0 / 0,7	
WORKING FLUIDS	Volume / Max. DHW storage tank pressure (ecoGEO+ C)	l / bar	165 / 8	
	R410A Refrigerant load without HTR / with HTR	kg	1,4	1,5
	Compressor oil type / load	kg	POE / 1,18	
CONTROL ELECTRICAL DATA	1/N/PE 230 V / 50-60 Hz ⁸	-	✓	
	Maximum recommended external protection ⁹	-	C16A	
	Transformer primary circuit fuse	A	0,5	
	Transformer secondary circuit fuse	A	2,5	
ELECTRICAL DATA: SINGLE-PHASE	1/N/PE 230 V / 50-60 Hz ⁸	-	✓	
	Maximum recommended external protection ⁹	-	C32A	
	Maximum consumption ² , A7W35	kW / A	5,5 / 23,9	
	Maximum consumption ² , A7W55	kW / A	5,5 / 23,9	
	Minimum / Maximum starting current ⁷	A	2,6 / 12,5	
ELECTRICAL DATA: THREE-PHASE	3/N/PE 400 V / 50-60Hz ⁸	-	✓	
	Maximum recommended external protection ⁹	-	C13A	
	Maximum consumption ² , A7W35	kW / A	6,0 / 8,7	
	Maximum consumption ² , A7W55	kW / A	6,0 / 8,7	
	Minimum / Maximum starting current ⁷	A	0,9 / 4,2	
DIMENSIONS/WEIGHT	Height x width x depth	mm	ecoGEO+ B: 1058x600x710 · ecoGEO+ C: 1851x600x720 / AU22: 903x1800x600	
	Empty weight (without assembly)	kg	ecoGEO+ B: 193 · ecoGEO+ C: 255 / AU22: 175	

1. Air source/Hybrid source by replacing/combining the ground source circuit by/with one or more ecoGEO+ AU. Consult the ecoGEO+ AU manual for more detailed information.
 2. In compliance with EN 14511, this includes the consumption of the circulation pumps and the compressor driver.
 3. Considering brine and production flow rates in compliance with EN 14511.
 4. Considering a heat slope from 20°C to 50°C in absence of consumption.
 5. Considering support provided by the emergency electrical heater or the HTR system. Maximum DHW temperature with the HTR system can be limited by
 6. In compliance with EN 12102.
 7. Starting current depends on the working conditions of the hydraulic circuits.
 8. The admissible voltage range for proper operation of the heat pump is ±10%.
 9. Maximum consumption can vary significantly according to working conditions, or if the compressor's operation range is restricted. Consult the technical service manual for more detailed information.
 10. Certification in process.

Dimensions and hydraulic connections

Indoor unit - ecoGEO+ B Indoor unit - ecoGEO+ C

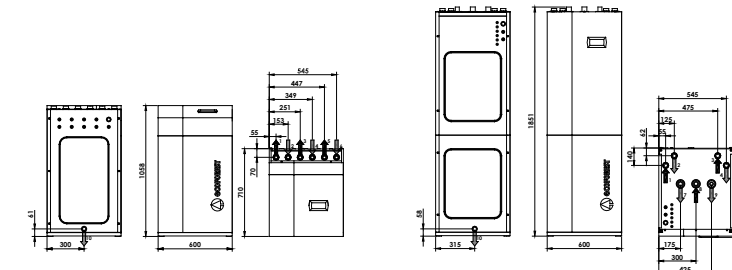

Outdoor unit - AU22

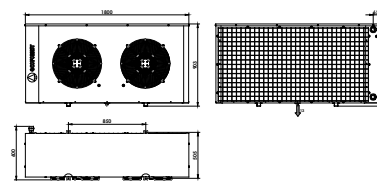

1. Heating/Cooling Outlet - 1 1/4" M
2. Heating/Cooling Inlet - 1 1/4" M
3. Brine Outlet - 1 1/4" M
4. Brine Inlet - 1 1/4" M
5. DHW System Outlet - 1 1/4" M
6. DHW System Inlet - 1 1/4" M
7. CW Inlet - 1" F
8. DHW Outlet - 1" F
9. DHW Recirculation Inlet - 3/4" F
10. Drain - 16 mm
11. AU Source Inlet - 1 1/2" M
12. AU Source Outlet - 1 1/2" M
13. AU Drain - 15 mm

Operational chart

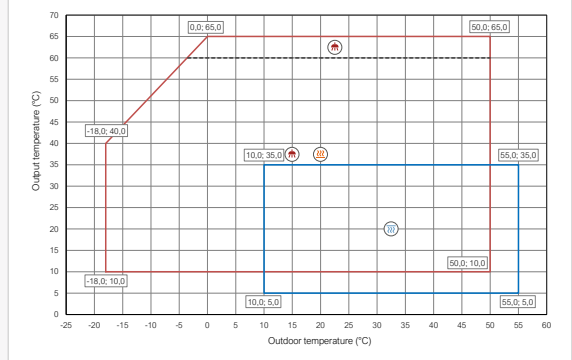

Installation management

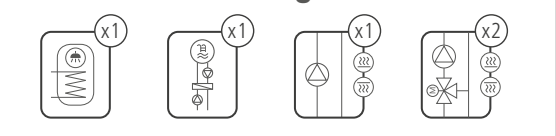

Performance curves

Thermal performance

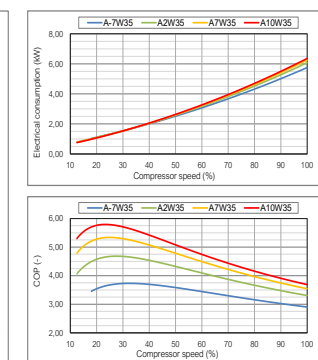
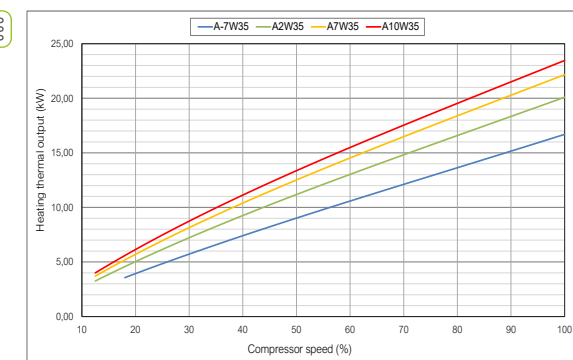

Hydraulic performance

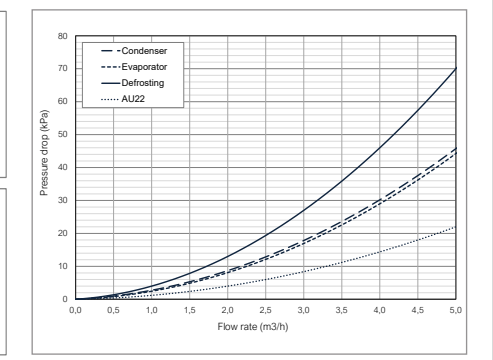
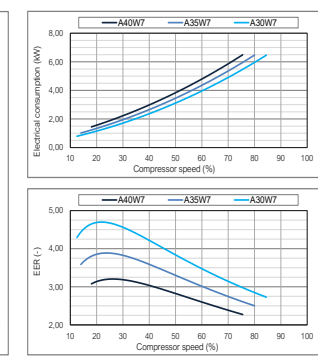
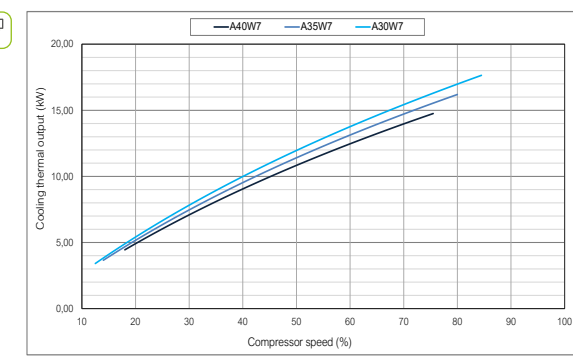
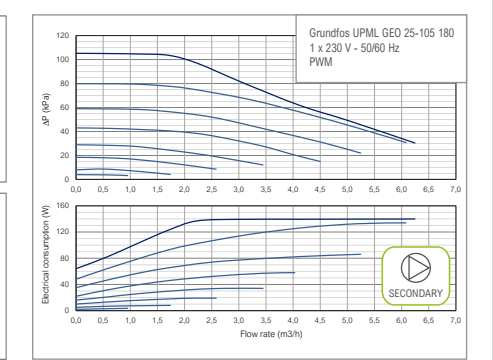
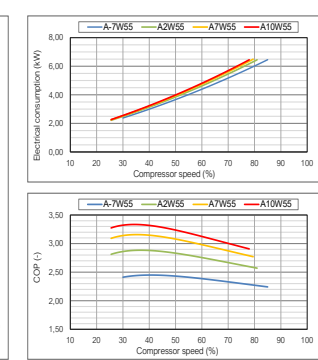
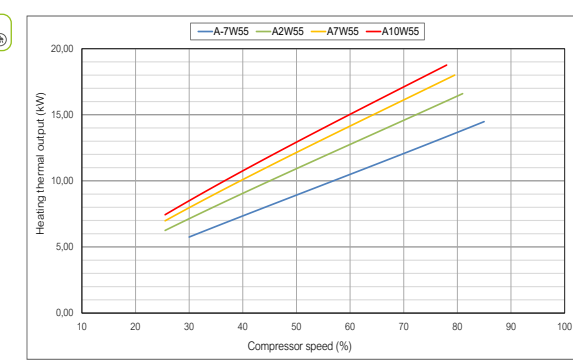
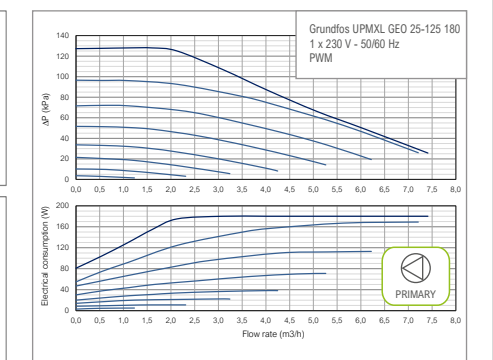

ecoAIR⁺

Monobloc air source heat pumps



ecoAIR⁺

Monobloc Inverter air source

The ecoAIR⁺ range is the Ecoforest range of air-to-water heat pumps. These heat pumps use Inverter technology and are also capable of offering all the services required in a HVAC system in an integrated way: DHW, Heating, Pool and Cooling.



All ecoAIR⁺ heat pumps make use of Inverter technology, which allows them to modulate their power in order to adapt to the thermal demands of the installation with the highest efficiency. This translates into a very considerable reduction in electrical consumption and great savings. The ecoAIR⁺ EVI heat pumps make a unique use of EVI technology to guarantee unique performances in any operating condition, and the ecoAIR⁺ PRO heat pumps use a natural refrigerant, being the only propane monobloc aérothermal heat pumps that have modulation ranges greater than 80%. Thanks to the technology and control strategies developed by Ecoforest, the installation of ecoAIR⁺ heat pumps in combination with the HK and HK-Compact indoor units also becomes simpler, more compact and cheaper than those of other heat pumps on the market, since it allows to dispense with certain components that would be necessary in traditional heat pump installations.



ecoAIR+ PRO

Residential range



Power ranges

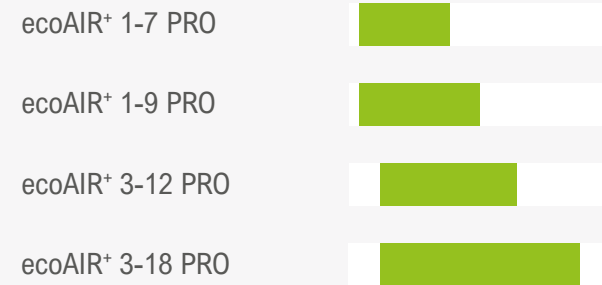

Monobloc heat pump



Services



DHW



Heating



Cooling



Pool

Indoor units

CM	HK-EH	HK-EH-S	HK-Compact-EH	HK-Compact-EH-S
Controller	Controller	Controller	Controller	Controller
Display	Display	Display	Display	Display
	Filling kit & filter	Filling kit & filter	Filling kit & filter	Filling kit & filter
	DHW 3-way valve	DHW 3-way valve	DHW 3-way valve	DHW 3-way valve
	Support electrical heater	Support electrical heater	Support electrical heater	Support electrical heater
		Heat exchanger & circulation pump	165l stainless steel DHW tank	Heat exchanger & circulation pump
				165l stainless steel DHW tank
				Expansion vessel & safety valve

Unique performances

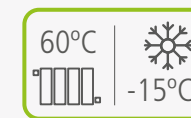

DHW production and Heating

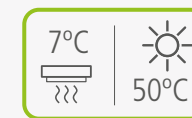

Cooling

Inverter technology

Power ranges: 1-7 kW / 1-9 kW / 3-12 kW / 3-18 kW

Natural refrigerant: R290

Hot water production temperatures up to 75°C

Domestic hot water production

Heating and pool production

Integrated active cooling production

Modulating speed fan

Internet connection through the ecoSMART Easynet

Integrated photovoltaic hybridisation

Single-phase (230V) or three-phase (400V) power supply

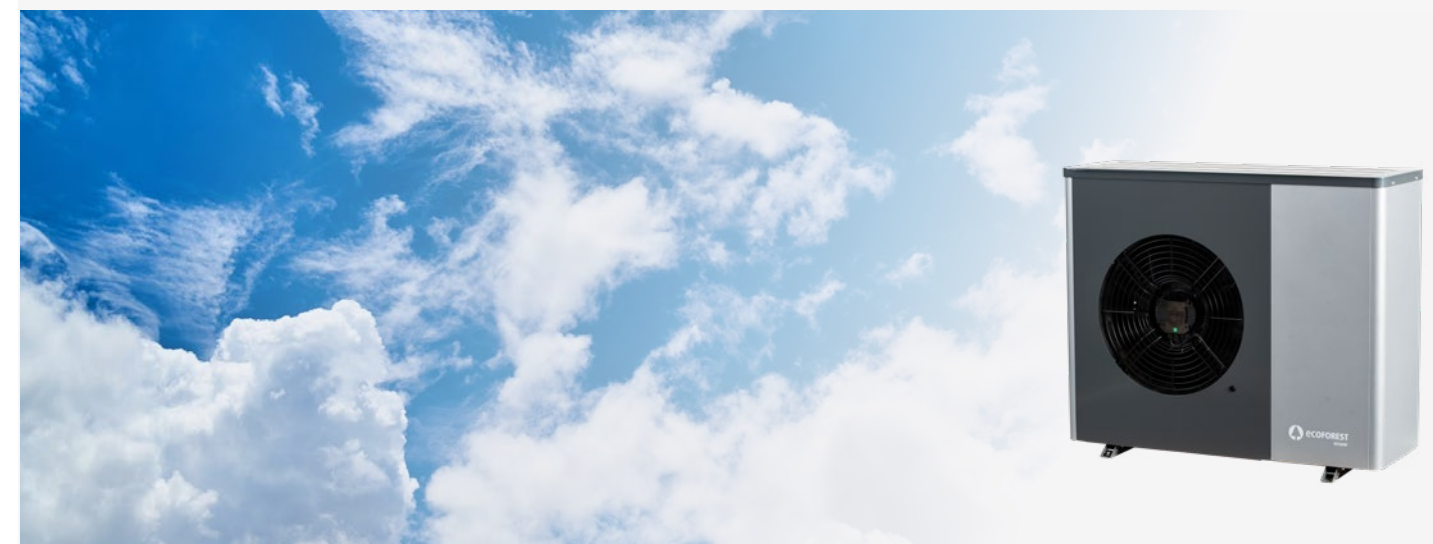

Indoor units

CM / HK / HK-Compact

- Indoor hydraulic units to be used in combination with ecoAIR+ PRO monobloc aérothermal heat pumps.
- CM, HK & HK-Compact: including the electrical box that allows to control the heat pump.
- HK & HK-Compact: including the main hydraulic components of the installation in several combinations.
- HK-Compact: integrating a 165l stainless steel DHW tank.
- Plug&play compact units that make the hydraulic system simpler and the installation easier.
- Single-phase control electrical box.
- Single-phase or Three-phase optional support electrical heater.

SPECIFICATIONS ecoAIR+ PRO INDOOR UNITS		UNITS	CM	HK		HK-Compact	
				HK-EH	HK-EH-S	HK-Compact-EH	HK-Compact-EH-S
APPLICATION	Place of installation	-	-	Indoors			
	DHW	-	✓	✓	✓	✓	✓
	Heating and Pool	-	✓	✓	✓	✓	✓
	Cooling	-	✓	✓	✓	✓	✓
INTEGRATED HYDRAULIC COMPONENTS	Filling kit and filter	-	-	✓	✓	✓	✓
	DHW three-way valve	-	-	✓	✓	✓	✓
	Support electrical heater	-	-	✓	✓	✓	✓
	Separation plate heat exchanger	-	-	-	✓	-	✓
	Secondary circuit circulation pump	-	-	-	✓	-	✓
	Stainless steel DHW tank	-	-	-	-	✓	✓
	Primary / Secondary expansion vessel	-	-	-	-	✓(12l)	✓(8l) / ✓(12l)
OPERATION LIMITS	Production circuit pressure	bar	-	0,5 - 3,0			
	DHW tank volume	l	-	165			
	DHW tank maximum pressure	bar	-	8,0			
	DHW tank maximum temperature	°C	-	80			
CONTROL ELECTRICAL DATA	1/N/PE 230 V / 50-60 Hz ¹	-	-	✓			
	Recommended external protection	-	-	C16A			
	Transformer primary circuit fuse	A	-	0,5			
ELECTRICAL DATA: INTEGRATED SUPPORT ELECTRICAL HEATER	Transformer secondary circuit fuse	A	-	2,5			
	Supply: 1/N/PE 230Vac / 50-60 Hz ¹	-	-	✓			
	Number of elements	-	-	1 ² / 1-2-3			
	Recommended external protection 1-2-3	-	-	C16A ² / C10A-C16A-C20A			
	Maximum power consumption 1-2-3	kW	-	2,0 ² / 1,3-2,7-4,0			
	Maximum current consumption 1-2-3	A	-	10,0 ² / 6,3-12,6-18,9			
	Supply: 3/N/PE 400Vac / 50-60 Hz ¹	-	-	✓			
	Recommended external protection	-	-	C10A			
	Maximum power consumption	kW	-	4,0			
	Maximum current consumption	A	-	6,3			
DIMENSIONS/WEIGHT	Correction of cosine Ø	-	-	0,96 / 1			
	Height x width x depth	mm	600x400x158	713x525x304		1773x600x679	
	Empty weight (without assembly)	kg	15	41 ² / 40		130	

1. The admissible voltage range for proper operation of the heat pump is ±10%.
2. Data to be considered in case of HK-EH or HK-Compact-EH for ecoAIR+ 1-7kW PRO models.

Dimensions and hydraulic connections

Indoor Units

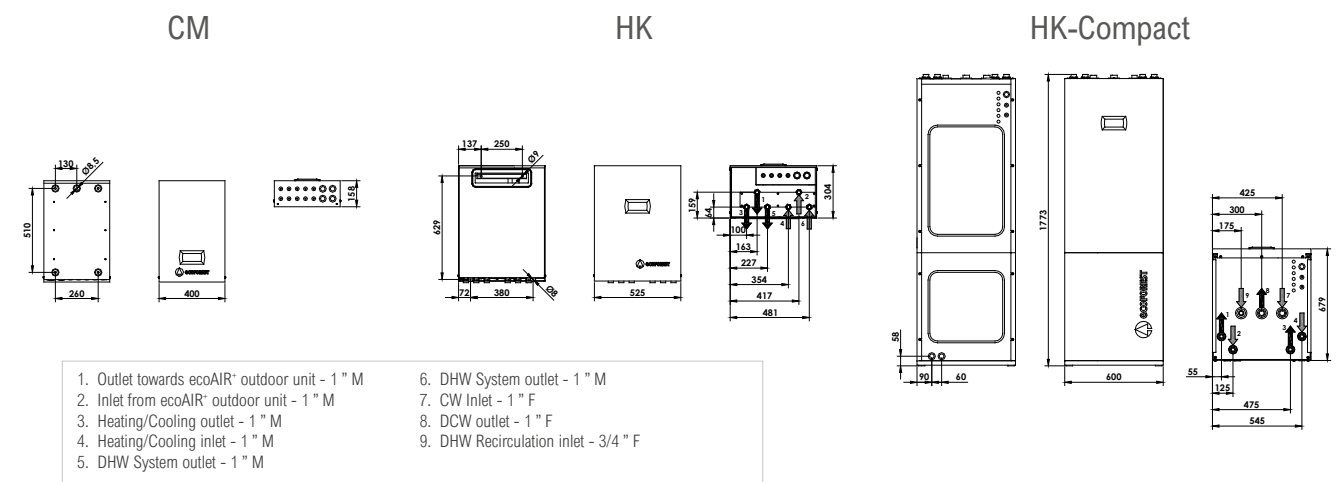

Hydraulic characteristics

Hydraulic layouts

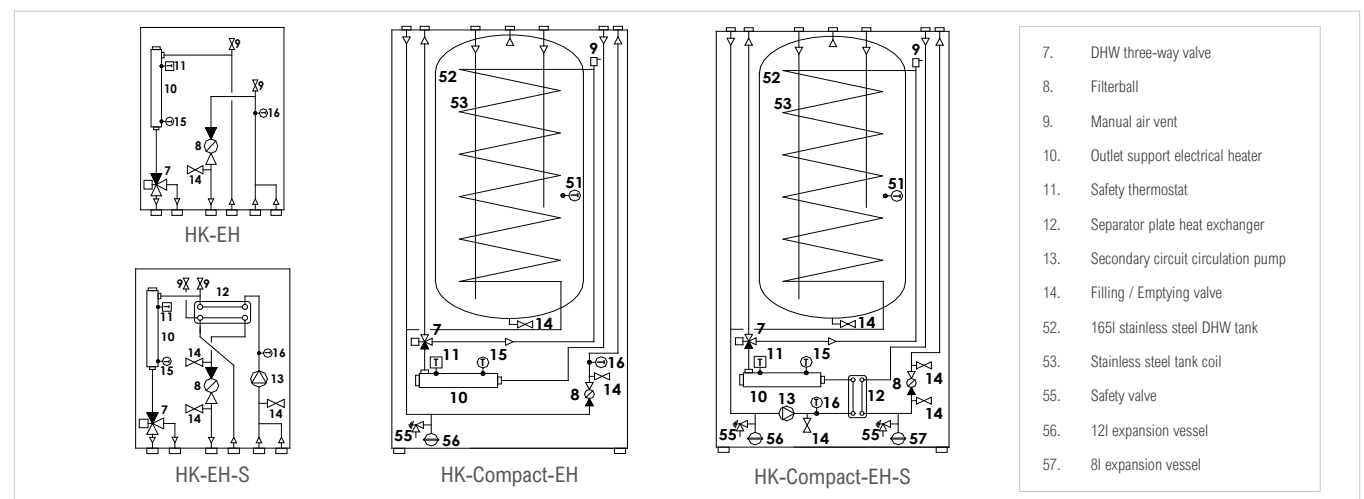

Models including hydraulic separation : HK-EH-S / HK-Compact-EH-S

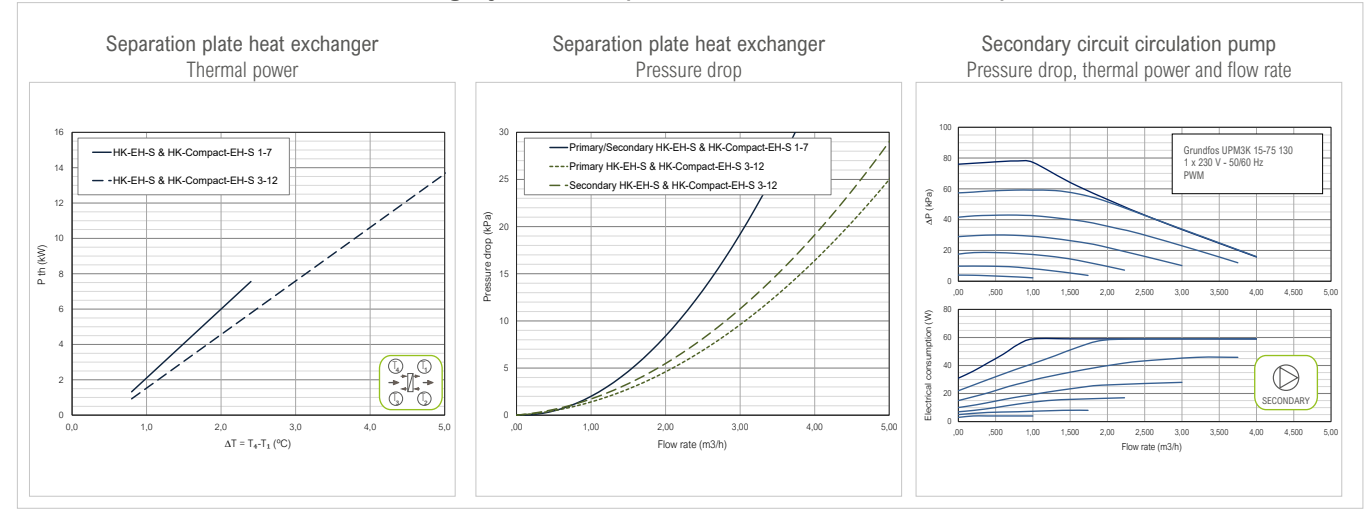

ecoAIR+ 1-7 PRO



- Modulating thermal power control within a wide range (12,5-100%) and modulating flow rate control of the production circuit (20-100%).
- Natural refrigerant R290 : GWP 3.
- Inverter technology and scroll compressor.
- Compact design including the production circulation pump in the outdoor unit. Hydraulic connection within the outdoor unit and the indoor unit.
- Integrated management of up to 3 different emission temperatures, 2 buffer tanks (heating and cooling), 1 DHW tank, 1 pool and hourly control of DHW recirculation.
- Integrated management of simultaneous heating/cooling emission, according to scheme.
- Integrated management of external On/Off or modulating auxiliary systems, such as electrical heaters, On/Off boilers or modulating boilers.
- Integrated active cooling.
- Selection of the indoor unit depending on the installation needs.
- Single-phase version available.
- Integrated photovoltaic hybridisation.
- Integrated energy meters to measure the electrical consumption, the heating/cooling thermal power, the COP and the monthly and annual SPF.

SPECIFICATIONS ecoAIR+ 1-7 PRO		UNITS	
APPLICATION	Place of installation	-	Outdoors
	Type of brine system ¹	-	Air source
	DHW, Heating and Pool	-	✓
	Integrated Active cooling	-	✓
PERFORMANCE	Modulation range of the compressor	%	12,5 to 100
	Heating power output ² , A7W35	kW	1,0 to 7,0
	COP ² , A7W35	-	5,2
	Heating power output ² , A7W55	kW	1,0 to 6,5
	COP ² , A7W55	-	3,3
	Active cooling power output ² , A35W7	kW	1,0 to 5,6
	EER ² , A35W7	-	5,5
	Max. DHW temperature without / with support ⁵	°C	75 / 80
	Noise power emission level ⁶	db	58
	Energy label / rjs / SCOP W35 average climate control	-	A+++ / 179% / 4,45
Energy label / rjs / SCOP W55 average climate control	-	A++ / 139% / 3,45	
OPERATION LIMITS	Distribution / Set heating outlet temperature range	°C	10 to 75 / 20 to 75
	Distribution / Set cooling outlet temperature range	°C	5 to 30 / 7 to 30
	Outdoor temperature range	°C	-22 to 50
	Minimum / Maximum refrigerant circuit pressure	bar	0,5 / 31,5
WORKING FLUIDS	Production circuit pressure	bar	0,5 to 3,0
	R290 Refrigerant load	kg	0,75
	Compressor oil type / load	kg	PZ46M / 0,3
CONTROL ELECTRICAL DATA	Air flow (60% fan)	m ³ /h	2385
	1/N/PE 230 V / 50-60 Hz ⁸	-	✓
	Maximum recommended external protection ⁹	-	C5A
	Transformer primary circuit fuse	A	0,5
ELECTRICAL DATA: SINGLE-PHASE	Transformer secondary circuit fuse	A	2,5
	1/N/PE 230 V / 50-60 Hz ⁸	-	✓
	Maximum recommended external protection ⁹	-	C16A
	Maximum consumption ² , A7W35	kW / A	1,5 / 7,6
	Maximum consumption ² , A7W55	kW / A	2,0 / 9,8
DIMENSIONS/WEIGHT	Minimum / Maximum starting current ⁷	A	1,1 / 1,3
	Correction of cosine Ø	-	0,96 / 1
	Height x width x depth	mm	823x1050x435
	Empty weight (without assembly)	kg	115

1. Outdoor air-to-water monobloc unit.
 2. In compliance with EN 14511, this includes the consumption of the circulation pumps and the compressor driver.
 3. Considering production flow rate in compliance with EN 14511.
 4. Considering a heat slope from 20°C to 50°C in absence of consumption.
 5. Considering support provided by the emergency electrical heater.
 6. In compliance with EN 12102.
 7. Starting current depends on the working conditions of the hydraulic circuits.
 8. The admissible voltage range for proper operation of the heat pump is ±10%.
 9. Maximum consumption can vary significantly according to working conditions, or if the compressor's operation range is restricted. Consult the technical service manual for more detailed information.
 10. Certification in process.

Dimensions and hydraulic connections

Indoor units

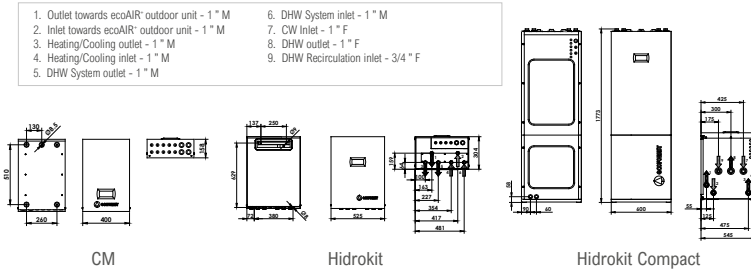

Outdoor unit - ecoAIR+

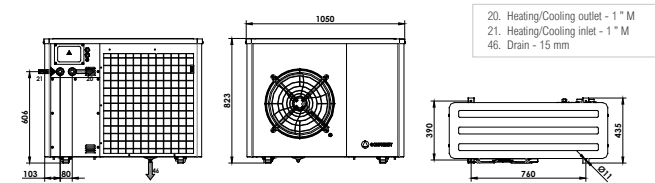

Operational chart

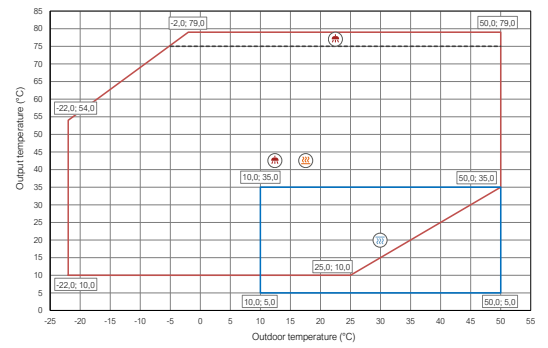

Installation management

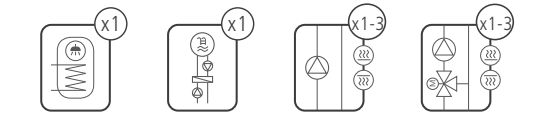

Performance curves

Thermal performance

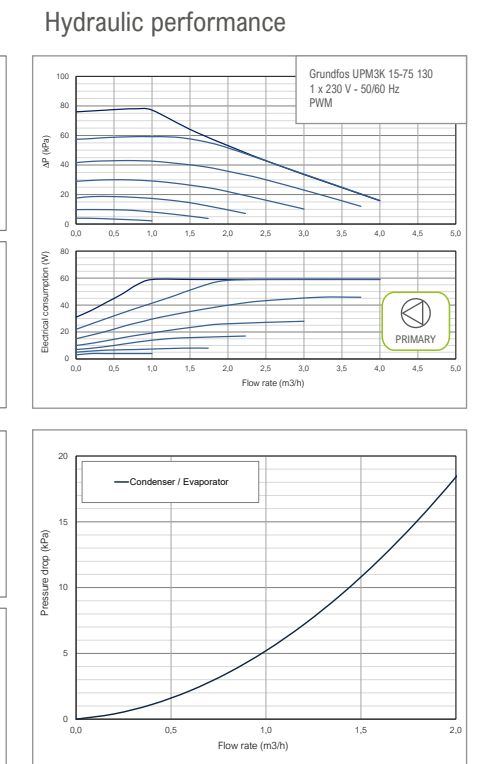
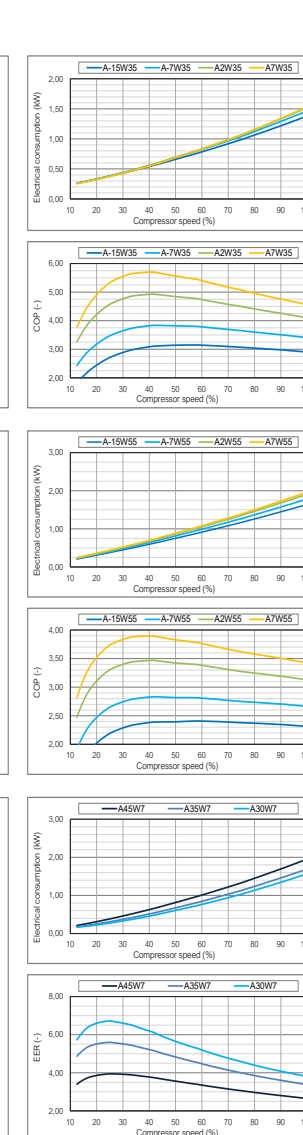
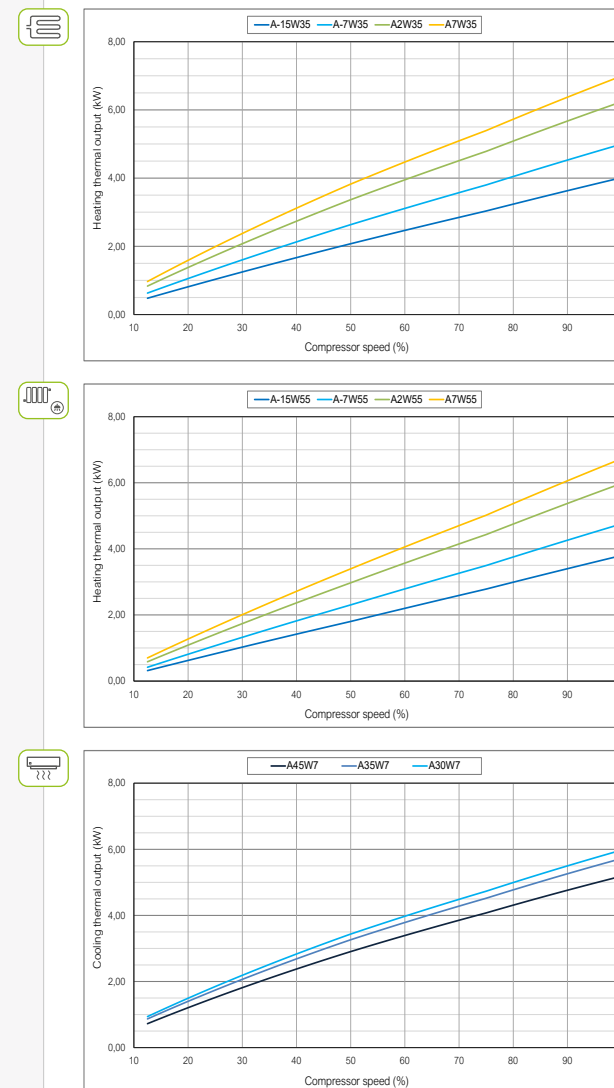

ecoAIR+ 1-9 PRO



- Modulating thermal power control within a wide range (17-100%) and modulating flow rate control of the production circuit (20-100%).
- Natural refrigerant R290 : GWP 3.
- Inverter technology and scroll compressor.
- Compact design including the production circulation pump in the outdoor unit. Hydraulic connection within the outdoor unit and the indoor unit.
- Integrated management of up to 3 different emission temperatures, 2 buffer tanks (heating and cooling), 1 DHW tank, 1 pool and hourly control of DHW recirculation.
- Integrated management of simultaneous heating/cooling emission, according to scheme.
- Integrated management of external On/Off or modulating auxiliary systems, such as electrical heaters, On/Off boilers or modulating boilers.
- Integrated active cooling.
- Selection of the indoor unit depending on the installation needs.
- Single-phase version available.
- Integrated photovoltaic hybridisation.
- Integrated energy meters to measure the electrical consumption, the heating/cooling thermal power, the COP and the monthly and annual SPF.

SPECIFICATIONS ecoAIR+ 1-9 PRO		UNITS	
APPLICATION	Place of installation	-	Outdoors
	Type of brine system ¹	-	Air source
	DHW, Heating and Pool	-	✓
	Integrated Active cooling	-	✓
PERFORMANCE	Modulation range of the compressor	%	17 to 100
	Heating power output ² , A7W35	kW	1,7 to 8,7
	COP ² , A7W35	-	5,0
	Heating power output ² , A7W55	kW	2,1 to 8,0
	COP ² , A7W55	-	3,2
	Active cooling power output ² , A35W7	kW	1,1 to 7,1
	EER ² , A35W7	-	4,0
	Max. DHW temperature without / with support ⁵	°C	70 / 80
	Noise power emission level ⁶	db	57
	Energy label / rjs / SCOP W35 average climate control	-	A+++ / 184% / 4,57
Energy label / rjs / SCOP W55 average climate control	-	A++ / 146% / 3,63	
OPERATION LIMITS	Distribution / Set heating outlet temperature range	°C	10 to 70 / 20 to 70
	Distribution / Set cooling outlet temperature range	°C	5 to 30 / 7 to 30
	Outdoor temperature range	°C	-22 to 50
	Minimum / Maximum refrigerant circuit pressure	bar	0,5 / 27,5
WORKING FLUIDS	Production circuit pressure	bar	0,5 to 3,0
	R290 Refrigerant load	kg	0,85
	Compressor oil type / load	kg	HXL4467 / 0,74
CONTROL ELECTRICAL DATA	Air flow (60% fan)	m ³ /h	3510
	1/N/PE 230 V / 50-60 Hz ⁸	-	✓
	Maximum recommended external protection ⁹	-	C5A
	Transformer primary circuit fuse	A	0,5
ELECTRICAL DATA: SINGLE-PHASE	Transformer secondary circuit fuse	A	2,5
	1/N/PE 230 V / 50-60 Hz ⁸	-	✓
	Maximum recommended external protection ⁹	-	C16A
	Maximum consumption ² , A7W35	kW / A	1,9 / 9,5
	Maximum consumption ² , A7W55	kW / A	2,6 / 13,0
DIMENSIONS/WEIGHT	Minimum / Maximum starting current ⁷	A	3,3 / 4,4
	Correction of cosine Ø	-	0,97 / 1
	Height x width x depth	mm	973x1150x475
	Empty weight (without assembly)	kg	134

1. Outdoor air-to-water monobloc unit.
 2. In compliance with EN 14511, this includes the consumption of the circulation pumps and the compressor driver.
 3. Considering production flow rate in compliance with EN 14511.
 4. Considering a heat slope from 20°C to 50°C in absence of consumption.
 5. Considering support provided by the emergency electrical heater.
 6. In compliance with EN 12102.
 7. Starting current depends on the working conditions of the hydraulic circuits.
 8. The admissible voltage range for proper operation of the heat pump is ±10%.
 9. Maximum consumption can vary significantly according to working conditions, or if the compressor's operation range is restricted. Consult the technical service manual for more detailed information.
 10. Certification in process.

Dimensions and hydraulic connections

Indoor units

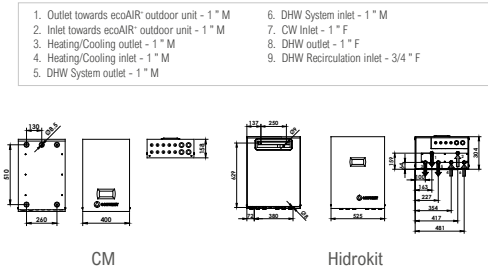

Outdoor unit - ecoAIR+

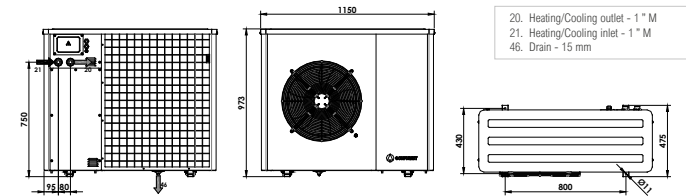

Operational chart

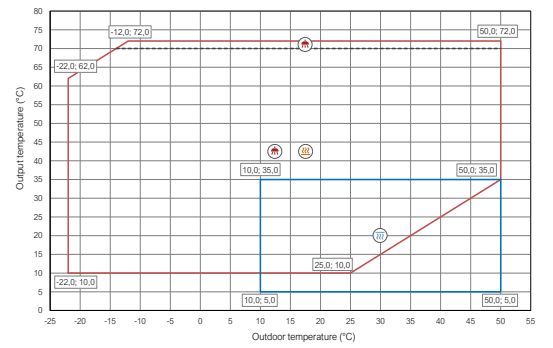

Installation management

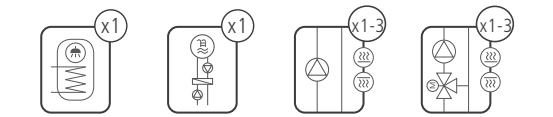

Performance curves

Thermal performance

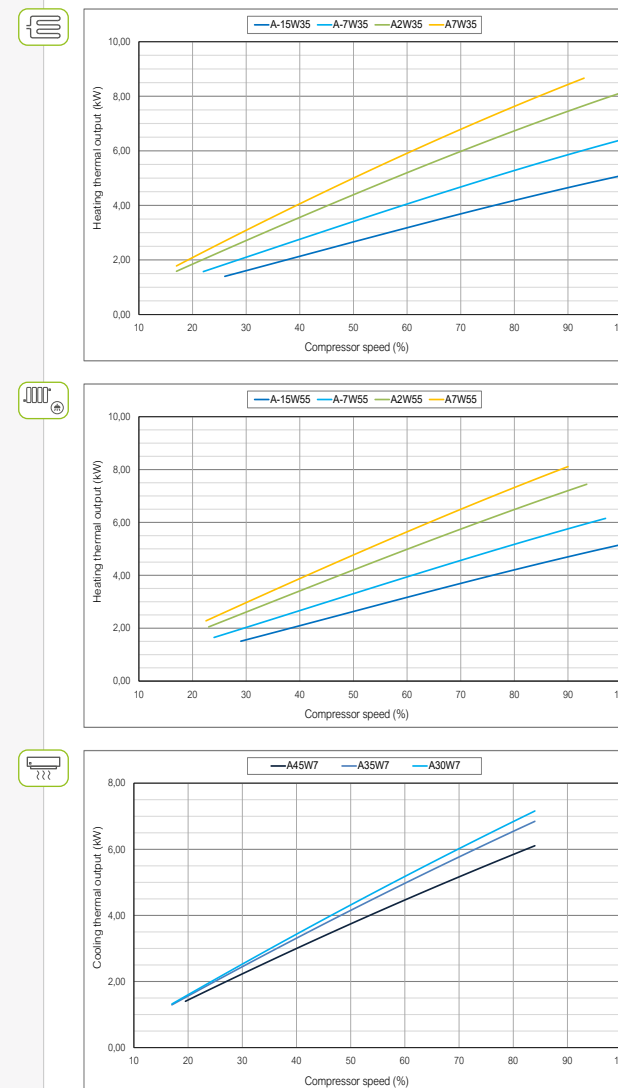

Hydraulic performance

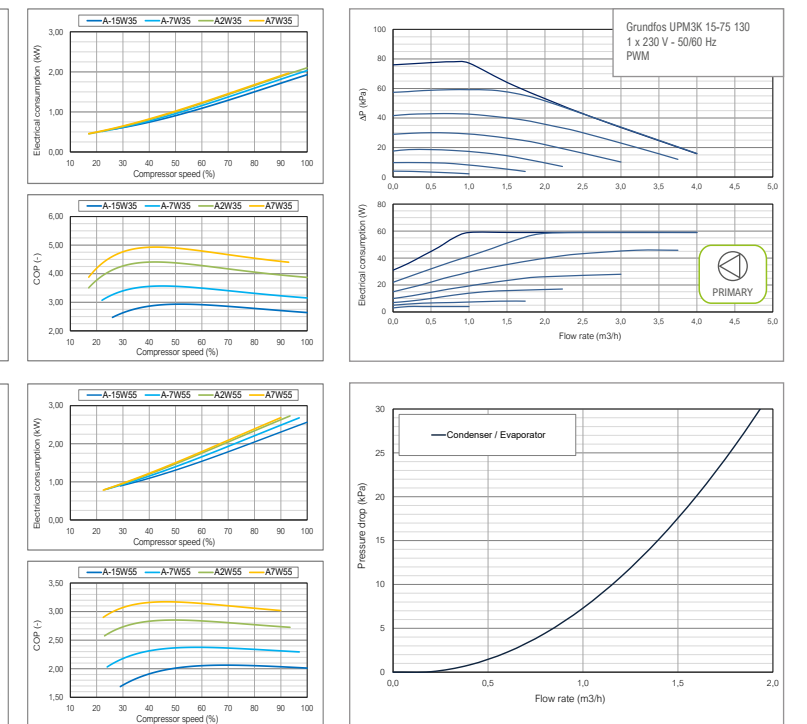

ecoAIR+ 3-12 PRO



- Modulating thermal power control within a wide range (17-100%) and modulating flow rate control of the production circuit (20-100%).
- Natural refrigerant R290 : GWP 3.
- Inverter technology and scroll compressor.
- Compact design including the production circulation pump in the outdoor unit. Hydraulic connection within the outdoor unit and the indoor unit.
- Integrated management of up to 3 different emission temperatures, 2 buffer tanks (heating and cooling), 1 DHW tank, 1 pool and hourly control of DHW recirculation.
- Integrated management of simultaneous heating/cooling emission, according to scheme.
- Integrated management of external On/Off or modulating auxiliary systems, such as electrical heaters, On/Off boilers or modulating boilers.
- Integrated active cooling.
- Selection of the indoor unit depending on the installation needs.
- Single-phase and Three-phase versions available.
- Integrated photovoltaic hybridisation.
- Integrated energy meters to measure the electrical consumption, the heating/cooling thermal power, the COP and the monthly and annual SPF.

SPECIFICATIONS ecoAIR+ 3-12 PRO		UNITS	
APPLICATION	Place of installation	-	Outdoors
	Type of brine system ¹	-	Air source
	DHW, Heating and Pool	-	✓
	Integrated Active cooling	-	✓
PERFORMANCE	Modulation range of the compressor	%	17 to 100
	Heating power output ² , A7W35	kW	3,0 to 11,0
	COP ² , A7W35	-	4,8
	Heating power output ² , A7W55	kW	3,0 to 10,0
	COP ² , A7W55	-	3,0
	Active cooling power output ² , A35W7	kW	1,8 to 8,6
	EER ² , A35W7	-	3,1
	Max. DHW temperature without / with support ⁵	°C	70 / 80
	Noise power emission level ⁶	db	57
	Energy label / rjs / SCOP W35 average climate control	-	A++ / 158% / 3,93
Energy label / rjs / SCOP W55 average climate control	-	A++ / 129% / 3,21	
OPERATION LIMITS	Distribution / Set heating outlet temperature range	°C	10 to 70 / 20 to 70
	Distribution / Set cooling outlet temperature range	°C	5 to 30 / 7 to 30
	Outdoor temperature range	°C	-22 to 50
	Minimum / Maximum refrigerant circuit pressure	bar	0,5 / 25,5
WORKING FLUIDS	Production circuit pressure	bar	0,5 to 3,0
	R290 Refrigerant load	kg	0,85
	Compressor oil type / load	kg	HXL4467 / 0,74
CONTROL ELECTRICAL DATA	Air flow (75% fan)	m ³ /h	3510
	1/N/PE 230 V / 50-60 Hz ⁸	-	✓
	Maximum recommended external protection ⁹	-	C5A
	Transformer primary circuit fuse	A	0,5
ELECTRICAL DATA: SINGLE-PHASE	Transformer secondary circuit fuse	A	2,5
	1/N/PE 230 V / 50-60 Hz ⁸	-	✓
	Maximum recommended external protection ⁹	-	C25A
	Maximum consumption ² , A7W35	kW / A	2,8 / 13,8
ELECTRICAL DATA: THREE-PHASE	Maximum consumption ² , A7W55	kW / A	3,5 / 17,7
	Minimum / Maximum starting current ⁷	A	4,5 / 5,4
	Correction of cosine Ø	-	0,93 / 1
	3/N/PE 400 V / 50-60Hz ⁸	-	✓
DIMENSIONS/WEIGHT	Maximum recommended external protection ⁹	-	C16A
	Maximum consumption ² , A7W35	kW / A	2,8 / 4,6
	Maximum consumption ² , A7W55	kW / A	3,5 / 5,9
	Minimum / Maximum starting current ⁷	A	1,5 / 1,8
DIMENSIONS/WEIGHT	Correction of cosine Ø	-	0,93 / 1
	Height x width x depth	mm	973x1150x475
DIMENSIONS/WEIGHT	Empty weight (without assembly)	kg	134

1. Outdoor air-to-water monobloc unit.
 2. In compliance with EN 14511, this includes the consumption of the circulation pumps and the compressor driver.
 3. Considering production flow rate in compliance with EN 14511.
 4. Considering a heat slope from 20°C to 50°C in absence of consumption.
 5. Considering support provided by the emergency electrical heater.
 6. In compliance with EN 12102.
 7. Starting current depends on the working conditions of the hydraulic circuits.
 8. The admissible voltage range for proper operation of the heat pump is ±10%.
 9. Maximum consumption can vary significantly according to working conditions, or if the compressor's operation range is restricted. Consult the technical service manual for more detailed information.
 10. Certification in process.

Dimensions and hydraulic connections

Indoor units

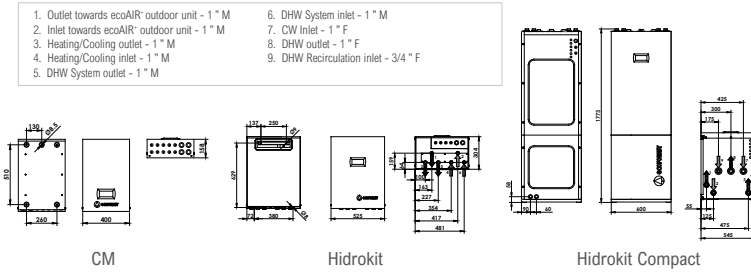

Outdoor unit - ecoAIR+

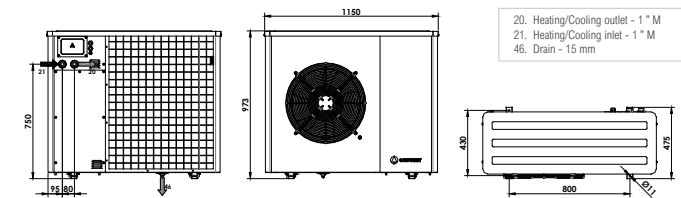

Operational chart

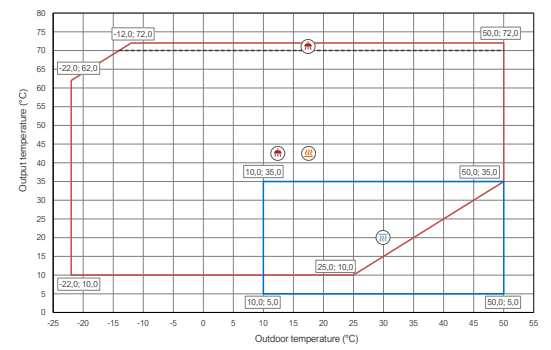

Installation management

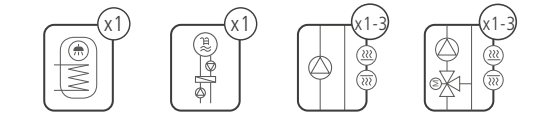

Performance curves

Thermal performance

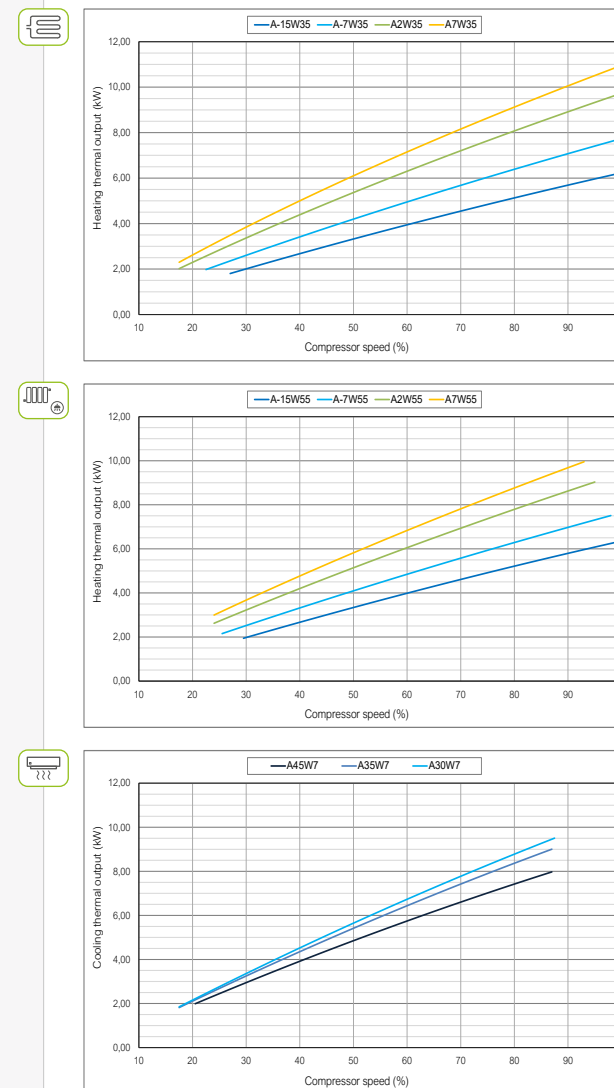

Hydraulic performance

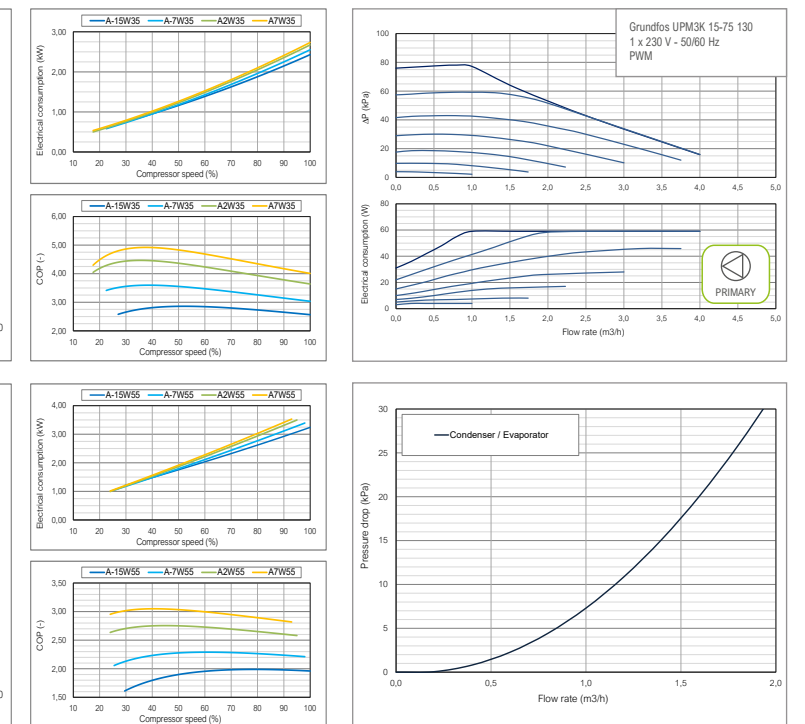

ecoAIR+ 3-18 PRO



- Modulating thermal power control within a wide range (17-100%) and modulating flow rate control of the production circuit (20-100%).
- Natural refrigerant R290 : GWP 3.
- Inverter technology and scroll compressor.
- Compact design including the production circulation pump in the outdoor unit. Hydraulic connection within the outdoor unit and the indoor unit.
- Integrated management of up to 3 different emission temperatures, 2 buffer tanks (heating and cooling), 1 DHW tank, 1 pool and hourly control of DHW recirculation.
- Integrated management of simultaneous heating/cooling emission, according to scheme.
- Integrated management of external On/Off or modulating auxiliary systems, such as electrical heaters, On/Off boilers or modulating boilers.
- Integrated active cooling.
- Selection of the indoor unit depending on the installation needs.
- Single-phase and Three-phase versions available.
- Integrated photovoltaic hybridisation.
- Integrated energy meters to measure the electrical consumption, the heating/cooling thermal power, the COP and the monthly and annual SPF.

SPECIFICATIONS ecoAIR+ 3-18 PRO		UNITS	
APPLICATION	Place of installation	-	Outdoors
	Type of brine system ¹	-	Air source
	DHW, Heating and Pool	-	✓
PERFORMANCE	Integrated Active cooling	-	✓
	Modulation range of the compressor	%	17 to 100
	Heating power output ² , A7W35	kW	3,5 to 18,0
	COP ² , A7W35	-	5,1
	Heating power output ² , A7W55	kW	4,7 to 15,9
	COP ² , A7W55	-	3,4
	Active cooling power output ² , A35W7	kW	2,8 to 13,6
	EER ² , A35W7	-	4,0
	Max. DHW temperature without / with support ⁵	°C	70 / 80
	Noise power emission level ⁶	db	57
OPERATION LIMITS	Energy label / rjs / SCOP W35 average climate control	-	A+++ / 179 % / 4,46
	Energy label / rjs / SCOP W55 average climate control	-	A++ / 142 % / 3,53
	Distribution / Set heating outlet temperature range	°C	10 to 70 / 20 to 70
	Distribution / Set cooling outlet temperature range	°C	5 to 30 / 7 to 30
	Outdoor temperature range	°C	-22 to 50
WORKING FLUIDS	Minimum / Maximum refrigerant circuit pressure	bar	0,5 / 25,5
	Production circuit pressure	bar	0,5 to 3,0
	R290 Refrigerant load	kg	1,37
CONTROL ELECTRICAL DATA	Compressor oil type / load	kg	HXL4467 / 0,74
	Air flow (75% fan)	m ³ /h	6771
	1/N/PE 230 V / 50-60 Hz ⁸	-	✓
ELECTRICAL DATA: SINGLE-PHASE	Maximum recommended external protection ⁹	-	C5A
	Transformer primary circuit fuse	A	0,5
	Transformer secondary circuit fuse	A	2,5
	1/N/PE 230 V / 50-60 Hz ⁸	-	✓
	Maximum recommended external protection ⁹	-	C32A
ELECTRICAL DATA: THREE-PHASE	Maximum consumption ² , A7W35	kW / A	4,2 / 18,3
	Maximum consumption ² , A7W55	kW / A	5,3 / 23,2
	Minimum / Maximum starting current ⁷	A	8,8
	Correction of cosine Ø	-	0,94 / 1
	3/N/PE 400 V / 50-60Hz ⁸	-	✓
DIMENSIONS/WEIGHT	Maximum recommended external protection ⁹	-	C16A
	Maximum consumption ² , A7W35	kW / A	4,2 / 6,7
	Maximum consumption ² , A7W55	kW / A	5,4 / 8,5
	Minimum / Maximum starting current ⁷	A	2,7 / 3,5
	Correction of cosine Ø	-	0,94 / 1
DIMENSIONS/WEIGHT	Height x width x depth	mm	1254x1350x625
	Empty weight (without assembly)	kg	175

1. Outdoor air-to-water monobloc unit.
 2. In compliance with EN 14511, this includes the consumption of the circulation pumps and the compressor driver.
 3. Considering production flow rate in compliance with EN 14511.
 4. Considering a heat slope from 20°C to 50°C in absence of consumption.
 5. Considering support provided by the emergency electrical heater.
 6. In compliance with EN 12102.
 7. Starting current depends on the working conditions of the hydraulic circuits.
 8. The admissible voltage range for proper operation of the heat pump is ±10%.
 9. Maximum consumption can vary significantly according to working conditions, or if the compressor's operation range is restricted. Consult the technical service manual for more detailed information.
 10. Certification in process.

Dimensions and hydraulic connections

Indoor units

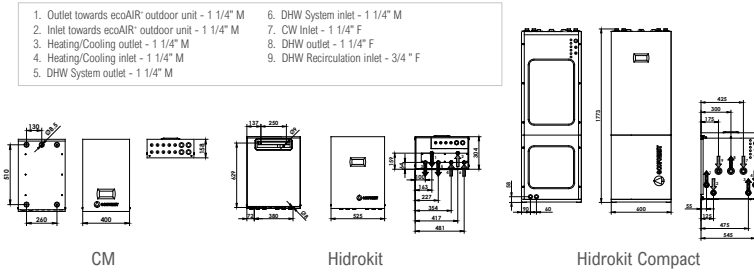

Outdoor unit - ecoAIR+

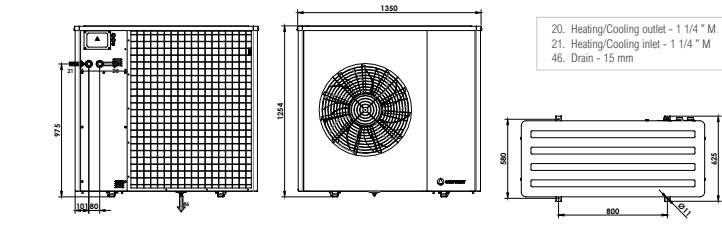

Operational chart

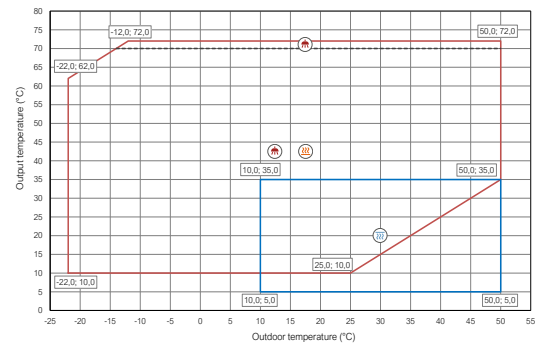

Installation management

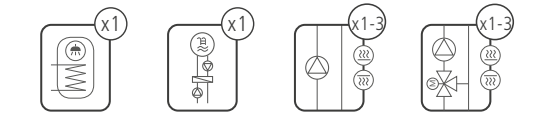

Performance curves

Thermal performance

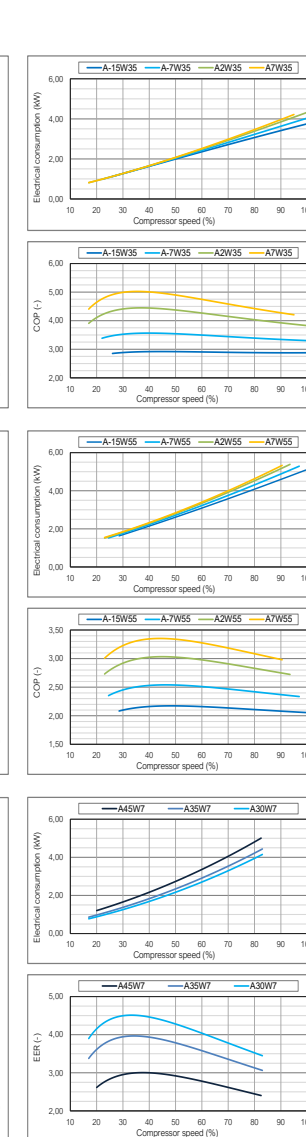
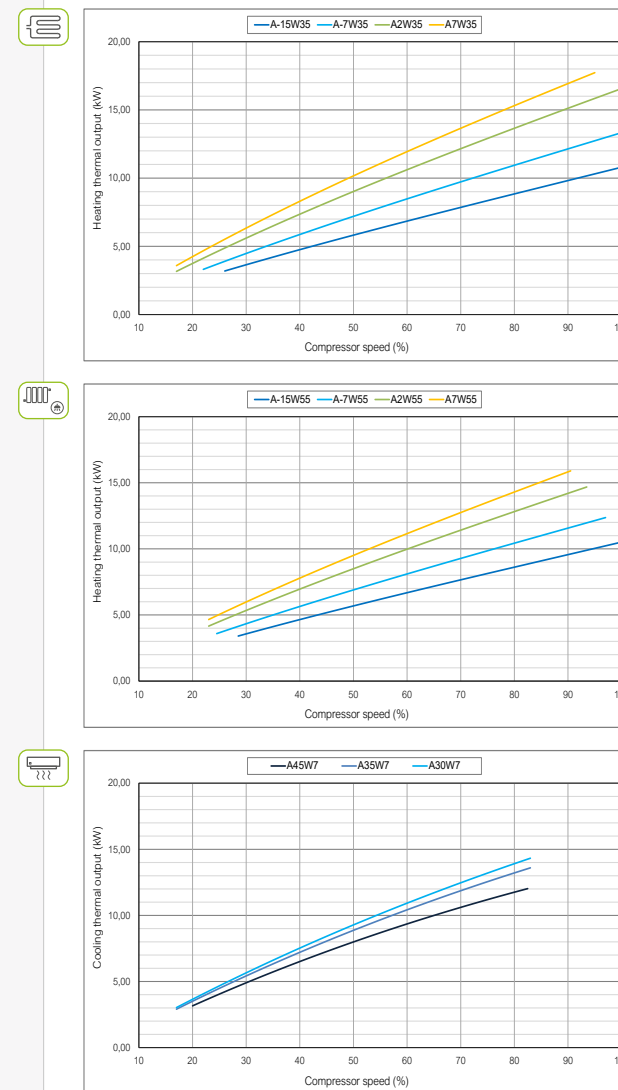

Hydraulic performance

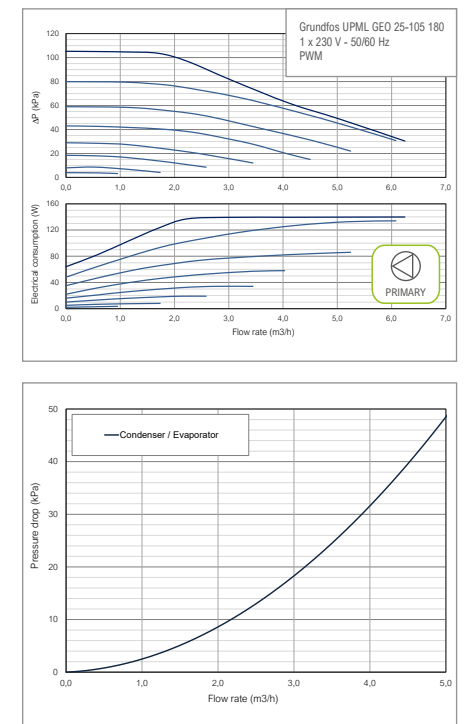

ecoAIR+ EVI

Residential range



Power ranges

ecoAIR+ EVI 4-20



Monobloc heat pump

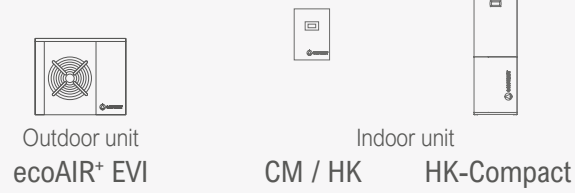

Services



DHW



Heating



Cooling



Pool

Indoor units

CM

Controller
Display

HK-EH

Controller
Display
Filling kit & filter
DHW 3-way valve
Support electrical heater

HK-Compact-EH

Controller
Display
Filling kit & filter
DHW 3-way valve
Support electrical heater
165l stainless steel DHW tank
Expansion vessel & safety valve



Inverter technology

Power ranges: 4-20 kW

Unique EVI technology by means of the Flash Tank system allowing to offer the best performances even in the most unfavourable conditions

Hot water production temperatures up to 65°C

Domestic hot water production

Heating and pool production

Integrated active cooling production

Modulating speed fan

Internet connection through the ecoSMART Easynet

Integrated photovoltaic hybridisation

Single-phase (230V) or three-phase (400V) power supply

Unique performances

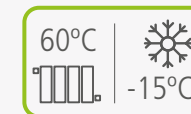

DHW production and Heating

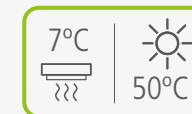

Cooling

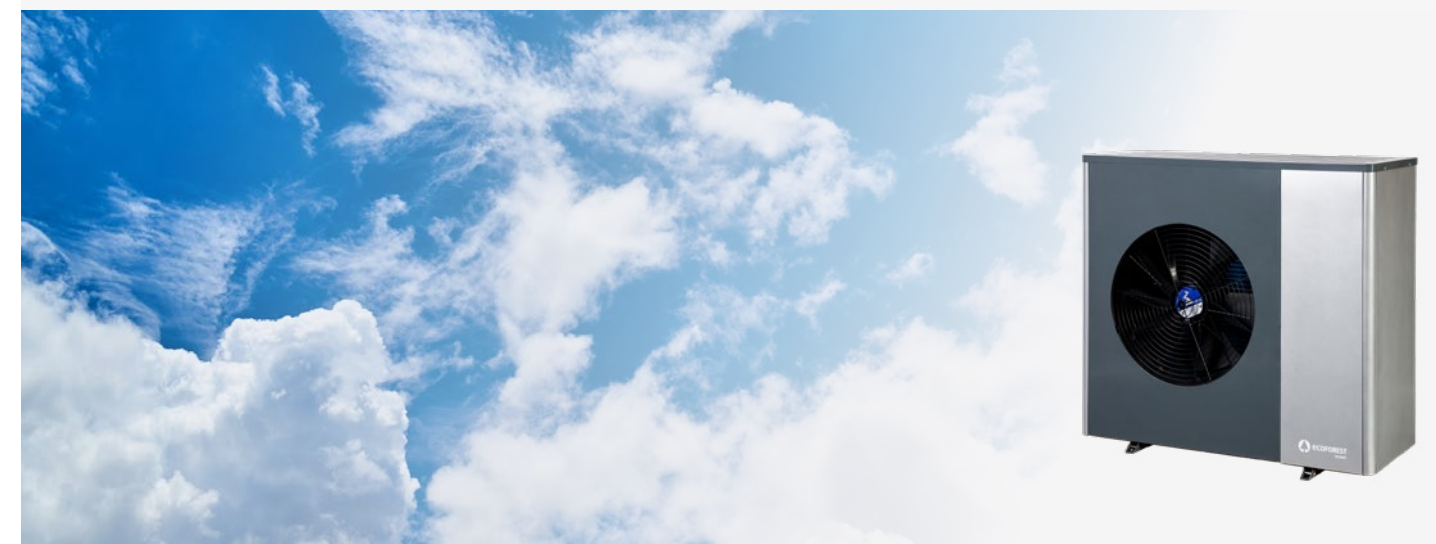

Indoor units

CM / HK / HK-Compact

- Indoor hydraulic units to be used in combination with ecoAIR+ EVI monobloc aérothermal heat pumps.
- CM, HK & HK-Compact: including the electrical box that allows to control the heat pump.
- HK & HK-Compact: including the main hydraulic components of the installation in several combinations.
- HK-Compact: integrating a 165l stainless steel DHW tank.
- Plug&play compact units that make the hydraulic system simpler and the installation easier.
- Single-phase control electrical box.
- Single-phase or Three-phase optional support electrical heater.

SPECIFICATIONS ecoAIR+ EVI INDOOR UNITS		UNITS	CM	HK	HK-Compact
				HK-EH	HK-Compact-EH
APPLICATION	Place of installation	-		Indoors	
	DHW	-	✓	✓	✓
	Heating and Pool	-	✓	✓	✓
	Cooling	-	✓	✓	✓
INTEGRATED HYRAULIC COMPONENTS	Filling kit and filter	-	-	✓	✓
	DHW three-way valve	-	-	✓	✓
	Support electrical heater	-	-	✓	✓
	Separation plate heat exchanger	-	-	-	-
	Secondary circuit circulation pump	-	-	-	-
	Stainless steel DHW tank	-	-	-	✓
	Primary / Secondary expansion vessel	-	-	-	✓ (12l)
OPERATION LIMITS	Production circuit pressure	bar	-	0,5 - 3,0	
	DHW tank volume	l	-	-	165
	DHW tank maximum pressure	bar	-	-	8,0
CONTROL ELECTRICAL DATA	DHW tank maximum temperature	°C	-	-	80
	1/N/PE 230 V / 50-60 Hz ¹	-	-	✓	
	Recommended external protection	-	-	C16A	
	Transformer primary circuit fuse	A	-	0,5	
ELECTRICAL DATA: INTEGRATED SUPPORT ELECTRICAL HEATER	Transformer secondary circuit fuse	A	-	2,5	
	Supply: 1/N/PE 230Vac / 50-60 Hz ¹	-	-	✓	
	Number of elements	-	-	1-2-3	
	Recommended external protection 1-2-3	-	-	C10A-C16A-C20A	
	Maximum power consumption 1-2-3	kW	-	1,3-2,7-4,0	
	Maximum current consumption 1-2-3	A	-	6,3-12,6-18,9	
	Supply: 3/N/PE 400Vac / 50-60 Hz ¹	-	-	✓	
	Recommended external protection	-	-	C10A	
	Maximum power consumption	kW	-	4,0	
	Maximum current consumption	A	-	6,3	
DIMENSIONS/WEIGHT	Correction of cosine Ø	-	-	0,96 / 1	
	Height x width x depth	mm	600x400x158	713x525x304	1773x600x679
	Empty weight (without assembly)	kg	15	40	130

1. The admissible voltage range for proper operation of the heat pump is ±10%.

Dimensions and hydraulic connections

Indoor units

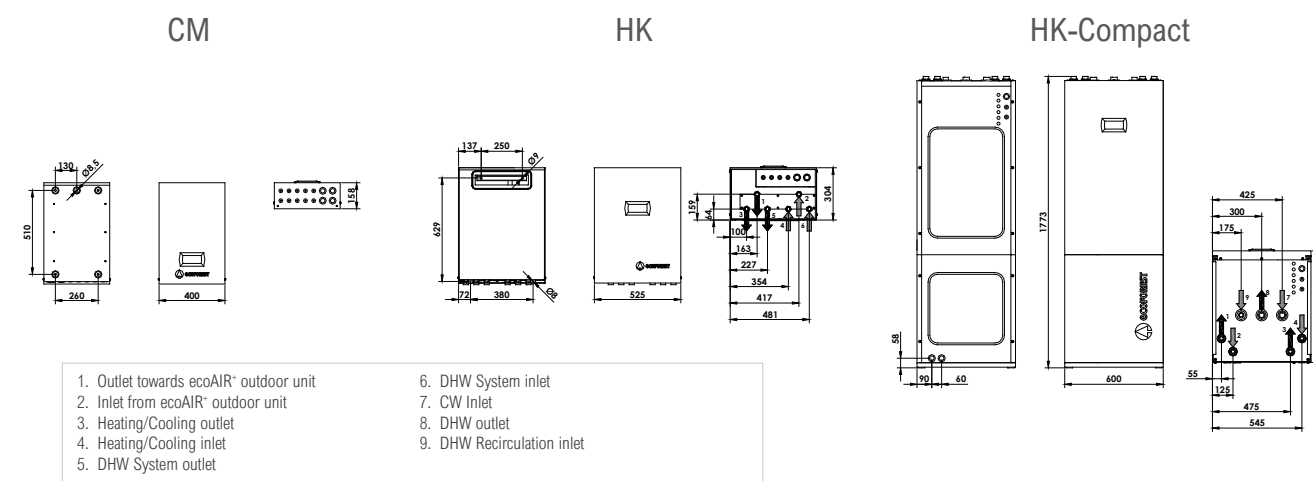

Hydraulic characteristics

Hydraulic layouts

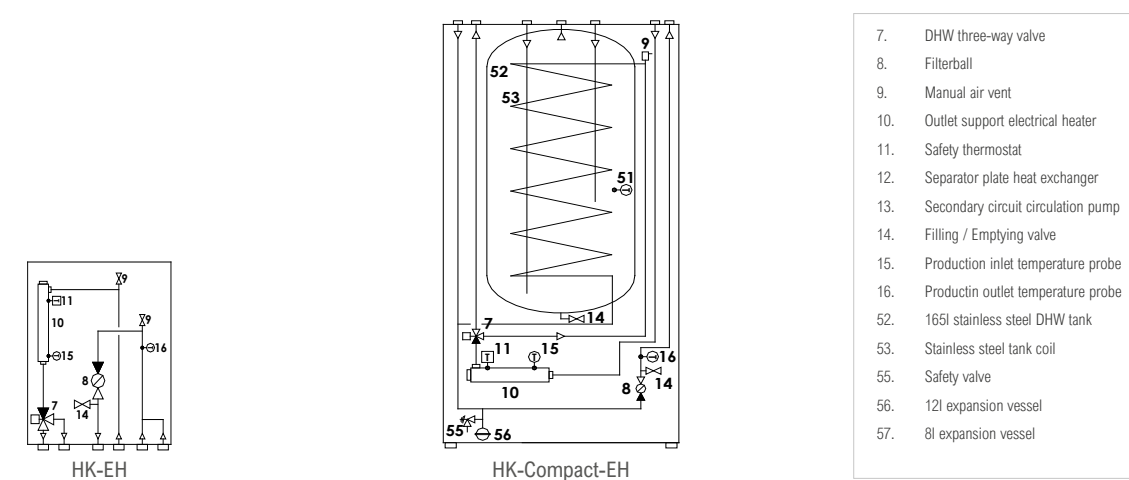

ecoAIR+ EVI 4-20

- Modulating thermal power control within a wide range (17-100%) and modulating flow rate control of the production circuit (20-100%).
- EVI technology by means of Flash Tank system.
- Inverter technology and scroll compressor.
- Compact design including the production circulation pump in the outdoor unit. Hydraulic connection within the outdoor unit and the indoor unit.
- Integrated management of up to 3 different emission temperatures, 2 buffer tanks (heating and cooling), 1 DHW tank, 1 pool and hourly control of DHW recirculation.
- Integrated management of simultaneous heating/cooling emission, according to scheme.
- Integrated management of external On/Off or modulating auxiliary systems, such as electrical heaters, On/Off boilers or modulating boilers.
- Integrated active cooling.
- Selection of the indoor unit depending on the installation needs.
- Single-phase and Three-phase versions available.
- Integrated photovoltaic hybridisation.
- Integrated energy meters to measure the electrical consumption, the heating/cooling thermal power, the COP and the monthly and annual SPF.

SPECIFICATIONS ecoAIR+ EVI 4-20		UNITS	
APPLICATION	Place of installation	-	Outdoors
	Type of brine system ¹	-	Air source
	DHW, Heating and Pool	-	✓
	Integrated Active cooling	-	✓
PERFORMANCE	Modulation range of the compressor	%	17 to 100
	Heating power output ² , A7W35	kW	4,0 to 20,5
	COP ² , A7W35	-	5,0
	Heating power output ² , A7W55	kW	8,8 to 20,8
	COP ² , A7W55	-	3,3
	Active cooling power output ² , A35W7	kW	4,0 to 14,8
	EER ² , A35W7	-	3,3
	Max. DHW temperature without / with support ⁵	°C	63 / 80
	Noise power emission level ⁶	db	63
	Energy label / rjs / SCOP W35 average climate control	-	A+++ / 184% / 4,57
Energy label / rjs / SCOP W55 average climate control	-	A+++ / 155% / 3,84	
OPERATION LIMITS	Distribution / Set heating outlet temperature range	°C	10 to 63 / 20 to 60
	Distribution / Set cooling outlet temperature range	°C	5 to 30 / 7 to 30
	Outdoor temperature range	°C	-22 to 50
	Minimum / Maximum refrigerant circuit pressure	bar	2,0 / 45,0
WORKING FLUIDS	Production circuit pressure	bar	0,5 to 3,0
	R410A Refrigerant load	kg	3,5
	Compressor oil type / load	kg	POE / 1,18
	Air Flow (75% fan)	m ³ /h	6771
CONTROL ELECTRICAL DATA	1/N/PE 230 V / 50-60 Hz ⁸	-	✓
	Maximum recommended external protection ⁹	-	C5A
	Transformer primary circuit fuse	A	0,5
	Transformer secondary circuit fuse	A	2,5
ELECTRICAL DATA: SINGLE-PHASE	1/N/PE 230 V / 50-60 Hz ⁸	-	✓
	Maximum recommended external protection ⁹	-	C40A
	Maximum consumption ² , A7W35	kW / A	5,3 / 23,0
	Maximum consumption ² , A7W55	kW / A	7,8 / 34,1
	Minimum / Maximum starting current ⁷	A	10,8
ELECTRICAL DATA: THREE-PHASE	Correction of cosine Ø	-	0,87 / 1
	3/N/PE 400 V / 50-60Hz ⁸	-	✓
	Maximum recommended external protection ⁹	-	C16A
	Maximum consumption ² , A7W35	kW / A	5,3 / 7,7
	Maximum consumption ² , A7W55	kW / A	7,8 / 11,4
DIMENSIONS/WEIGHT	Minimum / Maximum starting current ⁷	A	3,6
	Correction of cosine Ø	-	0,87 / 1
	Height x width x depth	mm	1254x1350x625
	Empty weight (without assembly)	kg	177

1. Outdoor air-to-water monobloc unit.
 2. In compliance with EN 14511, this includes the consumption of the circulation pumps and the compressor driver.
 3. Considering production flow rate in compliance with EN 14511.
 4. Considering a heat slope from 20°C to 50°C in absence of consumption.
 5. Considering support provided by the emergency electrical heater.
 6. In compliance with EN 12102.
 7. Starting current depends on the working conditions of the hydraulic circuits.
 8. The admissible voltage range for proper operation of the heat pump is ±10%.
 9. Maximum consumption can vary significantly according to working conditions, or if the compressor's operation range is restricted. Consult the technical service manual for more detailed information.
 10. Certification in process.

Dimensions and hydraulic connections

Indoor units

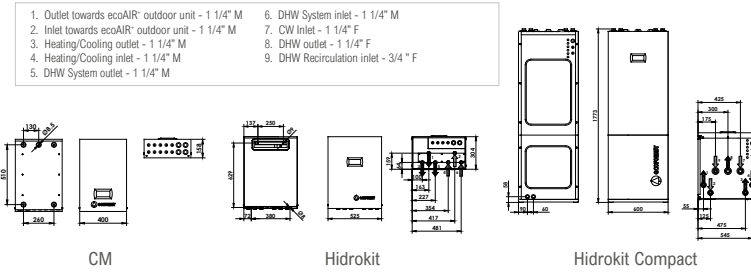

Outdoor unit - ecoAIR+

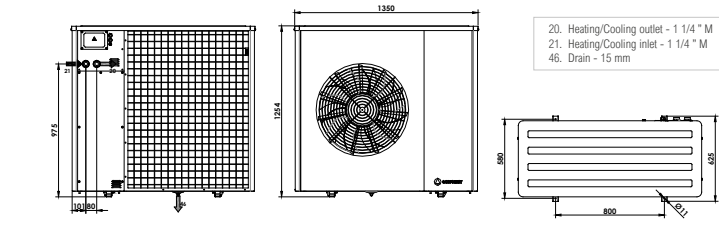

Operational chart

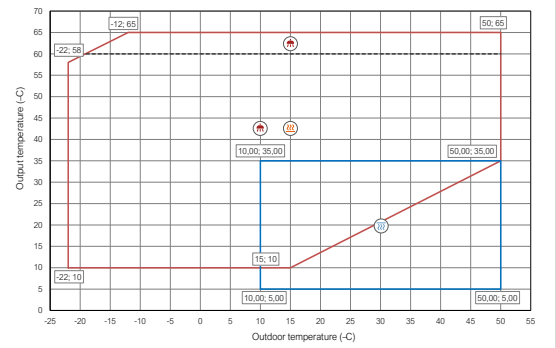

Installation management

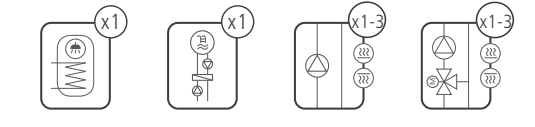

Performance curves

Thermal performance

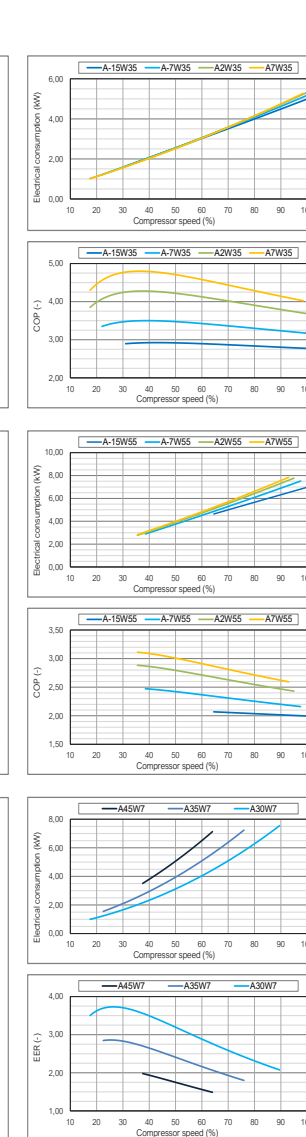
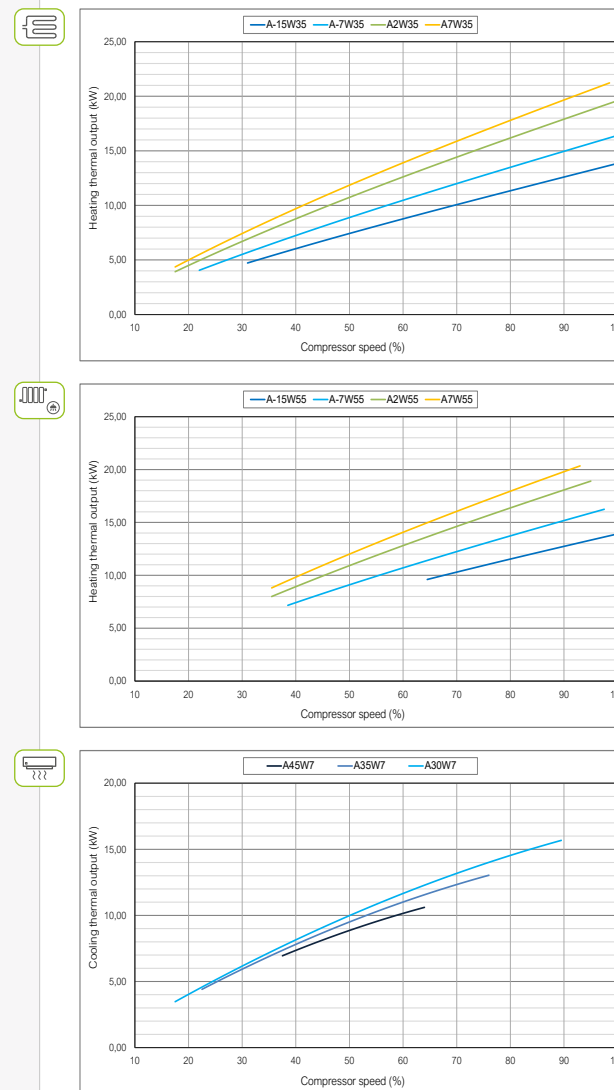

Hydraulic performance

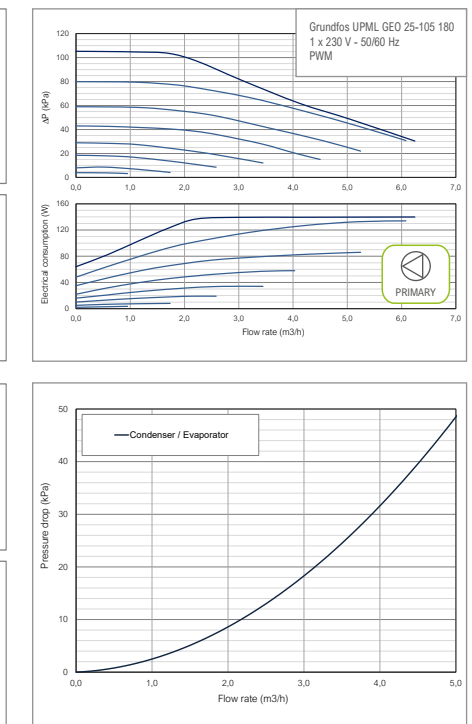

ECOFORREST GEOTERMIA, S.L.

Parque Empresarial Porto do Molle · Rúa das Pontes 25
36350 Nigrán - Pontevedra (Spain)

+34 986 262 184

www.ecoforest.com



v2022_01



Ecoforest shall not be held responsible for any error contained in this these technical data sheets and reserves the right to make any modifications it deems necessary for both technical and commercial reasons at any time and without prior notification. The availability of any equipment described in this document shall always be confirmed by Ecoforest. The inclusion of the equipment in this catalogue does not imply an immediate availability.

